

Fuel Pump Testing - 65 RS

Before replacing a suspect fuel pump, remove and clean the fuel filter and install a new filter element. Also remove the fuel line from the fuel tank and blow through all passages and lines with low-pressure, compressed air to be sure they are open. This may be the cause of inadequate fuel delivery and, if so, would eliminate unnecessary replacement of the fuel pump. If this procedure does not correct the trouble, fuel pump is probably malfunctioning and should be replaced.

Note To prevent excessive fuel spillage, disconnect line connector at motor before disassembly.

! After servicing, check for leaks by connecting fuel line to motor and squeezing primer bulb until definite resistance is felt in bulb.

1 To install a new filter element, loosen screw and remove cover **A**. Do not lose small O-ring **D** from around center post or large O-ring **C** from outer edge of cover.

1

- Wash filter element **B** with clean solvent and a brush.

- Install filter with lip facing toward fuel pump body.

1

- Make sure the large O-ring **C** is seated in its groove in the cover and the small O-ring **D** is in place around center post.

1

- Install cover **A**. Position inlet nipple between screw heads.

- Tighten the cover screw securely.

Function Test

Conduct this test with the motor in a test tank or on the boat.

Before testing, loosen fuel tank gas cap momentarily to release any pressure that may have built up. Fuel tank must not be more than 30 in. (76 cm) below fuel pump.

2 1. Remove carburetor to fuel pump hose. Connect a fuel pressure gauge between the carburetor and fuel pump.

2. Start motor and observe gauge. Refer to chart for pump pressures.

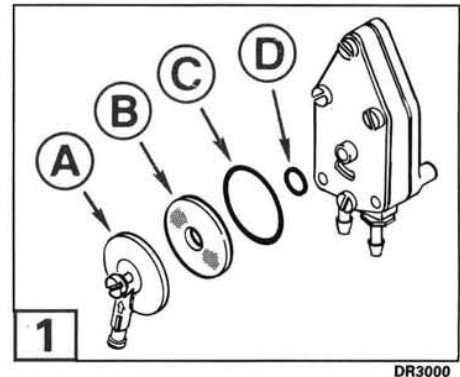

RPM	Pressure	
	PSI	kPa
600	1	7
2500-3000	1.5	10
4500	2.5	17

DR1468

3. If fuel pump does not meet these specifications, replace fuel pump.

- When installing a new fuel pump, apply *OMC Nut Lock* to threads of screws. Install and tighten screws to a torque of 24-36 in. lbs. (2,8-4,0 N·m).

In-line Fuel Filter Servicing

Commercial Models

3 1. Unscrew in-line filter cover **C**. It is not necessary to remove fuel hoses to service filter.

3 2. Clean filter canister **D** and shake filter element to remove collected particles.

3. Clean all parts of the filter assembly and fuel connectors with a mild aerosol solvent and blow dry. DO NOT dry parts with a cloth as lint might stick to the parts and clog the passages. Dissolve any gummy deposits with *OMC Cleaning Solvent*.

Recreational Models

4 Replace the filter during the 20-Hour Check. Thereafter, change the filter seasonally or every 100 hours.

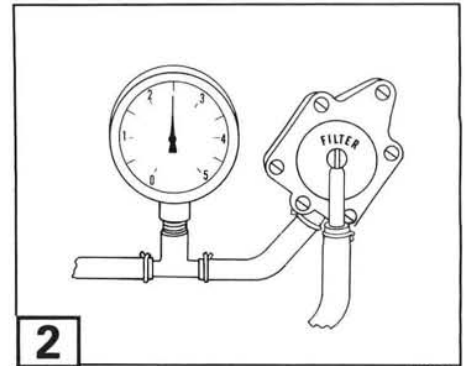

63328

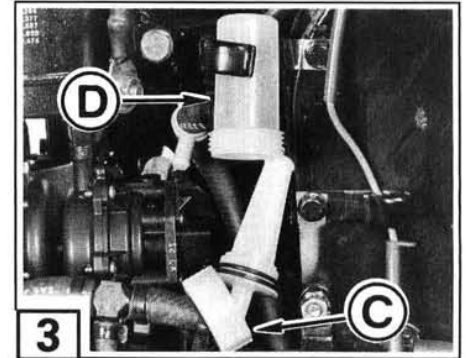

9527

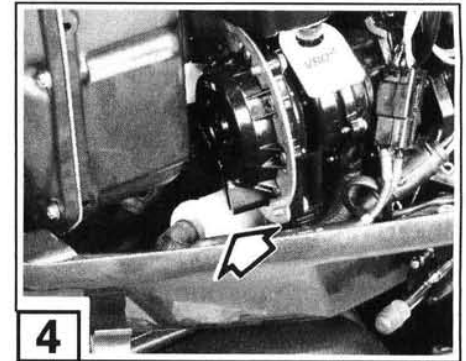

16701

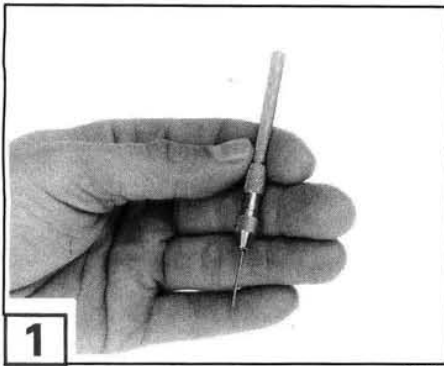

6784

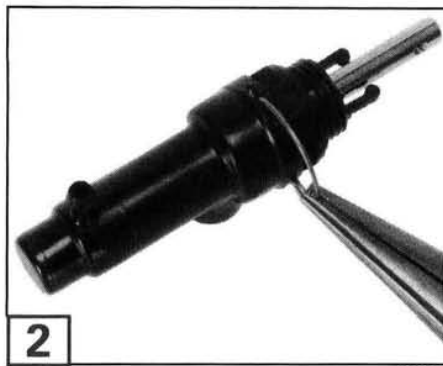

29284

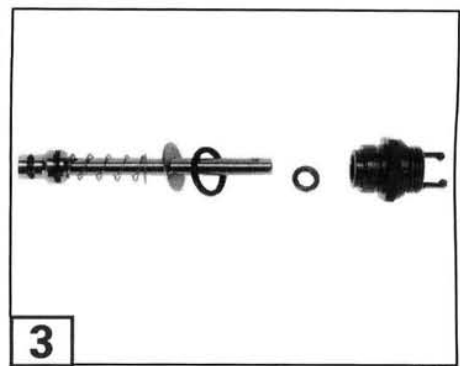

29283

Manual Primer Servicing - 65 RS

Functional Tests

1. Remove primer hose from nipple in carburetor. Install hose end into a suitable container to catch fuel.
2. Squeeze fuel tank primer bulb to fill carburetor bowls with fuel.
3. Operate primer pump twice. Fuel should squirt from the hoses into the container indicating primer is functioning.

1 4. Inspect primer nipple to ensure nipple is free of obstructions. Use *OMC Nipple Cleaner* P/N 326623 to clean the metering hole in nipple. The nipple is pressed into the carburetor body and serviced with the body.

5. If primer pump fails to pump fuel from hoses, a restricted or kinked hose or inoperative primer pump may be the cause.

6. Operate primer pump and watch for fuel squirting from hose. If fuel squirts from hose, primer pump is okay; if not, proceed to next step.

7. Remove hose at small nipple on top side of primer pump. Inspect hose for kinks or obstructions to flow. Operate primer pump. Fuel should squirt from small nipple.

8. If primer pump fails to pump, inspect inlet hose between primer pump and carburetor for kinks and obstructions.

9. If hose is open and not kinked, remove and disassemble primer pump assembly. If the primer pump was not working in the above test or is externally leaking, replace the O-rings.

Note The three smaller O-rings are made with a special material; use only the proper O-rings.

Disassembly.

1. Disconnect fuel hoses and remove from engine.
- 2** 2. Remove primer pump housing retainer from primer pump.
- 3** 3. Remove primer plunger from housing. Discard O-rings.

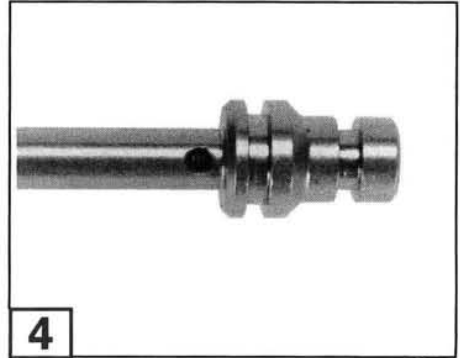

29282

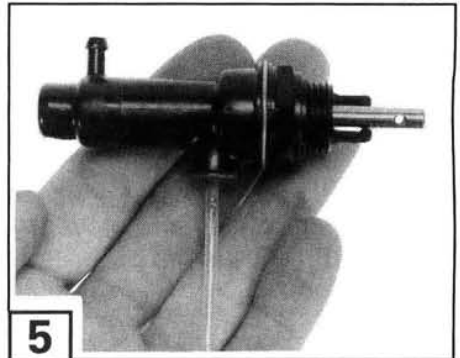

29275

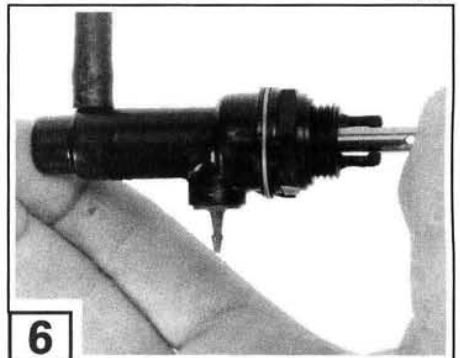

29276

Inspection

4 1. Inspect brass plunger shaft for any burrs or scratches. Remove small scratches by polishing the plunger with crocus cloth. If the plunger has deep scratches, replace the plunger.

2. Inspect plunger where cross hole intersects inside hole. Any burrs around cross hole will accelerate wear of O-rings. Remove any protruding burrs and polish with crocus cloth.

3. The check valve under the small nipple on the primer pump housing allows fuel flow out of the pump housing and prevents flow into the housing.

5 4. To check valve function, use a small syringe filled with isopropyl alcohol. Connect a clear plastic hose between small nipple and syringe to observe flow of alcohol. Squeeze the syringe lightly to force alcohol through the hose. Visually check for flow of alcohol into the housing. It is permissible for a few drops to be present. This indicates the check valve is blocking the flow and functioning correctly. If a steady stream of alcohol flows through the small nipple, the check valve is inoperative and the primer pump housing must be replaced.

6 5. Install a hose between the large nipple of the primer pump housing and the syringe. Place your thumb over end of the plunger housing. Squeeze the syringe to fill the plunger housing. Alcohol should flow freely out of the small nipple, indicating no obstructions. If no flow is indicated, replace primer pump housing.

Assembly

7 1. Position the spring and washer on the plunger shaft.

8 2. Install two new O-rings **A** and quad-ring **B** onto plunger shaft.

9 3. Install a new O-ring onto the end cap and position the end cap on the plunger shaft.

10 4. Insert plunger shaft and end cap into primer pump housing. Reinstall retainer clip.

11 5. To bench test the primer pump after assembly, connect a five-inch piece of hose to the large nipple and place the other end of hose in a container of alcohol. Place a hose on the small nipple and place other end of hose to drain into a container. Hold primer pump in horizontal position as it would be installed on the engine. Move plunger back and forth ten times. Primer should pump approximately 10 cc of alcohol in ten strokes. If pump fails to pump alcohol, disassemble and check for missing, cut, or split O-rings or damaged check valves.

! 6. After installing, check for leaks by connecting fuel tank line to motor and squeezing primer bulb until definite pressure is felt in the bulb.

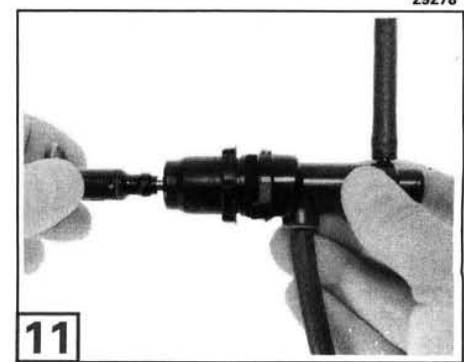
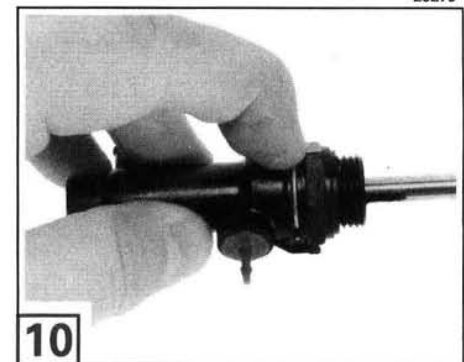
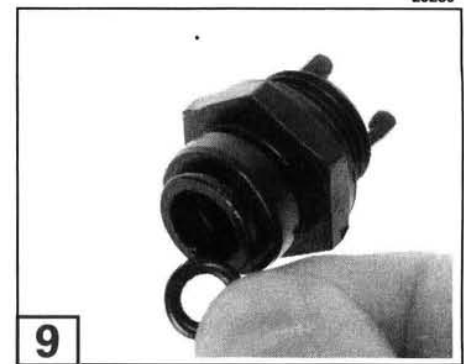
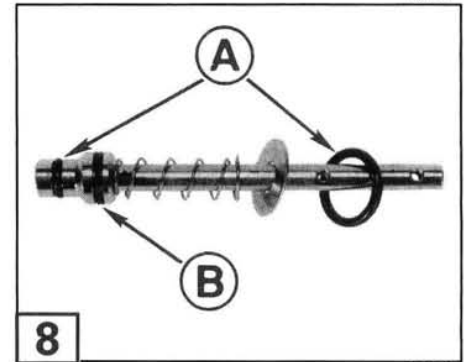
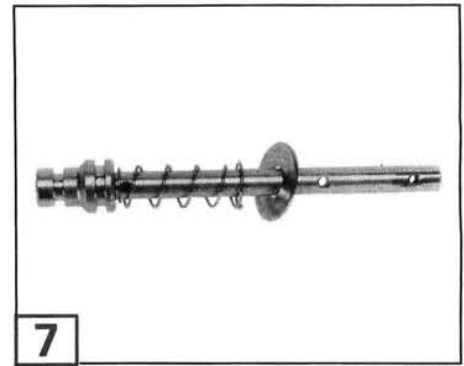

Primer System Servicing - VRO² Models

Functional Test

1. Start engine and allow it to reach normal operating temperature. Set engine speed at 2000 RPM.

- 1 2. While engine is running, push in key.
- Engine should run richly and drop 1000 RPM.

- 2 3. Remove air silencer assembly.

- 3 4. Remove primer hose from any intake manifold or carburetor primer fitting that you suspect is clogged. Connect a 1/8 inch I.D. clear vinyl hose between the fitting and a syringe filled with isopropyl alcohol.

- 3 5. Press lightly on the syringe.
- If fluid moves through the fitting, it is okay.

- 4 • If fluid does not move through the fitting, clean with OMC Cleaning Tool P/N 326623.

Solenoid Removal

1. Remove the two bracket screws and remove the primer solenoid. Carefully remove the three hoses.

2. Remove the terminal screw and remove the purple/white lead.

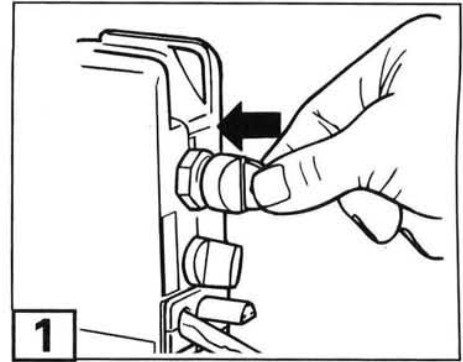

803323

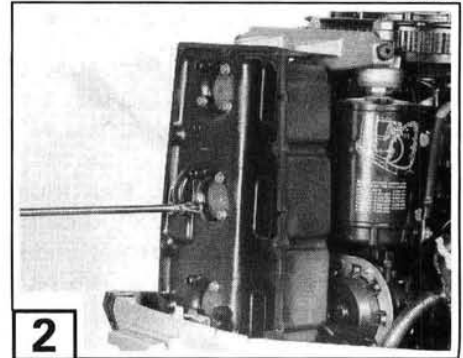

9531

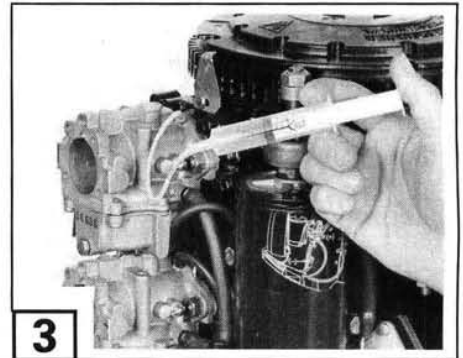

9440

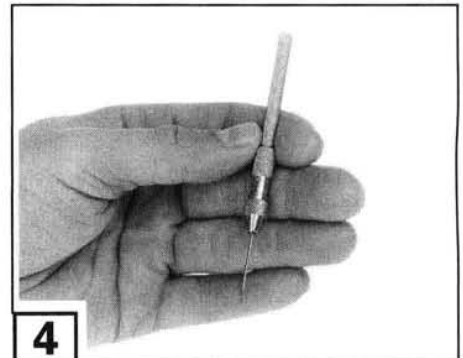

6784

Inspection

5 1. To test the solenoid windings, calibrate an ohmmeter on low ohms scale and connect between the purple/white and black leads.

- Meter should indicate 5.5 ± 1.5 ohms.

6 2. To test solenoid valve and seat:

- Lightly pressurize inlet fitting with alcohol and syringe.
- With lever in **run** position, no fluid should enter inlet fitting.
- With lever in **prime** position, fluid should come out both outlet fittings.

7 3. To inspect or replace internal components, remove the four solenoid cover screws.

8 4. When assembling solenoid, back up screws in their holes to engage original threads and tighten securely.

Installation

1. Attach purple/white leads and three hoses. Secure large hose with tie strap.

2. Install solenoid and bracket. Position ground lead under the inside bracket screw.

! 3. Check for leaks by connecting fuel tank line to motor and squeezing primer bulb until definite pressure is felt in the bulb.

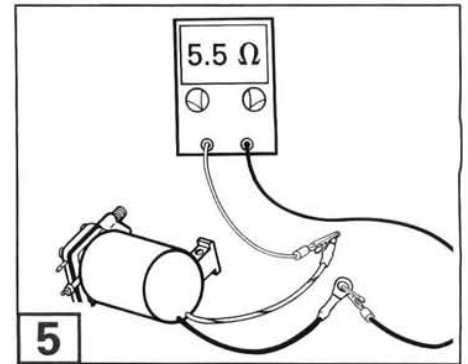

DR4034

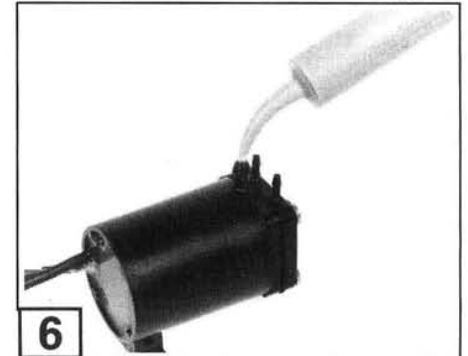

COA1138

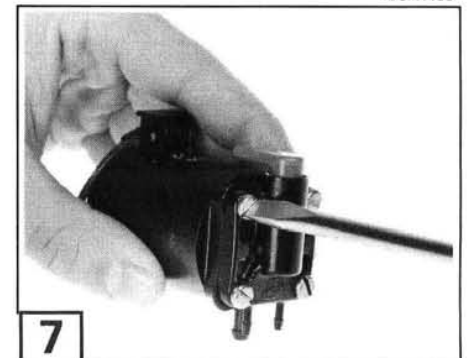

6783

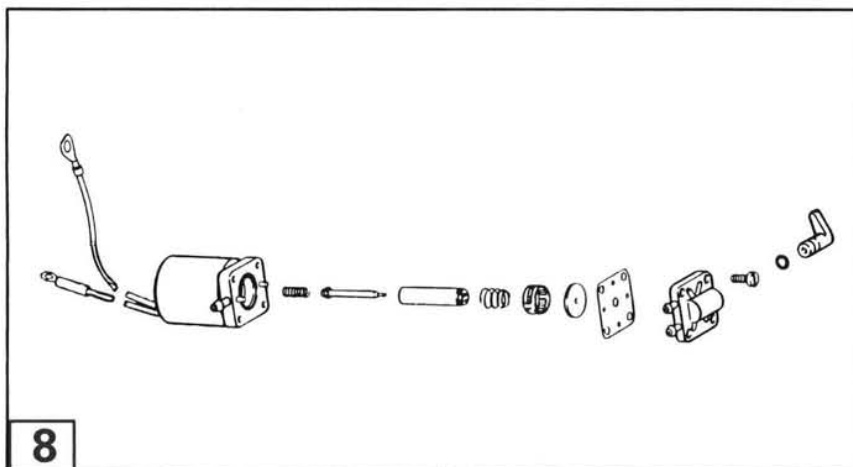

DR1417

