

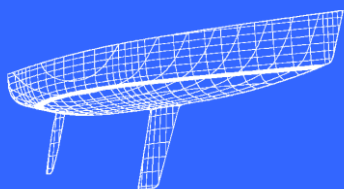

World Leader in Rating Technology

OFFSHORE RACING CONGRESS



**ORC VPP Documentation
2015**

Copyright © 2015 Offshore Racing Congress.

All rights reserved. Reproduction in whole or in part is only with the permission of the Offshore Racing Congress.

Cover picture: Wind tunnel testing at Politecnico Milano
by courtesy Dobbs Davis

1 *Background*

The following document describes the methods and formulations used by the Offshore Racing Congress (ORC) Velocity Prediction Program (VPP).

The ORC VPP is the program used to calculate racing yacht handicaps based on a mathematical model of the physical processes embodied in a sailing yacht. This approach to handicapping was first developed in 1978. The H. Irving Pratt Ocean Racing Handicapping project created a handicap system which used a mathematical model of hull and rig performance to predict sailing speeds and thereby produce a time on distance handicap system. This computational approach to yacht handicapping was of course only made possible by the advent of desktop computing capability.

The first 2 papers describing the project were presented to the Chesapeake Sailing Yacht Symposium (CSYS) in 1979¹. This work resulted in the MHS system that was used in the United States. The aerodynamic model was subsequently revised by George Hazen² and the hydrodynamic model was refined over time as the Delft Systematic Yacht Hull Series was expanded³.

Other research was documented in subsequent CSYS proceedings: sail formulations (2001⁴ and 2003⁵), and hull shape effects (2003⁶). Papers describing research have also been published in the HISWA symposia on sail research (2008⁷).

In 1986 the current formulations of the IMS were documented by Charlie Poor⁸, and this was updated in 1999⁹. The 1999 CSYS paper was used a basis for this document, with members of the ITC contributing the fruits of their labours over the last 10 years as the ORC carried forward the work of maintaining an up-to-date handicapping system that is based on the physics of a sailing yacht.

¹ "A summary of the H. Irving Pratt Ocean race Handicapping Project". (Kerwin, J.E. & Newman, J.N.) "The Measurement Handicapping System of USYRU" (Stromhmeier, D.D)

² Hazen, G., "A Model of Sail Aerodynamics for Diverse Rig Types," New England Sailing Yacht Symposium. New London, CT, 1980.

³ 1993, CSYS The Delft Systematic Yacht Hull (Series II) Experiments. Gerritsma, Prof. ir. J., Keuning, Ir. J., and Onnink, A. R.

⁴ Aerodynamic Performance of Offwind Sails Attached to Sprints. Robert Ranzenbach and Jim Teeters

⁵ Changes to Sail Aerodynamics in the IMS Rule Jim Teeters, Robert Ranzenbach and Martyn Prince

⁶ Aerodynamic Performance of Offwind Sails Attached to Sprints. Robert Ranzenbach and Jim Teeters

⁷ Fossati F., Claughton A., Battistin D., Muggiasca S.: "Changes and Development to Sail Aerodynamics in the ORC International Rule" – 20th HISWA Symposium, Amsterdam, 2008

⁸ "The IMS, a description of the new international rating system" Washington DC 1986

⁹ Claughton, A., "Developments in the IMS VPP Formulations," SNAME 14th CSYS, Annapolis, MD, 1999.

1.1 Contents

1	Background.....	3
1.1	Contents.....	4
1.2	Revision List.....	7
1.2.1	2012	7
1.2.2	2013	7
1.2.3	2014	7
1.2.4	2015	8
2	Introduction	9
2.1	Scope	9
2.2	Overview.....	9
2.3	Layout.....	9
3	VPP Methodology	10
3.1	Solution Method.....	10
3.2	Boat Model	11
3.2.1	Functional relationships	12
3.3	Equations of Equilibrium	14
3.3.1	Driving Force – Drag	14
3.3.2	Heeling Moment – Rolling Moment	15
3.4	Water Ballast and Canting Keel Yachts.....	16
3.4.1	Canting Keel	16
3.4.2	Daggerboard (Centreline lifting appendage)	16
3.4.3	Bilge boards (lifting boards off centreline)	16
3.4.4	Water ballast	17
3.4.5	Measurement	17
3.5	Dynamic Allowance (DA).....	17
3.5.1	Credits (2012)	18
3.5.2	Calculation Procedure	18
4	Lines Processing Program.....	20
4.1	Hydrostatics	20
4.2	LPP Output parameter definitions	20
4.2.1	Measurement Trim	21
4.2.2	Sailing Trim	21
4.2.3	Second Moment Length (LSM)	21
4.2.4	Appendage stripping	22
4.2.5	Beam Depth Ratio (BTR)	22
4.2.6	Maximum Effective Draft (MHSD).....	23
4.2.7	Bulb/Wing Effects	25
4.3	Appendage wetted areas and lengths.....	27
4.3.1	Conventional Fin keel and rudder	27
4.3.2	Other appendages	27
4.4	Righting Moment.....	28
4.4.1	Righting Arm Curve	28
4.4.2	Hydrodynamic Centre of Pressure	29
4.4.3	Crew righting moment	29
4.4.4	Dynamic Righting Moment. RMV	29
4.4.5	Rated Righting Moment	30

5	<i>Aerodynamic Forces</i>	31
5.1	Methodology	31
5.1.1	<i>Individual Sail Areas and 2-Dimensional Aerodynamic Force Coefficients</i>	31
5.1.2	<i>“Simplified” Rigging Coefficients</i>	33
5.1.3	<i>De-powering</i>	33
5.2	Sail Areas & Coefficients	34
5.2.1	<i>Mainsail</i>	34
5.2.2	<i>Jib or Genoa</i>	38
5.2.3	<i>Spinnakers</i>	40
5.2.4	<i>Spinnaker tack position “Power” Function</i>	43
5.2.5	<i>Headsails set flying</i>	44
	<i>Loose luffed</i>	45
5.3	Windage Forces	47
5.3.1	<i>Rigging</i>	48
5.4	Total Aerodynamic Lift and Drag	48
5.4.1	<i>Lift and Drag of complete sail set</i>	48
5.4.2	<i>Center of Effort Height</i>	49
5.4.3	<i>Induced Drag</i>	50
5.5	Resolution of Forces	53
5.5.1	<i>PHI_UP</i>	53
5.5.2	<i>Twist Function</i>	53
5.5.3	<i>Thrust and Heeling Force</i>	54
5.5.4	<i>Aerodynamic heeling Moment</i>	54
6	<i>Hydrodynamic Forces</i>	55
6.1	Viscous Resistance	55
6.1.1	<i>Canoebody</i>	55
6.1.2	<i>Appendages</i>	55
6.2	Propeller	58
6.2.1	<i>Shaft installation</i>	58
6.2.2	<i>Strut drive</i>	59
6.2.3	<i>In an aperture</i>	59
6.2.4	<i>Tractor propellers</i>	60
6.2.5	<i>Twin screws</i>	60
6.3	Residuary Resistance	60
6.3.1	<i>Resistance Surfaces</i>	60
6.3.2	<i>Composite Length Calculation</i>	61
6.4	Drag due to heel	63
6.4.1	<i>Induced Drag</i>	63
6.4.2	<i>Rail-under drag</i>	70
6.5	Added Resistance in Waves, R_{AW}	70
6.5.1	<i>Wave Climate</i>	70
6.5.2	<i>Determination of added resistance response</i>	71
7	<i>Environment</i>	75
7.1	Wind Triangle	75
7.2	Sailing Angles	75
7.2.1	<i>Velocity Made along the Course. (VMC)</i>	76
8	<i>Handicapping</i>	77
8.1	VPP results as used for scoring	77
8.1.1	<i>Velocity prediction</i>	77
8.1.2	<i>Time allowances</i>	77

8.2	Simple scoring options.....	78
8.2.1	<i>Time on Distance</i>	78
8.2.2	<i>Time on Time (ToT)</i>	79
8.2.3	<i>Performance line</i>	79
8.2.4	<i>Triple Number</i>	79
8.2.5	<i>OSN (Offshore Single Number) handicap</i>	80
8.2.6	<i>Class Division Length (CDL)</i>	80
9	Appendix A: Offset File (.OFF) Format.....	82

List of Figures

Figure 1 - Force Balance See-saw	10
Figure 2 - Force balance in the plane of the water surface	10
Figure 3 - Roll Moment Equilibrium	11
Figure 4 - Schematic of ORC VPP	12
Figure 5 - Functional Relationships in the VPP Boat Model.....	13
Figure 6 - DA Credit vs. True wind angle	19
Figure 7 - Offset file station distribution and typical section.....	20
Figure 8 - Flotation Waterline positions	22
Figure 9 - Bulb and Winglet detection scheme.....	25
Figure 10 - Upper Bulb Shape factor examples	26
Figure 11 - Widest Point detection	27
Figure 12 - Typical Righting arm curve and hydrostatic data output	28
Figure 13 – Sail Parameters	32
Figure 14 - Basic Sail Force Coefficients	32
Figure 15 - De-powering scheme.....	33
Figure 16 - Routine for de-powering	34
Figure 17 - Roach Calculation	36
Figure 18 - Alternative Mainsail Force Coefficients	37
Figure 19 - Fractionality Coefficient	38
Figure 20 - Alternative Jib Force Coefficients.....	40
Figure 21 - Spinnaker and Code zero Coefficients	42
Figure 22 - Large Spinnaker Force Correction in light winds	43
Figure 23 - Typical Form of “Collective” Upwind Sail Force Coefficients	49
Figure 24 - Variation of Effective span factor with Apparent wind angle	51
Figure 25 - Variation of Drag Coefficient with Flat parameter	52
Figure 26 - Twist Function	54
Figure 27 - Strip wise segmentation of appendages	56
Figure 28 - Propeller Installation Dimensions	58
Figure 29 - Typical Rr multiplier at fixed Froude Number	61
Figure 30 - Flotation Planes	62
Figure 31 - Induced drag.....	63
Figure 32 - Variation of effective draft with speed and heel angle (Upper BTR = 4; Lower BTR =2)	66
Figure 33 - Principle of estimating transom immersion.....	68
Figure 34 - Appendage residuary resistance per unit volume at standard depth.....	69
Figure 35 - Wave energy as a function of True Wind Velocity.....	70
Figure 36 - Performance line scoring.....	79

List of tables

Table 1 - Mainsail force coefficients	36
Table 2 - Application of Alternative Coefficient sets for Mainsails	37
Table 3 - Genoa Force Coefficients	39
Table 4 - Application of Alternative Coefficient sets for jibs	39
Table 5 - Symmetric Spinnaker Force Coefficients	41
Table 6 - Asymmetric Spinnaker tacked on centreline Force Coefficients.....	41
Table 7 - Asymmetric Spinnaker tacked on a pole Force Coefficients.....	41

Table 8 - Code Zero force coefficients	Error! Bookmark not defined.
Table 9 - Windage force model.....	47
Table 10 - Calculated PHI_UP values	53
Table 11 - Appendage Cf. values used in the VPP	56
Table 12 - L calculation scheme.....	62
Table 13 - Added Resistance in Waves; parametric limits and base values.....	72
Table 14 - VPP True wind angle and wind speed matrix.....	75
Table 15 - Velocity prediction printed on the 1st page of the ORC International certificate	77
Table 16 - Time Allowances and Selected Courses on the 1st page of the ORC International certificate.....	77
Table 17 - Simple scoring options on ORC International & ORC Club certificate	78
Table 18 - Time allowance weighting table.....	80

1.2 Revision List

1.2.1 2012

Section	Change
3.5.1	Modified Dynamic Allowance terms
5.2.3.3	Modified force coefficients for large spinnakers in light airs.
5.4.2.1	Add Jib Twist effect on sail plan vertical centre of pressure
6.3.11	Include effect of crew longitudinal position on Immersed transom resistance.
8.2.5	Offshore Single Number Handicap added

1.2.2 2013

Section	Change
	Fig 5 Updated
	Equation 2 Revised
4.2.2	Removed
4.2.2.2	Removed
5.2.1.1	Roach Calculation.
5.2.3.2	Asymmetric on CL coefficients changed
5.2.3.3	Shape Function modified
5.2.3	Blanketing Function deleted.
5.2.5.2	Power Function Modified
6.1.1	Viscous resistance of canoe body modified
6.3	Residuary resistance Formulation Modified
6.3	Transom overhang deleted
6.3	SBF factor deleted
6.4	Heel Drag modified

1.2.3 2014

Section	Change
3.4.4	Added configuration of water ballast with canting keel
4.2.6.2	Possibility to rate boats with double fixed keel with bulb
4.4.5	RM Bias for ORC Club boats not inclined
5.2.3.5	Reduced maximum heel angle with spinnaker
5.2.4	Fine tuning of Power function
5.2.5	Headsails set flying
5.4.3.2	Cd-C12 mutliplier in the aero model
6.3.1	Fine tuning of Residuary Resistance
6.4.1	Fine tuning of canting keel with double canards
6.4.2	Reduced maximum heel angle with spinnaker
6.5.2.1	Carbon mast elastic modulus modified
6.5.2.1	Titanium and carbon stanchions allowance
8.2.5	Offshore Single Number fine tuning

**1.2.4 2015**

Section	Change
4.4.5	New formula for the rated righting moment
5.2.2.2	Blending of battened genoa and jib aero coefficients
5.2.5.2	Change of default sail area for headsail set flying
5.2.5.4	New set of aero coefficients for headsail set flying with tight luff
6.2.1	Update on folding and feathering propeller treatment
8.3	New Class Division Length (CDL) definition

2 *Introduction*

2.1 *Scope*

The following document is a companion to the ORC Rating Rules and IMS (International Measurement System). The document provides a summary of the physics and computational processes that lie behind the calculation of sailing speeds and corresponding time allowances (seconds/mile). The current ORC handicap system comprises 3 separate elements:

- 1) The IMS measurement procedure whereby the physical shape of the hull and appendages are defined, along with dimensions of mast, sails, etc.
- 2) A performance prediction procedure based on (1) a lines processing procedure which determines the parametric inputs used by the Velocity Prediction Program (VPP) to predict sailing speed on different points of sailing, in different wind speeds with different sails set.
- 3) A race management system whereby the results of (2) are applied to offer condition-specific race handicapping.

This document describes the methodology of the equations used to calculate the forces produced by the hull, appendages, and sails, and how these are combined in the VPP.

2.2 *Overview*

Predicting the speed of a sailing yacht from its physical dimensions alone is a complex task, particularly when constrained by the need to do it in the “general case” using software that is robust enough to be run routinely by rating offices throughout the world. Nevertheless this is what the ORC Rating system aims to do. The only absolute record of the VPP (and companion Lines Processing Program (LPP)) is the FORTRAN source code, so it is a difficult matter for a layman to determine either the intent or underlying methodology by inspection of this code.

The purpose of this document is to describe the physical basis of the methods used to predict the forces on a sailing yacht rig and hull, and to define the formulations (equations) used by the VPP to encapsulate the physical model.

In order to do this the document has been set out to first layout the broadest view of the process, gradually breaking the problem down into its constituent parts, so that ultimately the underlying equations of the VPP can be presented.

2.3 *Layout*

The document is arranged in 6 sections:

- **Section 3** describes the methods by which the velocity prediction is carried out and the fundamental force balances inherent in solving the problem are laid out. Following this an overview of the “boat model” is presented, whereby the elements of the aerodynamic and hydrodynamic model are described.
- **Section 4** describes how the hull shape parameters are pre-processed to determine the parameters that are used in the hydrodynamic force model described in Section 8.
- **Section 5** describes how the yacht’s environment is characterized in terms of the incident wind field experienced by the sails.
- **Section 6** describes how the VPP results are presented as a rating certificate.
- **Section 7** describes the methods used to predict the aerodynamic forces produced by the mast, sails, and above-water part of the hull.
- **Section 8** describes how the hydrodynamic drag and lift of the hull and appendages are calculated.

3 VPP Methodology

The VPP has a two-part structure comprised of the solution algorithm and the boat model. The solution algorithm must find an equilibrium condition for each point of sailing where:

- a) the driving force from the sails matches the hull and aerodynamic drag, and
- b) the heeling moment from the rig is matched by the righting moment from the hull.

i.e. balance the seesaw in *Figure 1*¹⁰, and optimize the sail controls (reef and flat) to produce the maximum speed at each true wind angle.

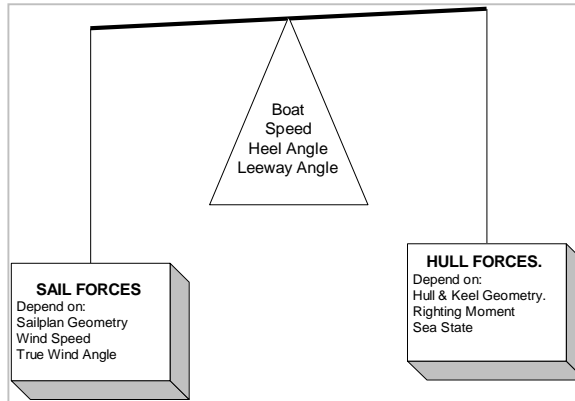

Figure 1 - Force Balance See-saw

3.1 Solution Method

The VPP determines the steady state conditions by satisfying 2 equilibrium equations:

Firstly the net force along the yacht's track (its direction of motion) must be zero,

$$(i.e. \text{Driving Force} - \text{Drag} = 0)$$

Secondly the aerodynamic heeling moment produced by the mast & sails must be equal and opposite to the righting moment produced by the hull and crew.

$$(i.e. \text{Heeling Moment} - \text{Righting Moment} = 0)$$

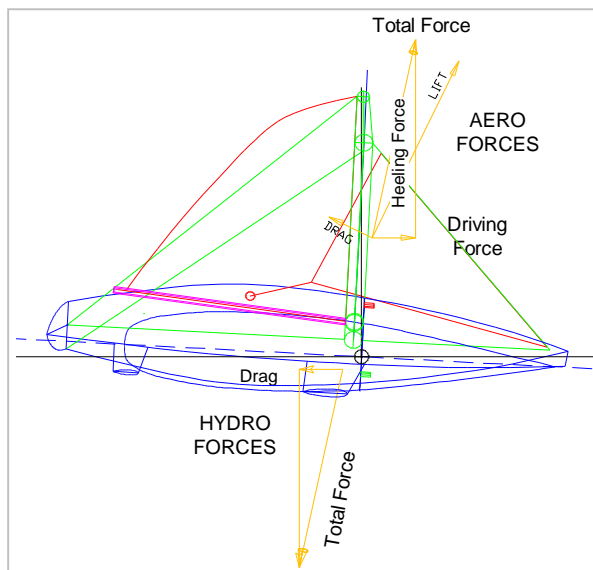

Figure 2 - Force balance in the plane of the water surface

¹⁰ Milgram 1993

Figure 2 shows a yacht sailing on starboard tack. In order for the yacht to hold a steady course the magnitude and line of action of the aerodynamic and hydrodynamic forces must be the same. The VPP adopts an iterative procedure at each true wind speed and angle to find “equilibrium” sailing conditions, defined by unique values of boat speed (V_s), heel angle (ϕ), and the sail trim parameters (reef, flat) where;

- 1) Thrust (driving force) from the sails equals the hydrodynamic drag.
- 2) The heeling moment produced by the couple between the aerodynamic and hydrodynamic Heeling Force equals the hull righting moment, as shown in Figure 3.

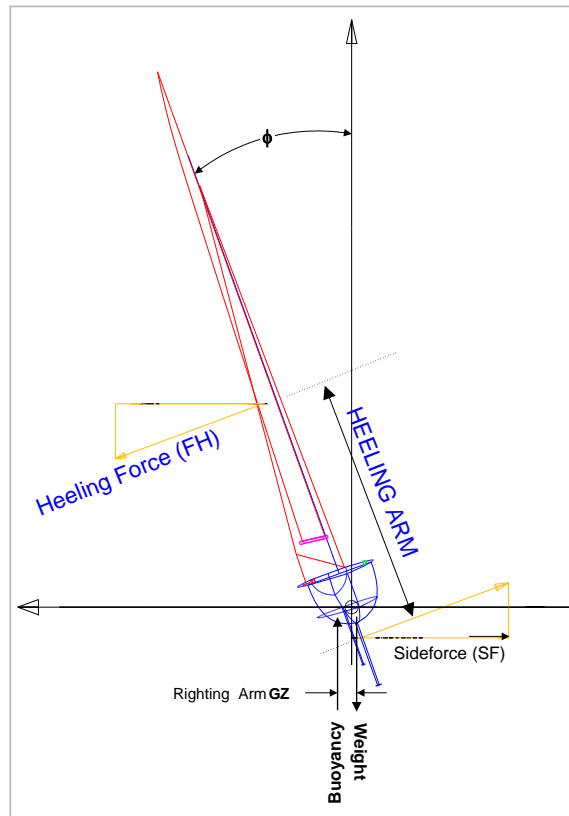

Figure 3 - Roll Moment Equilibrium

It should be noted that the VPP solves only for a balance of force and moment about the track axis. The yaw moment balance is ignored so that sail trimming options, or speed and heel values that produce excessive yaw moments, are not reflected in terms of their influence on speed.

3.2 Boat Model

The boat model may be thought of as a black box into which boat speed, heel angle, and the sail trim parameters, reef and flat are input. The output is simply four numbers:

- the aerodynamic driving force,
- the heeling moment from the above water part of the hull and rig,
- the drag of the hull keel and rudder and,
- the righting moment from the hull and crew.

The solution algorithm iterates to a solution by interrogating the boat model with each new guess of the input values until a set of conditions is found that produces a match of thrust and drag and heeling moment and righting moment. The solution algorithm also seeks to find the highest speed on each point of sailing by adjusting the sail trim parameters for optimum performance.

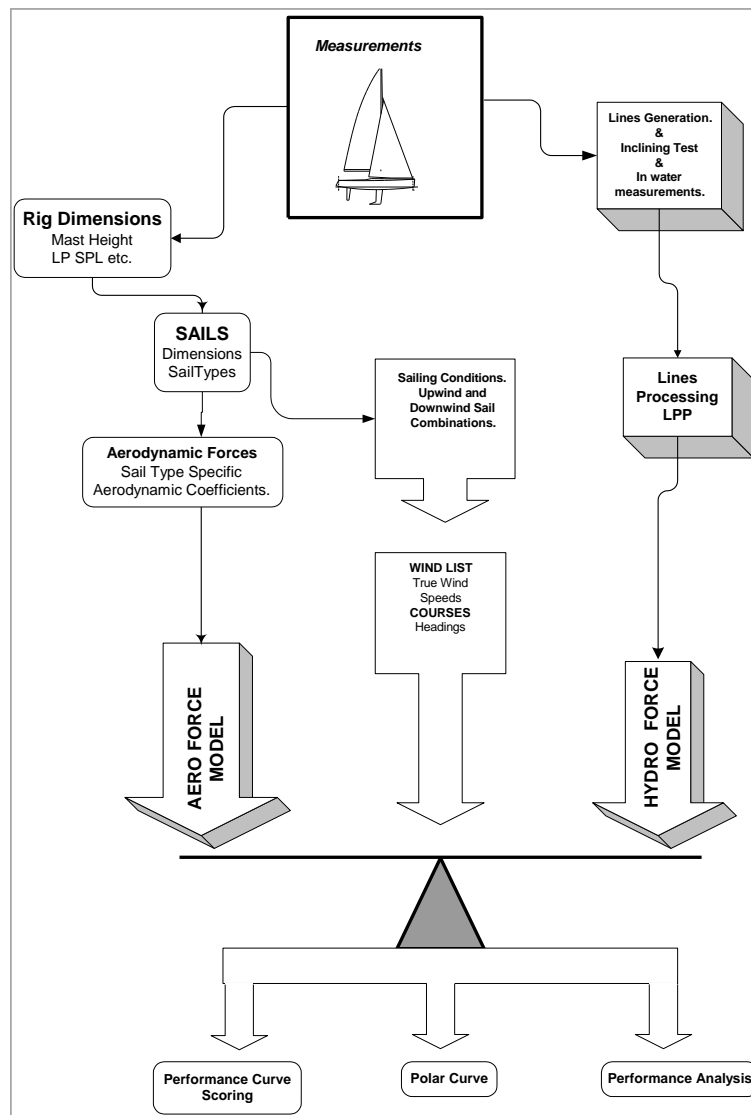

Figure 4 - Schematic of ORC VPP

Figure 4 shows how the boat model is divided into two parts:

Aerodynamic Force Model

For a given wind and boat model variable set (true wind speed V_T , true wind angle β_T , V_s , ϕ , reef, flat), determine the apparent wind angle and speed that the sails ‘see’ and predict the aerodynamic lift and drag they produce. The aerodynamic forces are resolved into a thrust and heeling force.

Hydrodynamic Force Model

Predicts the resistance (drag) and righting moment the hull produces for the assumed speed and heel angle, given that the hydrodynamic side force will equal the previously calculated aerodynamic heeling force.

3.2.1 Functional relationships

Figure 5 shows the functional relationships that make up the elements of the VPP boat model. In order to minimize amount of computational operations within the main iterative VPP loop the Rig Analysis and the Lines Processing parts are carried out before the computations of a steady state solution begin.

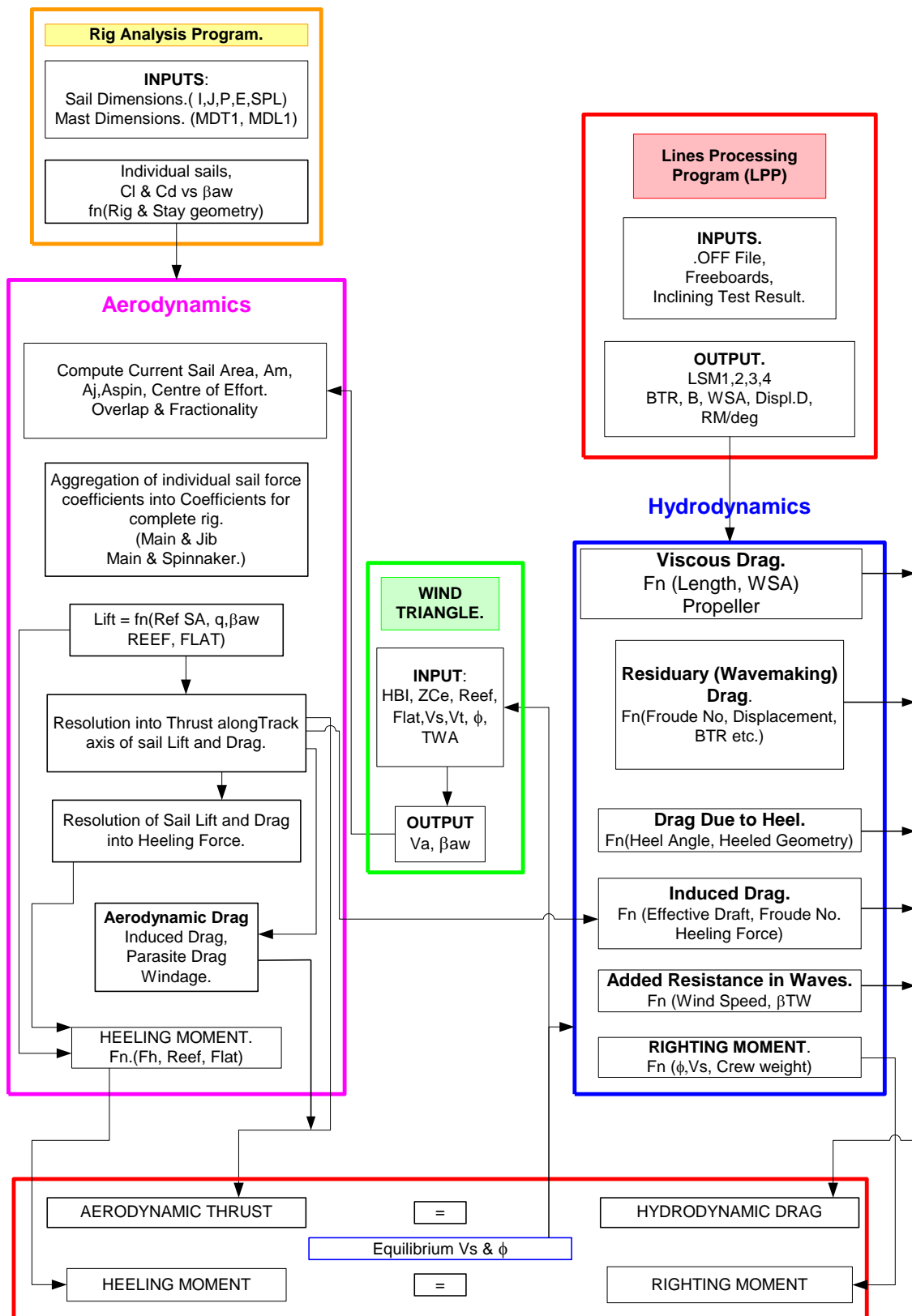

Figure 5 - Functional Relationships in the VPP Boat Model

3.2.1.1 Rig Analysis Program

The Rig Analysis Program takes the measured sail and rig dimensions and calculates the areas and centres of effort for the mainsail, jib and spinnaker. Originally the Rig Analysis Program used the force coefficients for each individual sail to calculate a “collective” set of aerodynamic force coefficients for the rig in an upwind and downwind configuration. This collective table of lift and drag coefficients at each apparent wind angle is interrogated by the solution algorithm during each iteration as the program works towards an equilibrium sailing condition.

More recently¹¹ for the upwind sailing configurations the calculation of the “collective” sail force coefficients was moved inside the VPP optimization loop so that a more realistic model of sail heeling force reduction could be used.

3.2.1.2 Lines Processing Program (LPP)

The lines Processing program takes the measured hull shape, expressed as an offset file¹², and calculates the hull dimensions and coefficients that are used to calculate hull drag. The LPP also takes the inclining test results and uses this to determine the yachts stability in sailing trim.

Once these elements have been completed the iterative part of the VPP is started. At each wind speed and true wind angle the process starts with an initial guess at speed and heel angle, given this the wind triangle can calculate the apparent wind speed and angle for the aerodynamic model.

With this information the total aerodynamic force can be calculated, based on the “collective” aerodynamic coefficients. The total aerodynamic force is resolved into the thrust and heeling force (See *Figure 2*).

Using the same initial guess for speed and heel angle, plus the calculated heeling force from the aerodynamic force model, the hydrodynamic model can calculate the total hull drag.

The available thrust and the drag can now be compared and a revised estimate of speed can be made, so the heeling moment and righting moment are compared to provide a revised value for heel angle. This process is repeated until speed and heel angle have converged to a steady value. The process is then repeated for a matrix of true wind angles and wind speeds.

The solution routine also includes an optimization element that ensures the sail trim parameters (reef and flat) are chosen to produce the highest speed on each point of sailing. The same routine is used to ensure that the VPP calculates an optimum up-wind and down-wind VMG for each true wind speed.

3.3 Equations of Equilibrium

In order to produce a steady state sailing condition the VPP must solve the 2 equilibrium equations matching available driving force to drag, and the heeling moment to the hull righting moment. The accuracy of the VPP prediction is entirely reliant on the accuracy with which these 4 elements can be calculated from parametric data gathered during the measurement process

3.3.1 Driving Force – Drag

This is the basic equation for longitudinal force equilibrium, with the net force along the boat’s track being zero:

$$FRA - FRW = 0$$

[1]

where:

FRA = Total Aerodynamic Thrust
FRW = Total Resistance

¹¹ 2009

¹² .OFF File, a simple txt file of transverse (y) and vertical (z) coordinates of the hull surface at a fixed longitudinal (x) position.

The total resistance is treated as the sum of 4 separate components, shown in *equation [2]* In reality these divisions are not physically clear-cut, but the approach is adopted to make the problem tractable using a parametric description of the hull and its appendages.

$$FRW = D_{Visous} + D_{Residuary} + D_{Induced} + D_{Raw} \quad [2]$$

where:

- D_{Visous} = Drag due to the friction of the water flowing over the surface of the hull and appendages at the current heel angle, and the propeller if one is fitted.
- $D_{Residuary}$ = Residuary Drag, drag due to the creation of surface waves, calculated from the hull parameters at the current heel angle.
- $D_{Induced}$ = Induced Drag created when the hull keel and rudder produce sideforce
- D_{Raw} = Drag due to the yachts motion in a seaway.

The aerodynamic driving force is the Aerodynamic driving force less the windage drag of the above-water boat components.

$$FRA = FRA_{b4windage} - FRA_{hull} - FRA_{mast} - FRA_{rigging} - FRA_{crew} \quad [3]$$

where:

- $FRA_{b4windage}$ = Aerodynamic driving force
- FRA_{hull} = Hull windage drag
- FRA_{mast} = Mast windage drag
- $FRA_{rigging}$ = Rigging wire drag
- FRA_{crew} = crew windage drag

3.3.2 Heeling Moment – Rolling Moment

The aerodynamic heeling moment produced by the mast and sails must be equal and opposite to the righting moment produced by the hull and crew.

$$HM_{TOTAL} = RM_{TOTAL} \quad [4]$$

$$HM_{TOTAL} = HMA + RM_4 \cdot FHA \quad [5]$$

$$HMA = HMA_{B4windage} + HMA_{hull} + HMA_{mast} + HMA_{rigging_wire} + HMA_{crew} \quad [6]$$

where:

- HM_{TOTAL} = Total heeling moment
- RM_{TOTAL} = Total righting moment
- HMA = Aerodynamic heeling moment about the waterplane
- RM_4 = Vertical CLR, below waterplane
- FHA = Total aerodynamic heeling force (equal to hydrodynamic force normal to the yachts centre plane)
- $HMA_{B4windage}$ = Aerodynamic heeling moment from sails
- HMA_{hull} = Hull windage heeling moment
- HMA_{mast} = Mast windage heeling moment
- $HMA_{rigging_wire}$ = Rigging wire heeling moment
- HMA_{crew} = Crew windage heeling moment

FHA is the total aerodynamic heeling force.

$$FHA = FHA_{B4windage} + FHA_{hull} + FHA_{mast} + FHA_{crew} \quad [7]$$

where:

$FHA_{B4windage}$	=	Aerodynamic heeling force from sails
FHA_{hull}	=	Hull windage heeling force
FHA_{mast}	=	Mast windage heeling force
$FHA_{rigging\ wire}$	=	Rigging wire heeling force
FHA_{crew}	=	Crew windage heeling force

RM_{TOTAL} is the total net righting moment available from the hull and crew sitting off centreline.

$$RM_{TOTAL} = RM\phi - RMV + RM_{aug} \quad [8]$$

where:

$RM\phi$	=	Hydrostatic Righting Moment
RMV	=	Stability loss due to forward speed
RM_{aug}	=	Righting moment augmentation due to shifting crew

3.4 *Water Ballast and Canting Keel Yachts*

The following section describes the VPP run sequences for yachts with moveable ballast and retractable dagger boards or bilgeboards.

3.4.1 *Canting Keel*

Two VPP runs are made and the best speed achieved on each point of sailing is used to calculate the handicap.

- First VPP run with canting keel on Centre Line (CL) without adding any Righting Moment increase (MHSD computed with the keel on CL)
- Second VPP run with canting keel fully canted adding Righting Moment increase (MHSD computed from the maximum of the two rudders and canted keel.)

3.4.2 *Daggerboard (Centreline lifting appendage)*

The daggerboard is input to the .DAT file with a special code to identify it as such. Two VPP runs are made and the best speed achieved on each point of sailing is used to calculate the handicap.

- First VPP with the dagger board up. If the yacht has a canting keel this VPP run is done with the keel on centre line.
- Second VPP run with the dagger board down, viscous drag calculated as if it were a conventional fin keel. If the yacht has a canting keel this run is done with the keel at full cant angle. (MHSD is computed with maximum depth based on the keel canted, dagger board down and aft rudder)

3.4.3 *Bilge boards (lifting boards off centreline)*

Bilge boards are added to the .DAT file with special code for bilge board (angle and lateral position input also). Two VPP runs are made and the best speed achieved on each point of sailing is used to calculate the handicap.

- First VPP run with the bilge board up. If the yacht has a canting keel this VPP run is done with the keel on centre line.
- Second VPP run with the leeward bilge board down, viscous drag calculated as if it were a conventional fin keel. If the yacht has a canting keel this run is done with the keel at full cant angle. (MHSD computed with maximum depth between keel canted, fwd leeward bilge board down and aft rudder)

3.4.4 Water ballast

Two VPP runs are executed, with and without water ballast; the fastest speed is used for handicapping. When water ballast volume is input directly, the following values are assumed:

$$\begin{aligned}\text{Water ballast VCG} &= 0.50 \times \text{freeboard_aft} \\ \text{Water ballast LCG} &= 0.70 \times \text{LOA} \\ \text{Water ballast Moment arm} &= 0.90 \times \text{crew_arm}\end{aligned}$$

When there are water ballast tanks (one tank on each side) and canting keel, the following runs are performed:

- a) tanks empty, keel on CL
- b) tanks empty, keel to windward
- c) tank to windward filled, keel on CL
- d) tank to windward filled, keel to windward

The fastest solution among the above four is taken as the final solution.

3.4.5 Measurement

Dimensions and locations of dagger boards, bilge boards, forward rudders, etc. can now be added to the .DAT files rather than by direct measurement of their offsets with the wand or laser scanner. For water ballast yachts the volume and location of the water ballast may be edited into the .DAT file instead of by direct measurement.

3.5 Dynamic Allowance (DA)

Dynamic Allowance is an adjustment which may be applied to velocity predictions (i.e., time allowances) to account for relative performance degradation in unsteady states (e.g., while tacking) not otherwise accounted for in the VPP performance prediction model. DA is a percentage credit calculated on the basis of six design variables deemed to be relevant in assessing the performance degradation and is applied (or not applied) as explained below.

Even where applied, the result of the calculated credit may be zero. The design variables considered are described in section 3.5.1 below. Where applied, the calculated amount of credit will vary with point of sail and wind velocity.

These credits are therefore applied individually to each respective time allowance cell in the large table on the Rating Certificate (see *Table 15*) entitled, "Time Allowances." The credit is also automatically carried forward into the "Selected Courses" time allowances table, because these course time allowances are comprised of the appropriate proportions of various time allowances from the larger table. Likewise, any credit is carried forward into the General Purpose Handicap (GPH) and the "Simplified Scoring Options." The single value for DA which is actually displayed on the Certificate is that which was applied to GPH and is shown only to give a comparative reference to the average DA applied for the yacht.

For yachts of Cruiser/Racer Division which comply with IMS Appendix 1, the DA percentage credits are always fully applied to the time allowances. For other yachts, no DA is applied for the first three years of age (as defined in 2 below). Thereafter, DA is applied incrementally with only 20% of the full calculated DA being applied in the fourth year and a further 20% in each of the following years until full DA is applied in the eighth year. The various credits are derived from a statistical study of a fleet of Cruiser/Racers and Racers, based on IMS L to take into account a scaling factor. For each parametric ratio, an area in the Cartesian plane (Ratio/L) is fixed, limited by two boundary lines which represent a statistical approximation of the Cruiser/Racers and the Racers respectively. For a given "L", a difference is calculated as the distance between the boundary limits. The individual contribution of each parameter for the given yacht will be the ratio of the distance between the individual yacht's parameters relative to the Racer boundary line and the previously computed distance between the boundaries, with a cap value for each of the parameters.

3.5.1 Credits (2012)

The credits are then calculated as follows:

$$Credit = MaxCredit \cdot \frac{racer_slope \cdot L + racer_incpt - RATIO}{(racer_slope - cruiser_slope) \cdot L + (racer_incpt - cruiser_incpt)} \quad [9]$$

where:

<i>RATIO</i>	<i>racer_slope</i>	<i>racer_incpt</i>	<i>cruiser_slope</i>	<i>Cruiser_incpt</i>	<i>MAXIMUM CREDIT</i>
<i>btgsa/vol</i>	0.62	19.0	0.392	15.238	0.75%
<i>runsa/vol</i>	1.00	32.00	0.727	25.093	0.30%
<i>btgsa/ws</i>	0.058	2.39	0.0294	2.38	0.75%
<i>runsa/ws</i>	0.089	4.10	0.059	3.924	0.30%
<i>L/vol</i>	0.062	4.450	0.055	3.985	0.30%

3.5.1.1 Beating credit

Applied full strength to VMG Upwind, then linearly decreased to zero at 70° True Wind Angle (TWA), varied with True Wind Speed (TWS) as follows:

$$Beating_Credit = \frac{btgsa \cdot (20 - TWS)}{Wetted_Area_Credit \cdot (20 - 6)} + \frac{BSA \cdot TWS}{Volume_Credit \cdot 20} \quad [10]$$

btgsa/Wetted Area Credit is calculated with complete Sail Area (mainsail + genoa), BSA/ Volume Credit is calculated with Sail Area = Mainsail + foretriangle

3.5.1.2 Running credit

Applied full strength VMG Downwind, then linearly decreased to zero at 90° TWA, varied with TWS as follows:

$$Running_Credit = \frac{runsa \cdot (20 - TWS)}{Wetted_Area_Credit \cdot (20 - 6)} \cdot \frac{DSA \cdot TWS}{Volume_Credit \cdot 20} \quad [11]$$

3.5.1.3 Length/Volume ratio

Applied full strength to all TWA and TWS

3.5.2 Calculation Procedure

- 1) Compute the table of polar speeds and GPH without any credit (like all racing boats)
- 2) Compute DA credits for each true wind speed and wind angle to obtain a matrix with the same row and columns as the table of speeds.
- 3) Divide any polar speed of the table by corresponding computed credit and re-calculate the new GPH. To compute the DA value (that is printed on certificate only as reference) the ratio between new and the original GPH is used.

The typical distribution of DA over True wind speed and angle is shown in *Figure 6*.

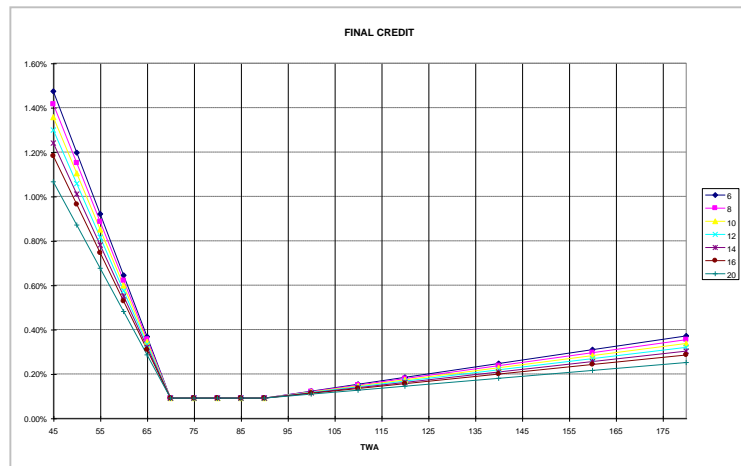

Figure 6 - DA Credit vs. True wind angle

4 Lines Processing Program

The LPP is a companion program to the VPP which processes the measurements taken from the hull and appendages into an Offset (.OFF) file and uses this point by point geometric definition to calculate integrated physical quantities that the boat model can use to perform its calculations.

The LPP uses the hull shape defined by the offset file and the results of the inclining test to determine the righting moment at each heel angle.

The LPP uses a definition of hull and appendage shape derived from physical measurement of the hull. The measurement of the hull (wanding) is carried out at pre-determined transverse stations according to the measurement instructions. A typical offset file is shown in *Figure 7*. The format of the .OFF file is described in Appendix A.

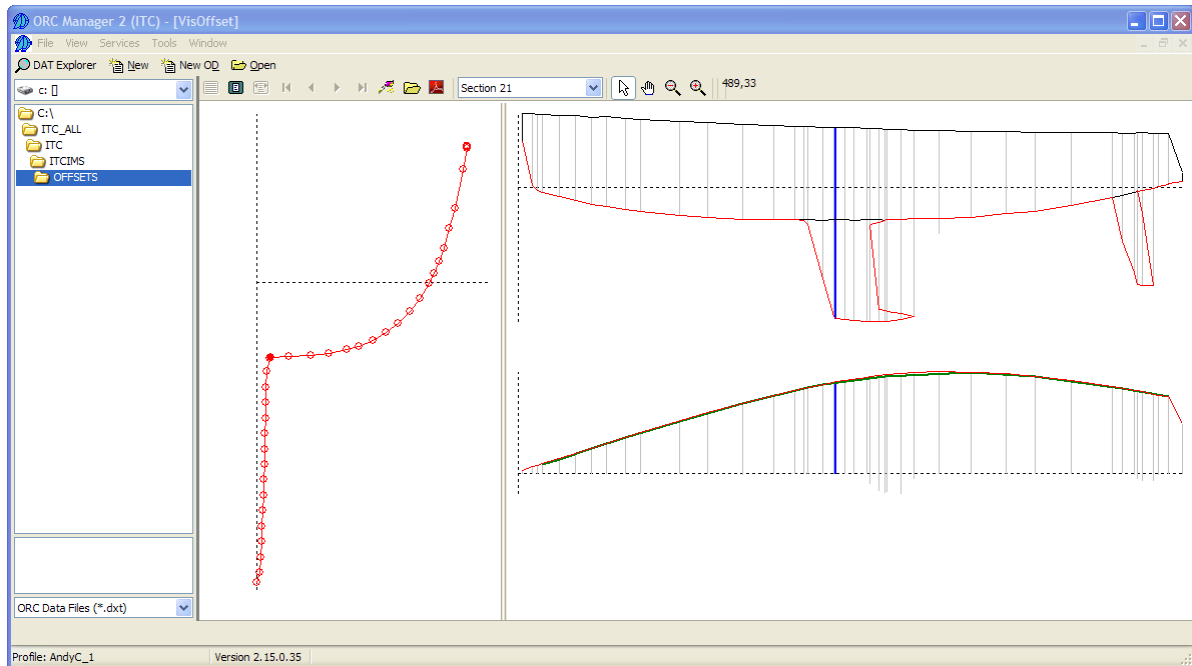

Figure 7 - Offset file station distribution and typical section

4.1 Hydrostatics

As part of the afloat measurements an inclining test is carried out and the freeboards in “Light Ship Trim¹³” are determined. The first task of the LPP is calculate a righting moment vs. heel angle curve for the yacht in its sailing condition. The following steps are carried out:

- Determine measurement trim displacement from the immersed volume of hull and appendages below the flotation waterline, using the offset file as a definition of the immersed hull and appendages
- Use the inclining test results to determine the vertical centre of gravity position (VCG) in measurement trim
- Calculate the displacement and VCG in sailing trim by the addition of weights for crew and gear
- Calculate a righting moment at specified heel angles
- Calculate the Limit of Positive Stability (LPS), the heel angle above which the yacht will capsize

4.2 LPP Output parameter definitions

In addition to the traditional “hydrostatic” calculations the LPP also calculates a number of parameters that are used by the hydrodynamic force model. Two fundamental flotation conditions are determined:

4.2.1 Measurement Trim

The floatation waterplane is that determined by the measured freeboards with the yacht floating upright. LSM0 is calculated in this condition using *equation [15]*, and an exponent “nl”= 0.25

4.2.2 Sailing Trim

To achieve sailing trim the default crew weight and gear weight are combined and added to the yacht 0.1 LSM0 aft of the Longitudinal Centre of buoyancy and $(0.5 * LSM0 + 0.36)$ m. above the measurement trim floatation plane. LSM1 is calculated in this condition using *equation [Error! eference source not found.]*, and an exponent “nl”= 0.25

4.2.2.1 Crew Weight

The default value for the Crew Weight (kg.) is calculated as follows:

$$CW = 25.8 \cdot LSM0^{1.4262} \quad [12]$$

The owner may accept the default calculated weight, but can declare any crew weight which shall be recorded in the certificate. The declared crew weight is used to compute increased righting moment while default crew weight will be used to compute sailing trim displacement.

The longitudinal position of the combined crew longitudinal centre of gravity is calculated from the formula:

$$X_loc_of_crew_cg = 0.1 \cdot LSM0_aft_LCB \quad [13]$$

4.2.2.2 Gear Weight

Gear weight is calculated from equation below:

$$Gear_Weight = 0.16 \cdot Crew_Weight \quad [14]$$

4.2.3 Second Moment Length (LSM)

$$LSM = 3.932 \cdot \sqrt{\left(\frac{\int x^2 s dx^{nl}}{\int s dx^{nl}} \right) - \left(\frac{\int x s dx^{nl}}{\int s dx^{nl}} \right)^2} \quad [15]$$

Where:

- s = an element of sectional area attenuated for depth
- x = length in the fore and aft direction
- nl = Length Exponent

This method of deriving the Effective sailing length from a weighted sectional area curve is a legacy of the original MHS system. Originally the length calculation took note of the longitudinal volume distribution of the hull, rather than include directly in the residuary resistance calculation terms that were calculated from the sectional area curve.

The depth attenuation of sectional areas is performed by multiplying each Z (vertical offset) by $e^{(-10 * Z / LSM0)}$.

The LPP uses the physical shape of the canoe body, as defined by the .OFF offset file, to calculate immersed lengths at several different waterplane positions.

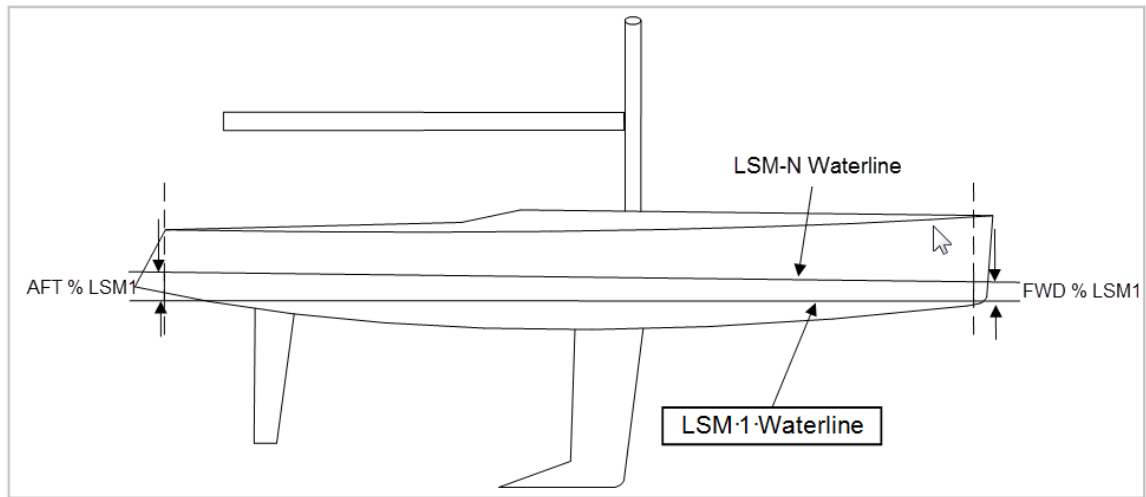

Figure 8 - Flotation Waterline positions

4.2.4 Appendage stripping

Once the offset file has been acquired and checked, the LPP “strips” off the appendages to leave a “fair” canoe body. Various hydrostatic characteristics and physical parameters are calculated using the flotation waterline determined at the in-water measurement. The characteristics of the appendages are handled separately to determine the parameters that affect their resistance.

4.2.5 Beam Depth Ratio (BTR)

The LPP also computes the effective beam and draft of the yacht's canoe body, along with the maximum effective draft of the keel. The Beam Depth Ratio (BTR) is the effective beam (B) divided by the effective hull depth (T).

$$BTR = \frac{B}{T} \tag{16}$$

4.2.5.1 The Effective Beam (B)

The effective beam is calculated based on the transverse second moment of the immersed volume attenuated with depth for the yacht in Sailing Trim floating upright. This approach “weights” more heavily elements of hull volume close to the water surface.

$$B = 3.45 \cdot \sqrt{\frac{2/3 \cdot \iint (b^3 e^{-10z/LSM0}) dz dx}{\iint (b e^{-10z/LSM0}) dz dx}} \tag{17}$$

where

- b = an element of beam;
- e = is the Naperian base, 2.7183
- z = is depth in the vertical direction
- x = length in the fore and aft direction

4.2.5.2 Effective Hull Depth (T)

The Effective Hull Depth is a depth-related quantity for the largest immersed section of the hull. It is derived from the area of the largest immersed section attenuated with depth for the yacht in Sailing Trim floating upright (AMS2) divided by B:

$$T = 2.07 \cdot \frac{AMS2}{B} \quad [18]$$

4.2.5.3 Maximum Section Areas

Maximum section areas used for the derivation of Effective Hull Depth (T).

AMS1 is the area of the largest immersed section for the yacht in Sailing Trim floating upright. AMS2 is the area of the largest immersed section attenuated with depth for the yacht in Sailing Trim floating upright.

Formulae for Maximum Section Areas, (where b is an element of beam; e is the Naperian base, 2.7183; and z is depth in the vertical direction):

$$\begin{aligned} AMS1 &= \text{maximum of } \int b \, dz \text{ over length} \\ AMS2 &= \text{maximum of } \int b \cdot e^{(-10 \cdot z / LSM0)} \, dz \text{ over length} \end{aligned}$$

4.2.6 Maximum Effective Draft (MHSD)

To inform the calculation of hydrodynamic induced drag (drag due to lift¹⁴) during the VPP force balance calculations the “effective draft” of the hull and keel combination must be calculated.

The value of the effective draft (MHSD) is determined by the LPP using the original expression for a “reduced draft” (TR) which is calculated based on the local section maximum draft and hull cross sectional area. This expression which treats the hull and keel as one half of a slender axi-symmetric body, calculates the effect of streamline contraction around the canoe body. In this way the influence of a deep hull on effective draft is accounted for.

The maximum effective draft of the keel is found by calculating the following parameters at each immersed station along the length of the hull.

$$\begin{aligned} TRMAX = xxy1 &= \text{Maximum reduced draft.} \\ TRD = xxy &= \text{Centreline immersed depth} \\ TRSA &= \text{sectional area.} \\ TRX &= \text{longitudinal location of station} \\ S(i) &= \text{the sectional area at station } i \\ Xxy &= \text{centerline immersed depth of station } (i) \end{aligned}$$

$$xxb = \sqrt{\frac{4 \cdot S(i)}{\pi \cdot BTR}} \quad [19]$$

$$xxr1 = 0.5 \cdot \left(\frac{xxy}{xxb} + \sqrt{\left(\frac{xxy}{xxb} \right)^2 + 0.25 \cdot BTR^2 - 1} \right) \quad [20]$$

$$xxr2 = \sqrt{xxr1^2 - 0.5 \cdot (1 + 0.5 \cdot BTR)} \quad [21]$$

$$xxy = xxb \cdot \left(xxr2 - \frac{0.25 \cdot (0.25 \cdot BTR^2 - 1)}{xxr2} \right) \quad [22]$$

These computed quantities are only important as intermediate results. The information is stored for the station yielding the greatest value of xxy1, “MHSD” (MHS draft), and is determined from:

$$MHSD = 0.92 \cdot \max(xxy1) \quad [23]$$

¹⁴ Described in section 8.4.3

4.2.6.1 Centreboards

Centreboards, drop keels, dagger boards etc. are treated in a similar manner. In the calculation of xxb $S(i)$ is taken as the cross sectional area for the section at the same longitudinal position as the point of maximum draft for the appendage. Also xyy is now taken as the corrected draft for the hull with the fixed keel plus the corrected centerboard extension (ECE).

$$xxb = \sqrt{\frac{4 \cdot S_{(\max \text{ depth})}}{\pi \cdot BTR}} \quad [24]$$

$$DEF = DHK_{\text{Effective}} + ECE \quad [25]$$

$$xxr1 = 0.5 \cdot \left(\frac{DEF}{xxb} + \sqrt{\left(\frac{DEF}{xxb} \right)^2 + 0.25 \cdot BTR^2 - 1} \right) \quad [26]$$

$$xxr2 = \sqrt{xxr1^2 - 0.5 \cdot (1 + 0.5 \cdot BTR)} \quad [27]$$

$$xyy1 = xxb \cdot \left(xxr2 - \frac{0.25 \cdot (0.25 \cdot BTR^2 - 1)}{xxr2} \right) \quad [28]$$

MHSD is again calculated from the formula.

$$MHSD = \max\left(0.92 \cdot xyy1, MHSD_{\text{Nocenterboard}}\right) \quad [29]$$

4.2.6.2 Twin (Double) Keels and Bulbs¹⁵

The twin keel is defined by the following inputs:

- keel distance from bow
- vertical span
- mean chord lengths and thicknesses
- y-offset (distance from CL of fin)
- angle of fin to vertical

The viscous drag is calculated using the method described in Section 6.1.2, with the exception that the keels are not divided into horizontal stripes for the purpose of calculating the local section characteristics. The induced drag is calculated using the standard method described in section 4.2.4

The bulb is defined by the following inputs:

- Length
- max width
- max height

With these data the following bulb parameters are computed, which are then used to calculate the frictional and residuary resistance with the usual schemes (6.1.2 and 6.4.1.4):

$$\begin{aligned} \text{thickness_chord_ratio} &= \text{width/length} \\ \text{wetted_area} &= 1.10 * (\text{width+height})*\text{length} \\ \text{volume} &= 0.5*\text{width}*height*\text{length} \end{aligned}$$

4.2.7 Bulb/Wing Effects

The geometry of the keel tip is influential on the induced drag of the keel fin. These effects may be both positive and negative,

- A ballast bulb with circular (or elliptical) cross section reduces the effect span of the keel fin.
- A well designed wing keel extends the effective span of the keel.

The VPP contains an algorithm which detects the type and degree of “bulb” keel or “wing” keel and modifies the effective span, derived according to section 4.3.4.

4.2.7.1 Definitions

DHK0	geometric overall draft of keel
MAXW	max width of keel
TMAXW	draft at max width of keel
	<i>MAXW and TMAXW are corrected by “10° line test”</i>
FLAGBULB	1 if bulb is detected
FLAGWING	1 if winglets are detected
UPBULBF	upper shape factor for bulb
DeltaD	effective draft correction due to bulb and/or winglet.

4.2.7.2 Winglet detection

Winglets exist if a line from the maximum width location to a point located in a vertical plane of symmetry, in the same transverse section, vertically distant from the maximum width location less than MAXW/4 which does not lie somewhere in keel (Figure 9-1). Then WWING: width is added by the wing.

4.2.7.3 Bulb detection

If winglets are not detected, a bulb exists if a line from the maximum width location to a point located in vertical plane of symmetry, in the same transverse section, vertically distant from max width location less than MAXW which does not lie somewhere in keel (Figure 9-2). Then WBULB is width added by bulb.

4.2.7.4 Bulb + Winglet detection

In any case: $MAXW = WBULB + WWING$ (Figure 9-3)

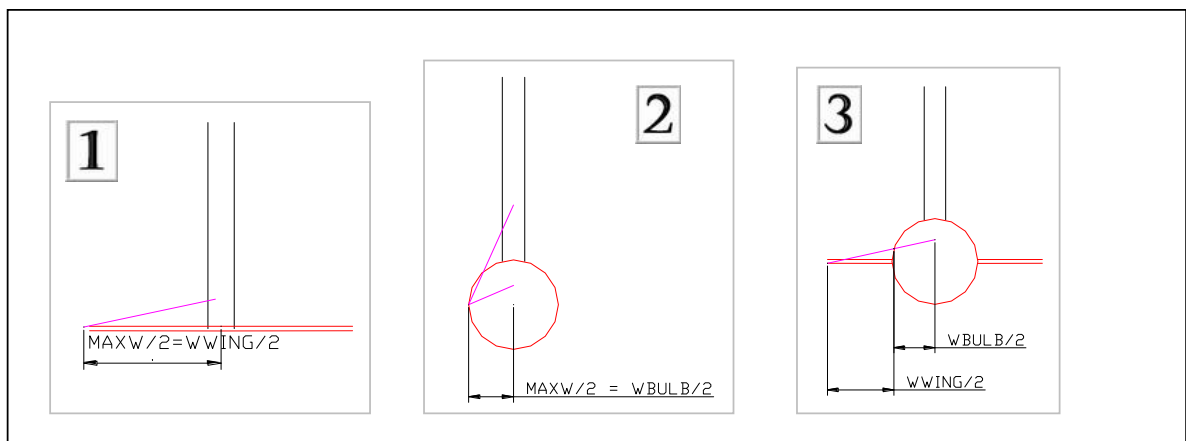

Figure 9 - Bulb and Winglet detection scheme

4.2.7.5 DeltaD formulas

DeltaD is calculated with the following formulae and then corrected by the “limitations” defined below. The formulations are based on CFD calculations for eight bulb or winglet configurations. The multiplier of 0.5 applied to f2 is an arbitrary reduction of the bulb credit.

$$\frac{\Delta D}{MHS D} = \frac{D_{HK0} - T_{MAXW}}{0.5 \cdot MAXW} \cdot \left(Flagbulb \cdot UPBULBF \cdot 0.5 \cdot f2\left(\frac{WBULB}{D_{HK0}}\right) \cdot \frac{WBULB}{Flagwing \cdot WWING + WBULB} \cdot Flagwing \cdot f3\left(\frac{MAXW}{D_{HK0}}\right) \right) \quad [30]$$

Note that:

- f2 addresses the bulb effect if there is no winglet
- f3 addresses winglet effect if there is no bulb
- in the case where bulb and winglet exist the interactions are taken into account by multiplying f2 value by the $WBULB/(Flagwing \cdot WWING + WBULB)$ term

where:

$$f1(X) = \begin{cases} \text{if } X < 1 & 1 + k1 \cdot X \\ \text{if } X > 1 & 1 + k1 \end{cases}$$

$$f2(X) = \begin{cases} \text{if } X > wbu_T0 & k2_0 + k2_1 \cdot (X - wbu_T0) \\ \text{if } X \leq wbu_T0 & k2_0 \cdot X / wbu_T0 \end{cases}$$

$$f3(X) = \begin{cases} \text{if } X < wwi_T0 & k3_0 \cdot X / wwi_T0 \\ \text{if } X \geq wwi_T0 & k3_0 + k3_1 \cdot (X - wwi_T0) \end{cases}$$

k1	0.6
k2_0	-0.06
k2_1	0.19
k3_0	0.05
k3_1	0.02
wbu_T0	0.15
wwi_T0	0.5

4.2.7.6 Upper shape factor for bulb

UPBULBF is introduced to take into account that end effect of the bulb depends of the shape of the top of the bulb. A straight shape (e.g. a Scheel Keel) has a positive effect, although a round shape has negative effect on effective draft.

Moreover UPBULBF helps to smooth the jump of DeltaD when a bulb becomes winglet. UPBULBF is defined as follows:

- Consider the rectangle defined by opposite corners at the maximum width bulb point and a point on the top surface of the bulb located at $0.05 \cdot D_{HK0}$ off the centerline. Calculate the area A_r
- Consider the enclosed part of the bulb in the rectangle. Calculate the area A_{bu}
- Define the upper bulb shape factor $UPBULBF = f4(A_{bu}/A_r)$: $f4(1) = 1$ for $x = 0.825$, $f4(0.3) = 0.3$, $f4$ linear function.
- In the bulb wing formula, multiply f2 by UPBULB.

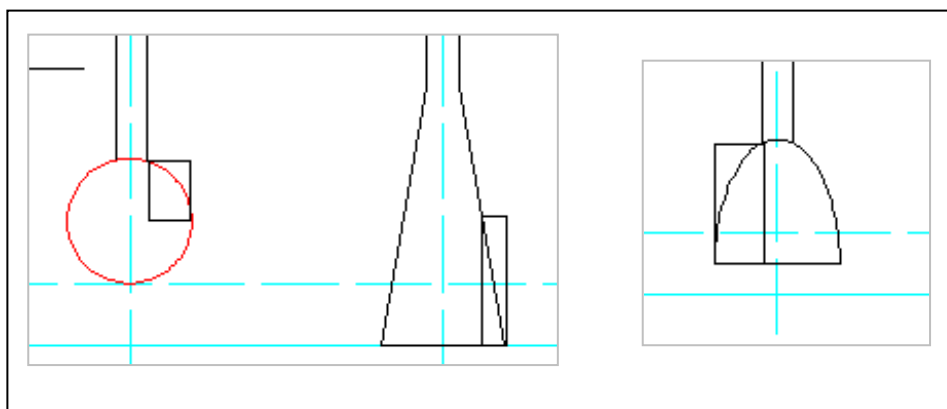

Figure 10 - Upper Bulb Shape factor examples

4.2.7.7 Limitations

$\Delta D > -0.025 * D_{HK0}$ (credit bulb limitation)

If the widest point of the bulb or winglet is not enough deep with respect to D_{HK0} and $MAXW$, the bulb or winglet are considered to have no effect:

$\Delta D = 0$ if $T_{MAXW} + 3 * MAXW/2 < D_{HK0}$

ΔD is not affected if $T_{MAXW} + MAXW/2 > D_{HK0}$

ΔD varies linearly between those two situations.

4.2.7.8 Smoothing technique

Because the detection scheme must work on old offset files, which may sparse data points in the area of the keel tip, it is important to avoid catching spurious “widest points”. When, going down along the bulb/winglet section, you find the point of max width, at that point the “10 deg line test” is applied.

The test is to trace an almost vertical line downward, inclined 10 degrees inboard. The lowest offset point that lies “external” to that line is taken as the widest point of the section, in way of the actual widest point. At this point the test is applied for winglet and bulb (see *Figure 11*).

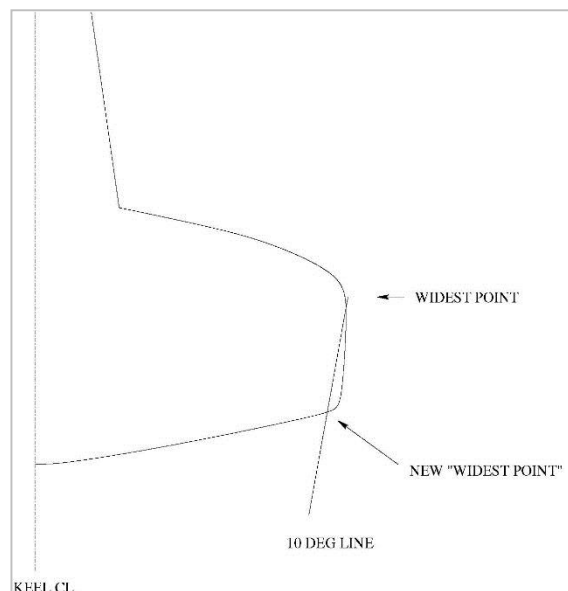

Figure 11 - Widest Point detection

4.3 Appendage wetted areas and lengths

The original VPP formulations were concerned only with “conventional” fin keel and rudder configurations. Subsequently the ability to handle off centre appendages, and canting keels has been added.

4.3.1 Conventional Fin keel and rudder

The keel and rudder are divided into 5 horizontal strips and a wetted surface area together with a mean length and thickness to chord ratio is calculated for each strip. These values are used to calculate the viscous resistance of the appendages. In this case the volume of the fin keel and any associated bulb is calculated so that the contribution to wave making resistance may be calculated.

4.3.2 Other appendages

The LPP can deal with twin rudders, centreboards, forward rudders, fixed or retractable dagger boards. These appendages can be added into the .DAT file based on their measured dimensions, rather than

including them in the wanded .OFF file data. Only the viscous drag of these appendages is calculated, based on methods described in detail in section 8.1.2. The LPP also calculates any reduction of wetted surface area that occurs if any dagger board, twin rudder etc. comes above the flotation waterline.

4.4 Righting Moment

4.4.1 Righting Arm Curve

The LPP calculates a righting arm against heel angle curve (*Figure 12*).

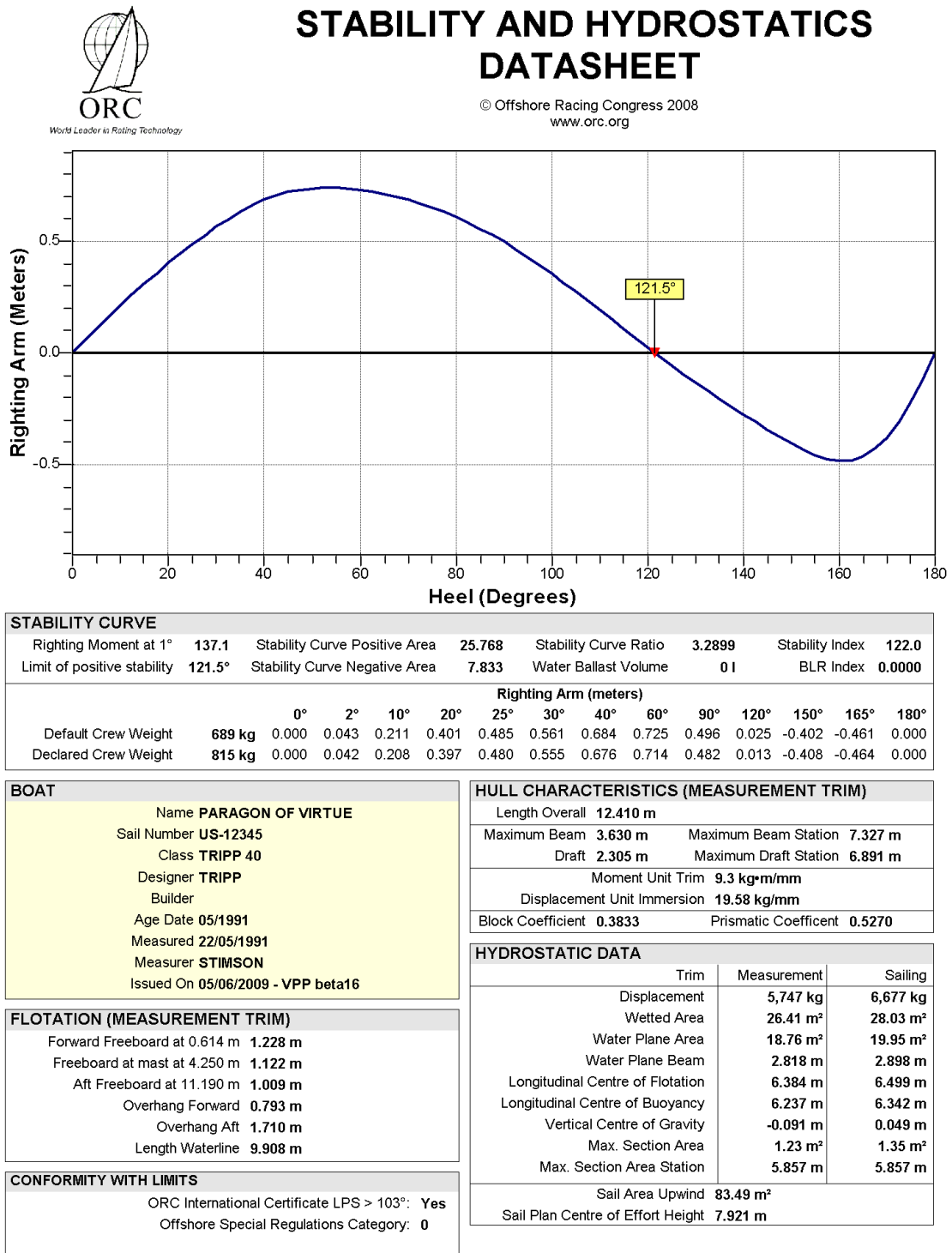

Figure 12 - Typical Righting arm curve and hydrostatic data output

4.4.2 Hydrodynamic Centre of Pressure

The hydrodynamic vertical center of pressure RM4 is given by:

$$RM\ 4 = 0.43 \cdot T_{\max} \quad [31]$$

4.4.3 Crew righting moment

The crew righting moment is based on the declared crew weight or a default crew weight calculated from $CW = 25.8 \cdot LSM^{1.4262}$. The assumed individual crew weight is 89 kg and the number of crew is calculated by dividing the crew weight by this value.

Two less than the total number of crew are distributed along the deck edge of the boat centered about the assumed centre of gravity position, a single crew member is assumed to occupy a width of 0.53m.

The lever arm of the crew on the rail is the average hull beam over the length of side deck occupied by the crew. The remaining 2 crew members, the helmsman and main trimmer are assumed to have transverse centre's of gravity at 70% of the yachts maximum half beam.

4.4.3.1 LSM greater than 4.9m (16 feet)

For yachts with LSM greater than 4.9 m the crew weight on the rail is 2 less than the total crew, the remaining 2 are assumed to sit slightly inboard:

$$Crew \cdot rightingarm = \left(CARM \cdot CREWRW + 0.7 \cdot 2 \cdot \frac{B_{\max}}{2} \cdot bodywt \right) \cdot \cos(heel) \quad [32]$$

where:

CARM	=	Crew righting arm
CREWRW	=	Crew weight on the rail
Bmax	=	Hull maximum
bodywt	=	Average crew body weight.
heel	=	Heel angle

4.4.3.2 LSM less than 4.9m

For yachts with LSM less than 4.9 m the crew weight is all sat on the rail.

$$Crew \cdot rightingarm = (CARM \cdot CREWRW) \cdot \cos(heel) \quad [33]$$

4.4.3.3 Crew weight transverse position

Sailing with the upwind sails the crew righting moment is only applied in full once the heel angle exceeds 6 degrees.

When using the downwind sails (i.e. not a jib), the crew position is set with everyone to leeward up to a heel=10 deg., then it sinusoidally changes from leeward to neutral from 10 to 14 degrees of heel, and then sinusoidally moves all the crew to windward from 14 to 18 degrees of heel¹⁶.

4.4.4 Dynamic Righting Moment. RMV

RMV is a term intended to account for the difference between the hydrostatic righting moment calculated by the LPP, and the actual righting moment produced by the hull when moving through the water. This term was in the VPP from its first implementation¹⁷.

$$RMV = \frac{5.955 \cdot 10^{-5}}{3} \cdot DSPL \cdot LSM \cdot \left(1 - 6.25 \frac{B_{cb}}{\sqrt{AMS1_{cb}}} - 2.1 \right) \cdot SLR \cdot \phi \quad [34]$$

¹⁶ 2011

¹⁷ The divisor of 3 in the first term was introduced in 2000 to correct an over-prediction of RMV for contemporary hull forms.

where

DSPL	=	Displacement
B _{cb}	=	Canoe body beam
AMS1 _{cb}	=	Maximum section area of canoe body
SLR	=	Speed length ratio

4.4.4.1 Dynamic Stability System (DSS)

The DSS is the deployment of an approximately horizontal hydrofoil on the leeward side of the yacht that generates a vertical force component to augment the yachts righting moment. For 2010 the VPP will be able to calculate the drag and increased righting moment available from a DSS. The data input file take in the geometrical data of the foil's size and position and use a simple algorithm to calculate the increased righting moment of the foil. The lift force is proportional to the square of the yachts speed, and the maximum extra righting moment capped at a percentage of the yachts typical sailing righting moment. Like all features of the IMS VPP this force prediction algorithm is intended to provide an equitable handicap for yachts fitted with the DSS. It is not a "design and optimization" tool.

4.4.5 Rated Righting Moment

The rated righting moment used in the VPP calculations is the average between the measured and default RM as follows:

$$RM_{rated} = \frac{2}{3} \cdot RM_{measured} + \frac{1}{3} \cdot RM_{default} \quad [35]$$

Default righting moment is calculated as follows¹⁸:

$$RM_{default} = 1.025 \cdot \left(a_0 + a_1 \cdot BTR + a_2 \cdot \frac{\sqrt{VOL}}{IMSL} + a_3 \cdot \frac{SA \cdot HA}{B^3} + a_4 \cdot \frac{B}{\sqrt[3]{VOL}} \right) \cdot DSPM \cdot IMSL \quad [36]$$

where all the variables are calculated by the VPP using the following coefficient values.

a0	=	-0.00410481856369339 (regression coefficient)
a1	=	-0.0000399900056441 (regression coefficient)
a2	=	-0.0001700878169134 (regression coefficient)
a3	=	0.00001918314177143 (regression coefficient)
a4	=	0.00360273975568493 (regression coefficient)
DSPM	=	displacement in measurement trim
SA	=	sail area upwind
HA	=	heeling arm, defined as (CEH main*AREA main + CEH headsail*AREA headsail) / SA + HBI + DHKA*0.45, for mizzen (CEH headsail*AREA headsail + CEH mizzen*AREA mizzen) is added to the numerator
CEH	=	height of centre of effort
DHKA	=	Draft of keel and hull adjusted

Default righting moment shall not be taken greater than 1.3*RM_{measured} nor smaller than 0.7*RM_{measured}.

For movable ballast boats the default righting moment intends to predict the righting moment of the boat without the effect of movable ballast (water tanks empty, or keel on the center plane), is then decreased by a factor (1- RM@25_movable/RM@25_tot), where RM@25_movable is the righting moment due to the contribution of movable ballast at 25 degrees of heel, and RM@25_tot is the total righting moment at 25 degrees, with keel canted or windward tanks full. For these boats, the max and min bounds are set to 1.0 x RM_{measured} and 0.9 x RM_{measured} respectively.

If righting moment is not measured or obtained from another source, the rated righting moment shall be increased for 3% and shall not be taken less than one giving the Limit of positive stability (LPS) of 103.0 degrees or 90.0 degrees for an ORC Sportboat.

¹⁸ 1.025 multiplier added 2013

5 *Aerodynamic Forces*

The VPP assumes that each individual sail, mainsail, jib, spinnaker, gennaker or code zero can be characterized by a maximum achievable lift coefficient and a corresponding viscous drag coefficient that are continuous functions of apparent wind angle. The values of these coefficients are adjusted depending on the exact sail type and the mast and rigging configuration. The individual coefficients are then combined into a set of complete sail plan (main and jib, or main and spinnaker) coefficients.

In order to simulate the reduction of heeling force by the crew trimming and changing sails “Flat” and “Reef” parameters are used.

The flat parameter is used to simulate the reduction of the lift coefficient. It reduces from a value of 1.0, associated with maximum lift, to a minimum value of 0.6 for normally rigged yachts¹⁹, i.e. the lift coefficient reduced by 40%.

The reef parameter simulates the reduction of sail area. When reefing is required to achieve optimum performance the genoa sail area is first reduced until the genoa reaches its minimum foot length, if further heeling force reduction is required the mainsail is reefed.

The VPP optimizer is at liberty to de-power the sails by reducing the maximum lift coefficient (Flat) and reduce sail size (Reef) to achieve best performance at each prescribed True wind angle.

5.1 *Methodology*

The aerodynamic forces acting on the yacht are resolved into two orthogonal components, lift and drag. The lift force acts perpendicular to the apparent wind direction and the drag force acts parallel to it. The force model incorporates 3 sources of drag:

- 1) The base drag associated with the windage of the hull, spars, rigging and crew;
- 2) The parasitic drag associated with the skin friction drag of the sails, and the pressure drag associated with flow separation. The parasitic drag is assumed not to depend on the sail lift force, it does however vary with the point of sailing;
- 3) The induced drag, which arises from the three-dimensional nature of the flow around the sails, and the loss of circulation from the head and foot of the sails. The induced drag is assumed to vary as the square of the lift coefficient. A two-dimensional lift dependant drag term is also added to the basic induced drag.

Analysis of the rig begins by ascribing the appropriate coefficient set to the main, jib and offwind sails. The frontal and side areas associated with the mast, hull and rigging are also calculated. Each area has an associated vertical centre of force which represents the height at which all the aerodynamic loads could be concentrated to produce the same overall rolling moment. Because the presence of a wind gradient implies that the wind velocity is a function of height, the vertical heights of the centres of force are used when evaluating the dynamic pressure acting on any aerodynamic surface.

5.1.1 *Individual Sail Areas and 2-Dimensional Aerodynamic Force Coefficients*

The fundamental components of the aerodynamic model are the individual sails, characterised by the following parameters, which are shown diagrammatically in *Figure 13*:

- Sail area
- Centre of effort height above the sail’s datum
- Cl_X and Cd_P versus β_{AW} envelope. (Maximum lift coefficient and parasitic (viscous) drag coefficient versus apparent wind angle).

¹⁹ This minimum flat value of 0.6 is based on the lift force reduction that has been observed in wind tunnel tests.

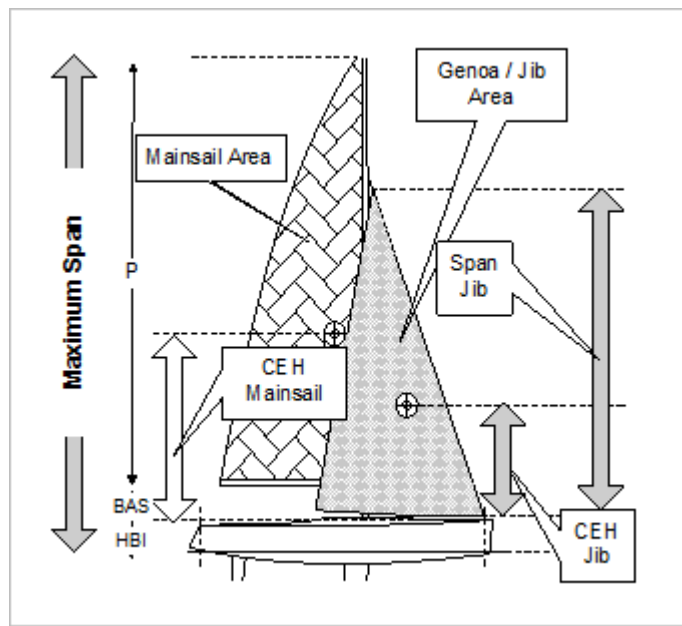

Figure 13 – Sail Parameters

SAILS (Maximum Areas)										
Mainsail	HB	MGT	MGU	MGM	MGL	MSVV	Area	Area (r)	Formula	
	0.210	1.25	2.20	3.60	4.70	22.00	52.10	52.42	$P/8 \cdot (E + 2 \cdot MGL + 2 \cdot MGM + 1.5 \cdot MGU + MGT + 0.5 \cdot HB)$	
Jib/Genoa	JH	JGT	JGU	JGM	JGL	JL	LPG	48.20		$0.1125 \cdot JL \cdot (1.445 \cdot LPG + 2 \cdot JGL + 2 \cdot JGM + 1.5 \cdot JGU + JGT + 0.5 \cdot JH)$
	0.00	0.00	0.00	0.00	0.00	0.00	6.33	Area (r)		
Symmetric	SL	SMG	SF				103.21	103.69	$SL \cdot (SF + 4 \cdot SMG) / 6$	
	14.39		7.60							

Figure 14 shows the individual two-dimensional coefficients for the 3 sail types originally supported by the VPP. The characteristics of the mainsail and jib and spinnaker were derived empirically when the sail force model was introduced. The coefficient values, which are based on cloth area, show typical effects:

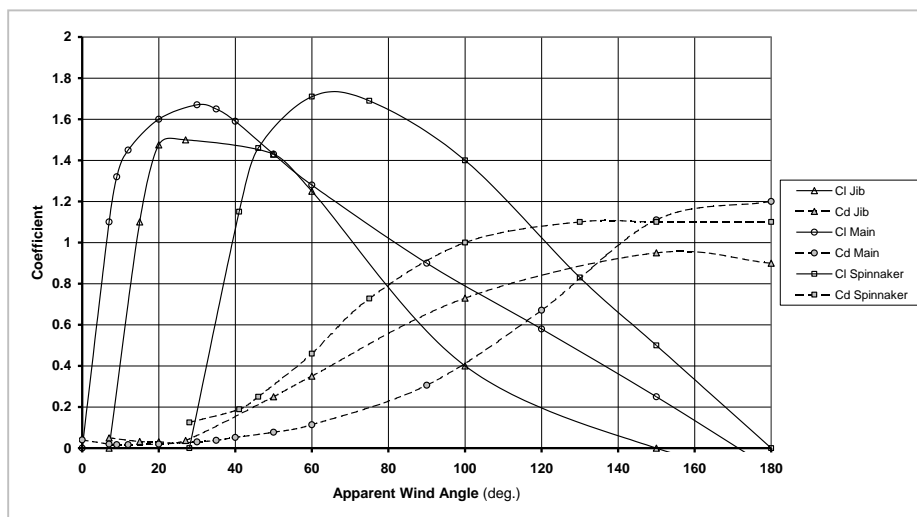

Figure 14 - Basic Sail Force Coefficients

- As apparent wind angle increases a rapid rise in lift to a peak value prior to the onset of separation and stall.
- The sails ‘fill’ at different apparent wind angles, reflecting the different sheeting arrangements and shapes of the sails.
- At an apparent wind angle of 180 degrees, approximating to an angle of attack of 90 degrees, the lift has declined to zero and the drag coefficient increased to 1.0.

5.1.2 “Simplified” Rigging Coefficients

This reflects the ability of yachts with more complex fore and aft staying arrangements to adjust their sails for best performance. The Mainsail and Jib may have varying lift and drag force coefficients depending on the ability to change the camber of the sails by adjustable stays.

For both sail types a low and a high set of lift and drag coefficients exist. In the application of the coefficients adjustable forestays, backstays, and running backstays are considered. The details of the scheme are described in sections 7.2.1 for the mainsail and 7.2.2 for the jib.

5.1.3 De-powering

The de-powering scheme is based on new VPP variables ft_j , and rf_m working with a new²⁰ optimisation parameter RED that replaces the traditional Reef parameter.

ft_j = jib foot parameter $ft_j=1$ full size jib, $ft_j=0$ minimum jib

rf_m = is the main reduction factor, $Rfm=1$ full main, $rfm=0$ no main. Works like the old Reef function but on the mainsail only.

RED is a combination of these 2 factors into a single optimisation parameter.

RED = 2 then $ft_j=rf_m=1$, i.e. full sail

RED=1 then $ft_j=0$, $rf_m=1$, i.e. jib at minimum size

RED < 1 then $ft_j=0$ and $rf_m < 1$.

The progressive de-powering scheme is shown graphically in *Figure 15*. At each stage in the process the current sail area, fractionality and overlap are calculated and the values used to calculate the Effective rig height and vertical centre of pressure position.

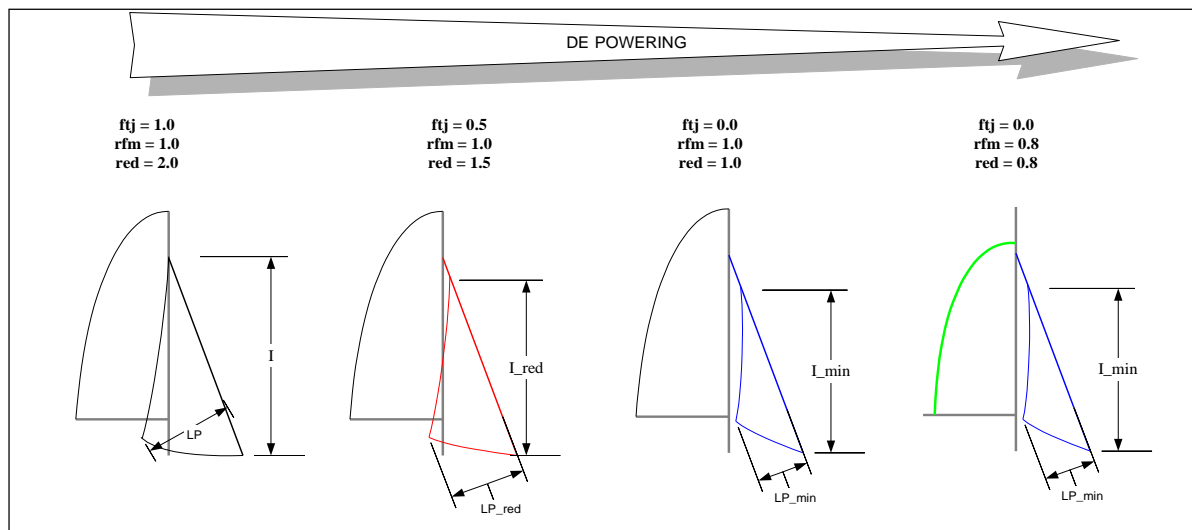

Figure 15 - De-powering scheme

The total sail forces are now calculated during each VPP iteration²¹. The process is described in *Figure 16*.

²⁰ 2009

²¹ rather than adopting the “RIGANAL” approach of the old code where as much of the aero model as possible was pre-calculated before the VPP itself was run. The current approach would not have been possible even 10 years ago due to the extra burden of calculation making the VPP too slow to run routinely.

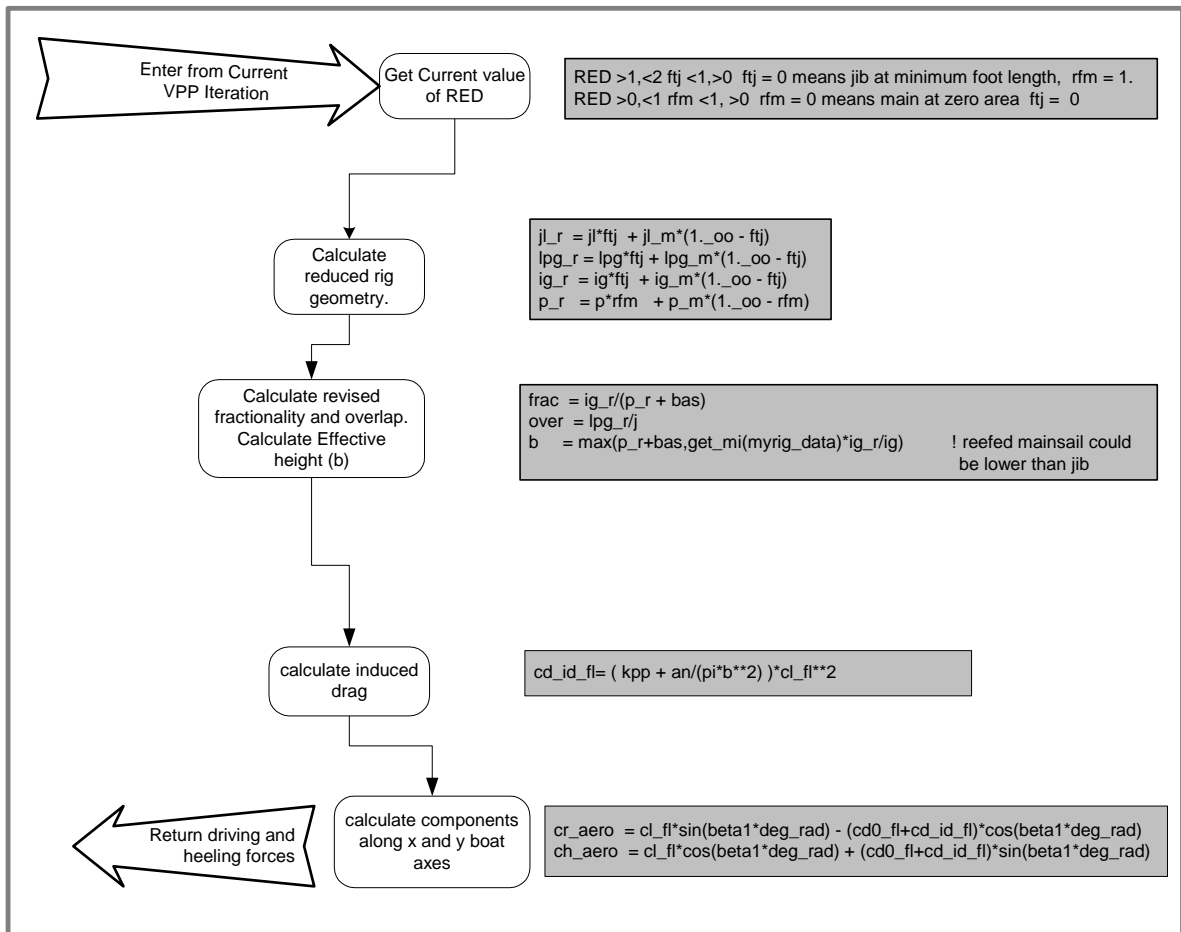

Figure 16 - Routine for de-powering

5.1.3.1 Revised Optimisation Scheme²²

Traditionally (pre 2010) the VPP aerodynamic model has been free to adjust the sail power (Flat) and area (Reef) independently to achieve the highest sailing speed at each True Wind Angle. This is time consuming for the optimisation computer code, and does not reflect the way in which yachts are sailed, in that reefing is usually delayed until the sails are fully flattened. The new sail trimming scheme adopts the following methodology to reduce sail heeling moment as wind speed increases.

- 1) Reduce Flat progressively to Flat_{MIN}
Flat_{MIN} = 0.5 x Flat at 8 knots True wind
- 2) Once Flat_{MIN} is reached reduce jib area progressively to the minimum jib area.
(Still using Flat=Flat_{MIN})
- 3) Once the Minimum jib area is reached reduce mainsail area.
(Still using Flat=Flat_{MIN})

5.2 Sail Areas & Coefficients

5.2.1 Mainsail

5.2.1.1 Mainsail Area

Mainsail area is the physical cloth area of the largest mainsail in the yacht's sail inventory calculated as follows:

²² 2010

$$Area_Main = \frac{P}{8} \cdot (E + 2 \cdot MGL + 2 \cdot MGM + 1.5 \cdot MGU + MGT + 0.5 \cdot HB) \quad [37]$$

The boom depth (BD) limit is $0.06 \cdot E$. If BD exceeds its limit, mainsail area shall be increased by $2 \cdot E \cdot (BD - 0.06 \cdot E)$.

In 2010 a revised scheme for determining the height of the girth sections was adopted. The heights are calculated using the following formula which must be calculated in the order presented.

$$MGMH = \frac{P}{2} + \frac{MGM - E/2}{P} \cdot E$$

$$MGLH = \frac{MGMH}{2} + \frac{MGL - (E + MGM)/2}{MGMH} \cdot (E - MGM)$$

$$MGUH = \frac{MGMH + P}{2} + \frac{MGU - MGM/2}{P - MGMH} \cdot MGM$$

$$MGTH = \frac{MGUH + P}{2} + \frac{MGT - MGU/2}{P - MGUH} \cdot MGU$$

Mainsail rated area is then calculated as follows:

$$Area = \frac{MGL + E}{2} \cdot MGLH + \frac{MGL + MGM}{2} \cdot (MGMH - MGLH) +$$

$$+ \frac{MGM + MGU}{2} \cdot (MGUH - MGMH) + \frac{MGT + MGU}{2} \cdot (MGTH - MGUH) +$$

$$+ \frac{MGT + HB}{2} \cdot (P - MGTH) \quad [38]$$

Thereby, the amount of roach will proportionally increase the rated area from the measured one. A parameter “roach” is calculated to define the planform shape of the mainsail. The roach is calculated in the upper $\frac{3}{4}$ part of the mainsail to avoid any influence of E (that is not measured on the sail). The upper $\frac{3}{4}$ area of the mainsail is calculated as follows:

$$Upper_3/4_Area = \frac{P}{8} \cdot (MGL + 2 \cdot MGM + 1.5 \cdot MGU + MGT + 0.5 \cdot HB) \quad [39]$$

A roach value of zero corresponds to a main with triangular $\frac{3}{4}$ upper part. Negative roaches are accounted as zero. A value greater than this indicates a degree of “big headedness”

$$ROACH^{2013} = \frac{\frac{UPPER_3/4_AREA}{0.375 \cdot P \cdot MGL} - 1}{0.844} \quad [40]$$

The constant 0.844 is introduced to normalize the roach measurement with the roach measured in wind tunnel based on $P \cdot E/2$ triangle.

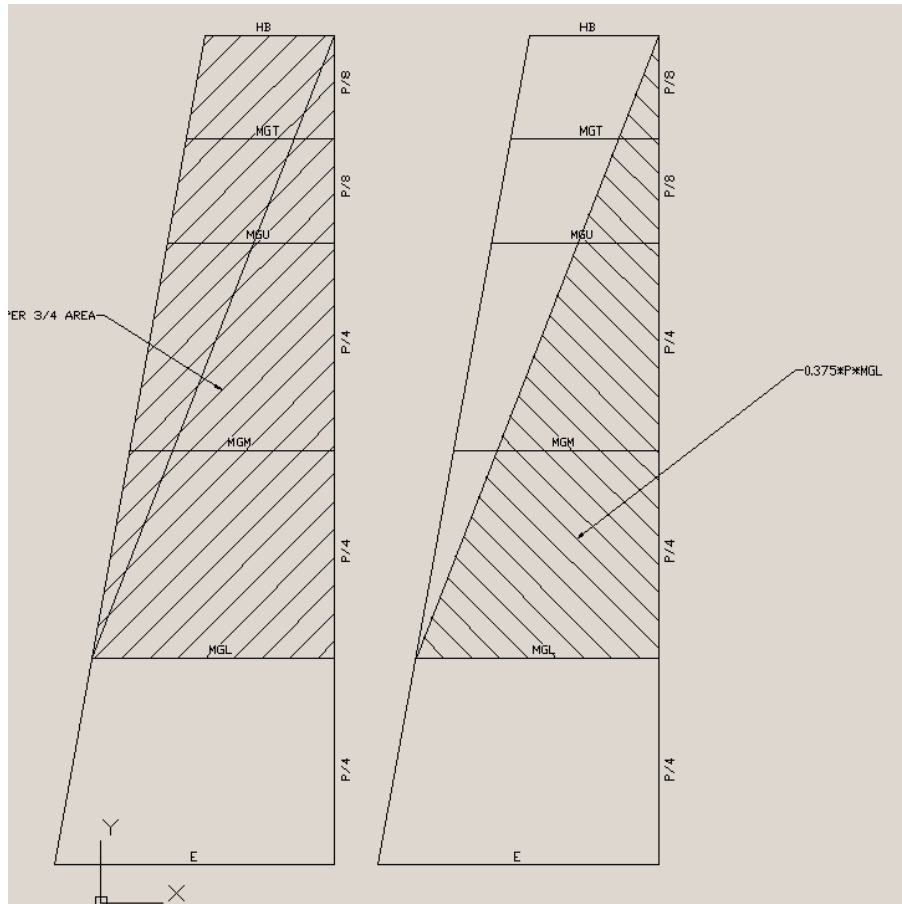

Figure 17 - Roach Calculation

5.2.1.2 Mainsail Coefficients

The mainsail may have either of two coefficient sets as shown in *Table 1*, the standard mainsail and one based on having no adjustable check stays. The “simple” main without checkstays is characterised by a reduced maximum available Lift Coefficient resulting from the inability to increase sail camber in light airs through the use of check stays, as shown in *Figure 18*.

beta	bmnc	0	7	9	12	28	60	90	120	150	180
CL_low	clmnc	0.000	0.862	1.052	1.164	1.347	1.239	1.125	0.838	0.296	-0.112
CL_hi		0.000	0.948	1.138	1.250	1.427	1.269	1.125	0.838	0.296	-0.112
CD_low	cdmnc	0.043	0.026	0.023	0.023	0.033	0.113	0.383	0.969	1.316	1.345
CD_hi		0.034	0.017	0.015	0.015	0.026	0.113	0.383	0.969	1.316	1.345

Table 1 - Mainsail force coefficients

Nomenclature

- beta = Apparent wind angle (deg)
- CD = Drag Coefficient
- CL = Lift Coefficient

The low set of lift and drag coefficients (CL_{low}) is used when there is neither a backstay nor a pair of running backstays or in case of one pair of running backstays only. With two or more backstays (regardless of type) the high set of coefficients (CL_{high}) is applied.

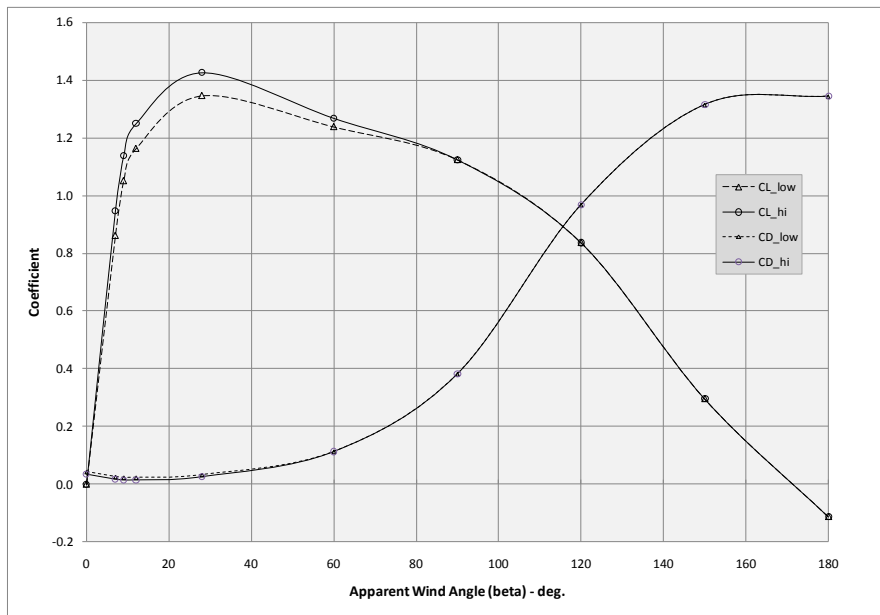

Figure 18 - Alternative Mainsail Force Coefficients²³

Table 2 shows the matrix of rated rigging arrangements and corresponding main sail force coefficient sets.

- L = Low Lift associated with low mainsail adjustability.
- H = High Lift associated with increased mast bend control.
- M = intermediate coefficient set depending on rig fractionality.

Mainsail Coefficients				
BACKSTAY	FORESTAY			
	fixed	adj fwd	adj aft	adj aft&fwd
None	L	L	error (M)	error (M)
Backstay only	L	L	M	M
Running Backstay only	warning (L)	warning (L)	L	L
2 or more Backstays and/or adjustable inner forestay	H	H	H	H

L = C_low

M = C_moderate = C_low*(1-Ccoef/2) + C_high_new*Ccoef/2

H = C_high_new = (C_low + C_high_old) / 2

Table 2 - Application of Alternative Coefficient sets for Mainsails

In the case of a backstay being fitted but without running backstays, a fractionality coefficient f_{Coef} is derived which controls the effect of the backstay on the mainsail shape. This is shown diagrammatically in Figure 19.

$$f_{Coef} = \sqrt{\sin\left(\frac{\pi}{0.6}\right) \cdot \min\left(0.3; \max\left(0; \frac{1}{Fractionality} - 1\right)\right)} \quad [41]$$

²³ C:\Documents and Settings\Andy\My Documents\Projects\ORC Documentation\XLS\New_Coefs_Main_Jib_mod.xls

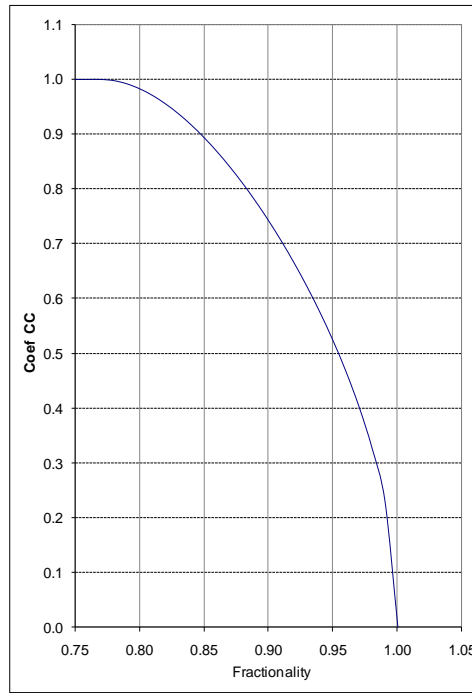

Figure 19 - Fractionality Coefficient

For the configuration with one pair of backstays only, a medium level set of coefficients is calculated

$$C_{medium} = C_{low} \cdot \left(1 - \frac{f_{Coef}}{2}\right) + C_{high} \cdot \frac{f_{Coef}}{2} \quad [42]$$

5.2.1.3 Centre of Effort (CE) calculation

The mainsail centre of effort is calculated as the centre of area of the projected mainsail area, plus a constant to unify the calculation with earlier equations. The constant added to CE/P is 0.024 which makes the center of effort height for a mainsail with default girths = 0.39 x P.

5.2.2 Jib or Genoa

The jib also has 2 possible coefficient sets depending on whether the forestay can be adjusted whilst racing. If it can be adjusted the jib has a higher maximum Lift Coefficient to reflect the fact that sail camber can be increased in light airs by easing the head stay.

5.2.2.1 Genoa Area

Jib rated area is be the biggest area of any jib/genoa in the sail inventory calculated as follows:

$$Jib_Area = 0.1125 \cdot JL \cdot (1.445 \cdot LPG + 2 \cdot JGL + 2 \cdot JGM + 1.5 \cdot JGU + JGT + 0.5 \cdot JH) \quad [43]$$

Using the girths measured as per the ERS. A default Jib Area is calculated from the following formula:

$$Jib_{DEFAULT} = 0.9 \cdot \sqrt{(IM^2 + J^2)} \cdot 0.9 \cdot \frac{J}{2} \quad [44]$$

If Jib Area > Jib_{DEFAULT} then rated area = actual area.

If Jib Area < Jib_{DEFAULT} then rated area = default area.

5.2.2.2 Genoa Aerodynamic Coefficients

A similar approach to the mainsail is applied for the set of lift and drag coefficients of the jib, as shown in Table 3. The low set of coefficients is applied only when there is neither a backstay nor an adjustable forestay. If the forestay is adjustable or in the case of one or more pairs of running backstays the high set of coefficients is used. The coefficients are plotted in Figure 20.

beta	bjyb	7.000	15.000	20.000	27.000	50.000	60.000	100.000	150.000	180.000
CL_low	cljnb	0.000	1.000	1.375	1.450	1.430	1.250	0.400	0.000	-0.100
CL_hi	cljyb	0.000	1.100	1.475	1.500	1.430	1.250	0.400	0.000	-0.100
CD_low	cdjnb	0.050	0.032	0.031	0.037	0.250	0.350	0.730	0.950	0.900
CD_hi	cdjyb	0.050	0.032	0.031	0.037	0.250	0.350	0.730	0.950	0.900
dCL	dclj	0.000	0.100	0.100	0.050	0.000	0.000	0.000	0.000	0.000

Table 3 - Genoa Force Coefficients

When a genoa with LPG>130% J has battens, its coefficients are modified multiplying them by the following factors:

beta	7	15	20	27	50	60	100	150	180
kcl	1.00	1.04	1.05	1.06	1.05	1.04	1.03	1.00	1.00
kcd	0.85	0.83	0.83	0.83	0.88	0.88	1.00	1.00	1.00

the coefficients are smoothed from being completely in effect at LPG=130% to being completely ineffective at LPG=110%J.

Headsail Coefficients				
BACKSTAY	FORESTAY			
	fixed	adj fwd	adj aft	adj aft&fwd
None	L	H	error (M)	error (H)
Backstay only	L	H	M	H
Running Backstay only	warning (H)	warning (H)	H	H
2 or more Backstays	H	H	H	H

L = C_low
 M = C_moderate = C_low*Coeff + C_high*(1-Coeff)
 H = C_high

Table 4 - Application of Alternative Coefficient sets for jibs

Table 4 shows the matrix of rated rigging arrangements and corresponding jib/genoa sail force coefficient sets.

L = Low Lift associated with a non adjustable forestay which does not allow genoa camber to be controlled.

H = High Lift associated with increased forestay control.

In case of a backstay being fitted but no running backstays, a medium level set of coefficients is calculated similar to the procedure applied for the mainsail. The intermediate coefficients are derived with the same fractionality coefficient f_{Coef} given above by using the following formula:

$$C_{medium} = C_{low} \cdot f_{Coef} + C_{high} \cdot (1 - f_{Coef}) \tag{45}$$

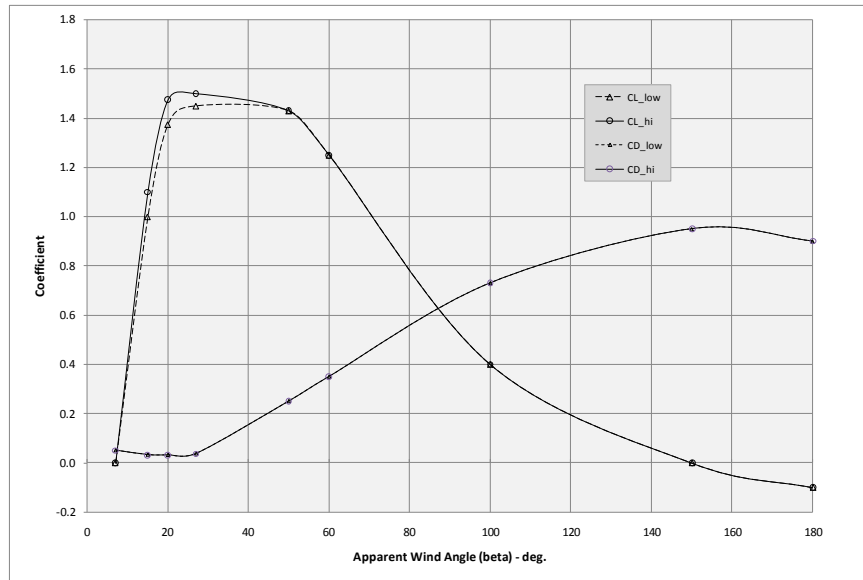

Figure 20 - Alternative Jib Force Coefficients

5.2.2.3 Roller Furling Genoa

For a roller furling genoa the lift coefficient is reduced by the following amount at each apparent wind angle. The modified coefficients are applied only if the genoa has an LP > 110% of J, and there is only one headsail carried onboard.

AWA	7.0	15.0	20.0	27.0	50.0	60.0	100.0	150.0	180.0
Delta Cl	0.0	0.10	0.10	0.05	0.00	0.00	0.0	0.0	0.0

5.2.2.4 Poled out jib

In 2011 the poled out jib coefficients were removed. For non-spinnaker handicaps on downwind courses the sail coefficients are taken as those for an asymmetric spinnaker set on a pole with a spinnaker sail area equal to $1.035 \times$ the area of the largest rated headsail carried onboard.

5.2.2.5 No Spinnaker Configuration

For the “No Spinnaker” configuration the yacht is run through the VPP with the normal jib force coefficients. Also a sail set called “jib downwind” between True Wind Angles of 60° and 180° using the asymmetric on centerline coefficients and a sail area equal to the jib area. For handicapping the best speed from each of the polar curves is selected.

5.2.2.6 Jib Centre of Effort (CE) calculation

The jib centre of effort is the centre of area of the jib planform, calculated using a trapezoidal integration of the measured girths.

5.2.3 Spinnakers

The following configurations can be handicapped:

- 1) No spinnaker
- 2) Symmetric spinnaker on pole only (with and without CODE 0)
- 3) Asymmetric spinnaker on tacked on CL (with and without CODE 0)
- 4) Asymmetric spinnaker on pole , asymmetric on CL and symmetric on pole (with and without CODE 0)

5.2.3.1 Spinnaker Area

The VPP and the sail areas published on the certificate are now actual sailcloth areas²⁴. The concept of a “rated sail area” that reflects different types of sail plan has been replaced by more sophisticated force coefficient sets.

$$Spinnaker_area = \frac{SL \cdot (SF + 4 \cdot SMG)}{6} \quad [46]$$

For asymmetric spinnakers and code zero's, $SL = (SLU+SLE)/2$.

A default spinnaker area is calculated. From 2011 onwards if the measured area is less than the default area the default spinnaker area is used in the VPP calculation. Default (minimum) values for symmetric spinnakers:

$$SL_{default} = 0.95 \cdot \sqrt{ISP^2 + J^2} \quad [47]$$

$$SF_{default} = 1.8 \cdot \max(SPL, J) \quad [48]$$

$$SMG_{default} = 0.75 \cdot SF_{default} \quad [49]$$

If SPL is not recorded it will be set $SPL=J$

For the asymmetric spinnaker:

$$ASL_{default} = 0.95 \cdot \sqrt{ISP^2 + J^2} \quad [50]$$

$$ASF_{default} = \max(1.8 \cdot SPL; 1.8 \cdot J; 1.6 \cdot TPS) \quad [51]$$

$$AMG_{default} = 0.75 \cdot ASF_{default} \quad [52]$$

In the case that the configuration is only asymmetric on CL and TPS is not recorded it will be set $TPS = J + SFJ$

If there is no spinnaker aboard; boat will be rated with an asymmetric spinnaker tacked on centerline with the same area as the largest jib/genoa.

5.2.3.2 Force Coefficients²⁵

beta	28	41	50	60	67	75	100	115	130	150	180
Cd	0.213	0.321	0.425	0.587	0.598	0.619	0.850	0.911	0.935	0.935	0.935
Cl	0.000	0.978	1.241	1.454	1.456	1.437	1.190	0.951	0.706	0.425	0.000

Table 5 - Symmetric Spinnaker Force Coefficients

beta	28	41	50	60	67	75	100	115	130	150	180
Cd	0.191	0.280	0.366	0.523	0.448	0.556	0.757	0.790	0.776	0.620	0.400
Cl	0.026	1.018	1.277	1.471	1.513	1.444	1.137	0.829	0.560	0.250	0.120

Table 6 - Asymmetric Spinnaker tacked on centreline Force Coefficients

Beta	28	41	50	60	67	75	100	115	130	150	180
Cd	0.170	0.238	0.306	0.459	0.392	0.493	0.791	0.894	0.936	0.936	0.936
Cl	0.085	1.114	1.360	1.513	1.548	1.479	1.207	0.956	0.706	0.425	0.000

Table 7 - Asymmetric Spinnaker tacked on a pole Force Coefficients

²⁴ 2008 change

²⁵ 2011

The Spinnaker Coefficients are plotted in *Figure 21*.

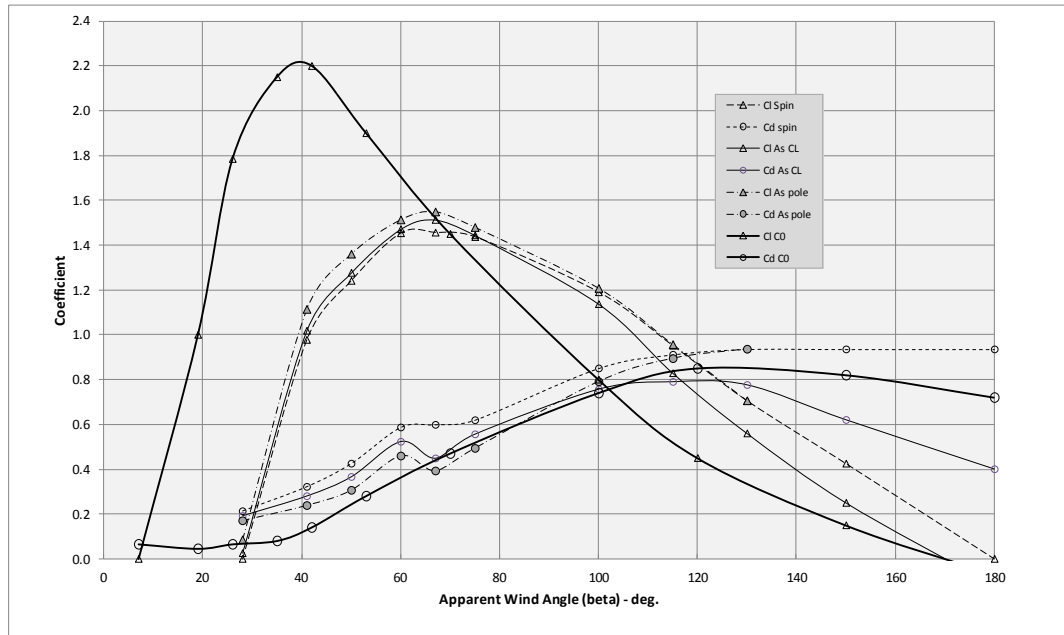

Figure 21 - Spinnaker and Code zero Coefficients

5.2.3.3 Reduction in Drive Force from large spinnakers in light airs (*ShapeFunction*)²⁶

The SHAPE function was introduced some years ago as it is an observed effect that large spinnakers are particularly inefficient in light airs. To address this “type-forming” towards smaller spinnakers, a power loss factor for larger sails was developed so reducing the effective area of a spinnaker that is bigger than the “reference area”. The new formulation only considers the space available for the spinnaker to be flown in, defined by ISPC, J and pole type.

These are the new features of the shape function:

- The reference area depends on whether a pole or a bowsprit configuration is used, due to the different space available in each case;
- The shape function reference area now has a "head angle" relationship as well as being related to ISP and TPS in order to bring in the effect of gravity making it harder to fly a lower aspect ratio sail;
- The shape function now relates to apparent wind speed rather than true;
- The ISP used by the reference area is the full ISP for pole boats at AWA < 80°, blending to ISPC at AWA > 90°, in order to simulate the practice of tacking very light wind sails onto a short STL length bowsprit to gain more projected area. ISP for sprit boats is the full ISP throughout the range of AWA.

This is the new SHAPE function formulation:

$$\begin{aligned} \text{SHAPE} &= 1 + \text{Wind_Speed_Range_Multiplier} * (\text{Shape_factor} - 1) \\ \text{Wind_Speed_range_Multiplier} &= 1 \text{ if AWS} < 5, 0 \text{ if AWS} > 6 \text{ (the Multiplier} = 1 \text{ for} < 5 \\ &\text{AWS, 0 for} > 6 \text{ AWS, and Interpolates between)} \\ \text{Shape_factor} &= 1 - 3 * (\text{Ref_Area} / \text{Area_actual} - 1)^2 \text{ with } 0.8 < \text{Shape_factor} < 1.0 \\ \text{Area_actual} &= \text{MAX} (\text{SPI_AREA}, \text{Ref_Area}) \\ \text{Ref_Area} &= 1.04625 * \text{ISPC} * \text{SPLc} / \text{Head_Angle_Corrector} \\ \text{Head_Angle_Corrector} &= \text{ARCTAN} (2.5 * (\text{SPL;TPS}) / \text{ISPC}) \end{aligned}$$

The formulation ensures that the "rated area" increases slightly with the increase of TPS, even in 5 kts AWS, and the reference area is more appropriate to a small sail for the limited space and AWA. Being related to AWS, it is much more physically realistic and should mean that for a light boat the effect

²⁶ 2011 & 2012

disappears at about 10kts TWS, while for a 37' heavy cruiser-racer the effect tapers down at 12 kts TWS with the transition represented in *Figure 22*. For spinnaker area below default area, no further reductions will be made, while the maximum reduction will be limited to 75% of measured area.

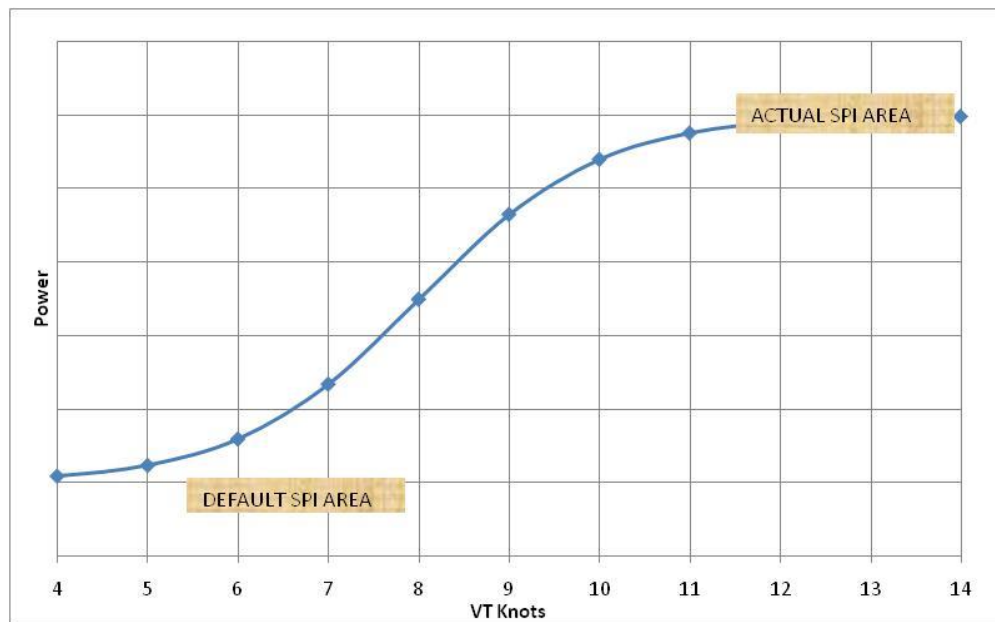

Figure 22 - Large Spinnaker Force Correction in light winds

5.2.3.4 Spinnaker Centre of effort height

The centre of effort height is $0.565 \times \text{ISP}$ above the base of I.

5.2.3.5 Spinnaker Jib Crossover²⁷

The 2011 modifications to the spinnaker coefficients were largely driven by the desire to “force” the VPP to adopt crossover points from spinnaker to jib at apparent wind angles that more closely reflect the angles observed whilst sailing.

Moreover, in 2014 the maximum heel angle allowed under spinnaker was reduced from about 26.5 to about 21.5 degrees. Numbers are approximated because when approaching the limit value 'soft' boundary is modeled in terms of a rapidly increasing resistance. The minimum REEF factor allowed was fixed at: $0.85 \times \text{Spin. Area} / \text{Default Spin. Area}$

5.2.4 Spinnaker tack position “Power” Function

In order to more equitably handicap the influence of increasing the length of the spinnaker pole or bowsprit relative to the spinnaker, gennaker and Code zero mid-girth a “power” function was introduced to the mainsail blanketing algorithm as shown in the equation below.

The power calculation is triggered by the value of the term f_{sp} , If this is less than 0.0 then the spinnaker pole is considered longer than the norm and the power function increases above 1.0

The Power Function of 2013 has an apparent wind angle linkage, so that the effective reference area is essentially similar to what would be ideal for the wind angle considered. This addresses several handicapping issues: deep running symmetrical sails on heavy boats now need to be bigger relative to the space available than asymmetrical sails on lighter boats that sail higher angles in order to collect the same Power Function credits.

²⁷ 2011

First, bowsprits are considered shorter than poles (a reduction factor of 0.9 is applied to TPS) while a correction of height available is taken into account for poles as $0.16 \cdot \text{LSM1}$, considering that poles are set higher than the bowsprit.

The power formulation²⁸ is:

$$\begin{aligned} \text{Power} &= 0.92 + (\text{ABS}(\text{fsp}))^{1.5}, \text{ but not to exceed } 1.2 \\ \text{Fsp} &= \min((1 - 1.488 \cdot \text{SPLc} / (\text{SPL_AREA} / (\text{ISPc} \cdot \text{AWAfact})) - 0.17, 0) \\ \text{SPLc} &= \text{SPL} \text{ or } 0.9 \cdot \text{TPS} \\ \text{ISPc} &= \text{ISP} \text{ (for sprit) or } \text{ISP} - 0.16 \cdot \text{LSM1} \text{ (for poles)} \\ \text{AWAfact} &= 0.5196 \cdot \text{AWA}^{0.1274} \text{ if } \text{AWA} > 28^\circ, 0.794 \text{ if } \text{AWA} < 28^\circ \\ \text{CE height} &= 0.517 \cdot \text{ISPc} + 0.16 \cdot \text{LSM1} \text{ for poles or } 0.517 \cdot \text{ISPc} \text{ for sprit,} \end{aligned}$$

In 2014 power function was fine tuned: the upper last 5% of mast height is for free in ISP for the sake of power function calculation: $\text{ISPc} = \min(\text{ISPc}, 0.95 \cdot (\text{P} + \text{BAS}))$.

The fsp formulation includes ISP and TPS, so in effect it has dimensions of an area. The AWA factor is a modification on this area to consider a boat type that needs to sail at 175 degrees and can fill the available space with a larger spinnaker more effectively than a boat that needs to sail at 100 degrees that would not benefit from such a large spinnaker. So if a typical A1 area is set at a typical A1 angle, it should reach a similar power factor to a typical S4 or A4 area set at their typically-wider angles. The “Power” function does not credit poles or bowsprits shorter than the norm, and the maximum power increment is 20% above the base level.

In order to calculate the force from the spinnaker/gennaker the sail area is multiplied by the Power function.

5.2.5 Headsails set flying

Since 2014 the former code0 has been renamed as *headsail set flying*, and some modifications have been introduced to the rules, affecting the way its area is computed, and its performances. The flying headsail area is now measured similarly to the jib and genoa (which are headsails too, but not set flying).

Regarding the aerodynamic coefficients, it has been acknowledged that there is a big variety of flying headsails: they could be conceived for close reaching and upwind sailing similarly to a genoa or jib, or they can be designed to give their maximum performance at wider angles. With the aim of catching this variety two characteristics of the sail are taken into account: the presence of battens and that of a *tight luff*. A flying headsail designed for upwind sailing will normally have a tight luff and battens, while a sail for wider angles will have a loose luff, and will not be able to perform as well upwind.

5.2.5.1 Area calculation and legacy conversion

The area formula for flying headsail is the same as for jibs/genoa (now all called headsails):

$$\text{Area} = 0.1125 \cdot \text{JL} \cdot (1.4444444 \cdot \text{LPG} + 2 \cdot \text{JGL} + 2 \cdot \text{JGM} + 1.5 \cdot \text{JGU} + \text{JGT} + 0.5 \cdot \text{JH})$$

The old code0s area was based on spinnaker formula:

$$\text{Area}_{\text{old}} = 0.5 \cdot (\text{SLU} + \text{SLE}) \cdot (4 \cdot \text{AMG} + \text{ASF}) / 6$$

During the transition 2013-2014 for legacy code0s a conversion formula that preserves $\text{JGM}/\text{LPG} = \text{AMG}/\text{ASF}$ has been adopted. This formulation derives some *virtual* girths, based on the old spinnaker-like measures AMG, ASF, SLU, SLE. Moreover, a factor is applied to the old area calculation, in order to reproduce the same performances with the new approach.

TRANSITION 2013-2014 formulas

Area = 0.94*A_old
MFR = AMG/ASF

JL = SLU
JGM = MFR*LPG
JH = 0.05*LPG
JGT = 0.25*JGM + 0.75*JH
JGU = 0.5*(JH+JGM)
JGL = 0.5*(LPG+JGM)
with above relations it results, after simplifications:
LPG = Area/[0.1125*JL*(2.544444+4*MFR)]

5.2.5.2 Default area

The headsail set flying has a default area, that we calculated by conversion of the old code0 default area:

$$\text{area_default} = 0.405 * \sqrt{\text{isp}^2 + \text{tps}^2} * \text{tps}$$

A minimum sail area had to be established for the flying headsail to be considered: this was for avoiding penalization of boats having spinnaker staysails (that are flying headsails), hoisted inside the headstay.

The test is:

$$\text{if} (\text{area} < \max(\text{jib_area}, 0.405 * \sqrt{\text{i}^2 + \text{j}^2})) \text{ .AND. } \text{area} < 0.762 * \sqrt{\text{isp}^2 + \text{j}^2} * \text{tps})$$

Put into words, if the sail area is smaller than the smallest between the jib area and the default area, it is not considered as an active flying headsail.

5.2.5.3 Center of effort

The centre of effort of the flying headsails is 0.38*ISP above the base of ISP

5.2.5.4 Aero coefficients

Loose luffed

Coefficients are derived from those of the former code0, taking into account the conversion factor from old area formula to new one (0.94) and also taking into account the old internal vpp factor for asymmetric spinnakers (0.72). Such coefficients were used for the loose luffed type.

beta	7	19	26	35	42	53	70	100	120	150	180
Cl	0.000	0.766	1.367	1.647	1.685	1.455	1.111	0.613	0.345	0.115	-0.054
Cd	0.050	0.034	0.050	0.061	0.107	0.214	0.360	0.567	0.651	0.628	0.5510

The *battened* sail coefficients are obtained by multiplying the above ones for a factor:

beta	7	19	26	35	42	53	70	100	120	150	180
Mult Cl-LL	1.000	1.040	1.055	1.060	1.060	1.055	1.055	1.033	1.025	1.000	1.000
Mult Cd-LL	0.830	0.830	0.830	0.830	0.880	0.880	0.980	1.000	1.000	1.000	1.000

thus obtaining

LOOSE LUFFED SAILS OUTSIDE FORETRIANGLE with battens

Beta	7	19	26	35	42	53	70	100	120	150	180
Cl-batt	0.000	0.797	1.442	1.746	1.786	1.535	1.172	0.633	0.353	0.115	-0.054
Cd-batt	0.041	0.029	0.041	0.051	0.094	0.189	0.353	0.567	0.651	0.628	0.551

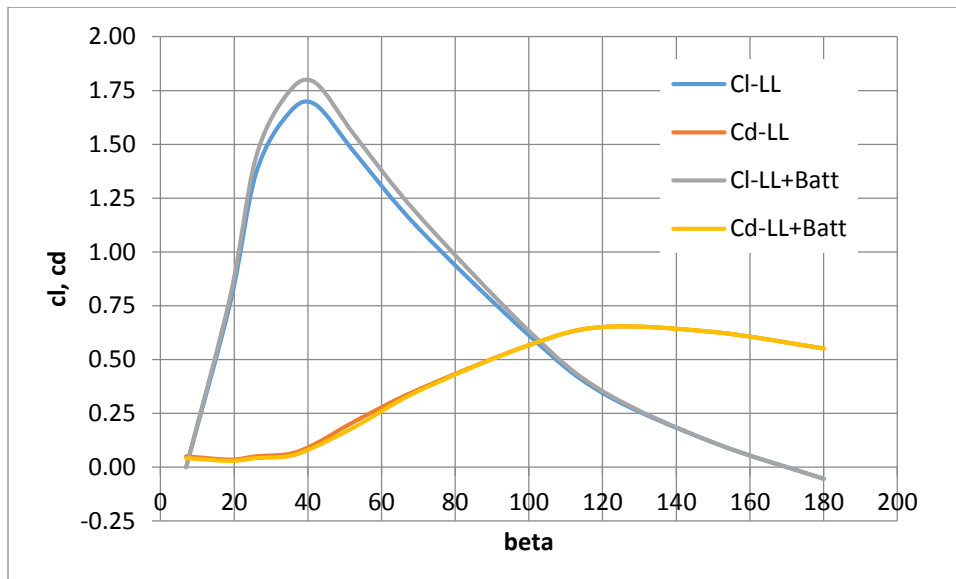

Lift and drag coefficients of loose luffed flying headsails.

Tightluff

Regarding the tightluff flying headsail, a number of modifications were introduced compared to the loose luffed. First of all, it has been chosen a criterium for recognizing a sail having a tight luff. This is based on the comparison of the luff length with the foretriangle available, which is made by the ISP and TPS. Moreover, an additional test is performed on the JGM/LPG ratio.

$$\text{if}(jl < \sqrt{\text{isp}^2 + \text{tps}^2}).\text{AND}.\text{jgm}/\text{lpg} < 0.6)$$

When the sail is battened the test is more severe, considering only the luff and not the girths ratio. Then, the coefficients have been modified in order to improve the upwind performances. Beside this, the effective height calculation has been copied from that of the jib, and also the crew position, thus leaving the crew always to windward, contrary of what happens with spinnakers (and loose luffed headsails).

TIGHT LUFF COEFFICIENTS, NON BATTENED:

beta	7	15	19	26	35	42	53	70	100	120	150	180
CL	0.0000	0.7650	1.0370	1.3818	1.6468	1.6851	1.4553	1.1106	0.6128	0.3447	0.1149	-0.0536
CD	0.0500	0.0370	0.0310	0.0350	0.0613	0.1072	0.2145	0.3600	0.5668	0.6511	0.6281	0.5515

The aim was to obtain upwind performances similar to those of a jib of same area, collapsing to the loose luffed ones at larger angles.

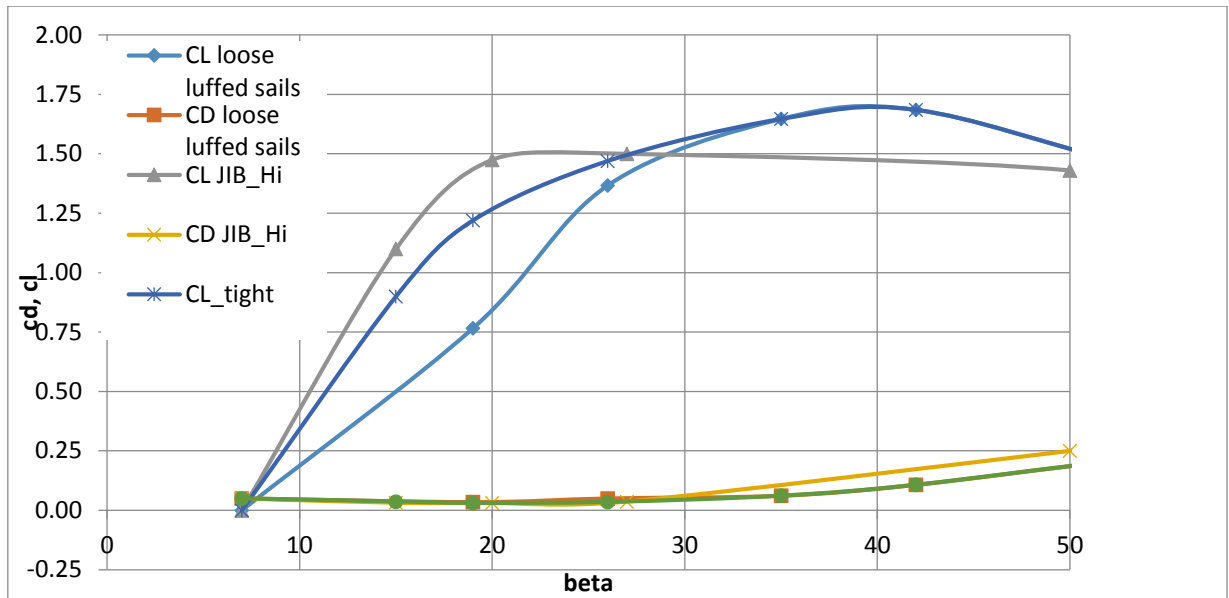

Aero coefficients of loose luffed, tight luffed flying headsail and jibs.

The battened coefficient are obtained using the same multiplier as for the loose luffed sail.

5.3 Windage Forces

The windage drag is incorporated into the force balance by adding to the aerodynamic drag a windage drag determined from equation [53].

Each of the (n) windage elements is ascribed its own dynamic head (qn) based on an apparent wind velocity appropriate to its centre of effort height (ZCE), reference area (A) and drag coefficient (Cd).

$$D_{WINDAGE} = \sum_1^n q_n \cdot A_{REF} \cdot Cd_n \tag{53}$$

The windage drag for each element is calculated at apparent wind angles of 0 and 90 degrees and a shape factor is used to calculate the drag coefficient at intermediate angles. The calculation of Centre of Effort Height (ZCE), Drag Coefficient (Cd0) and reference area (AREF) at apparent wind angles of 0 and 90 degrees is shown in the table below, the values for 180 degrees are the same as those for the headwind case.

Apparent. Wind Angle 0°			
WINDAGE ELEMENT	ZCE	CD	AREF
HULL	0.66(FBAV+Bsinφ)	0.68	FBAV*B
MAST-Sail	HBI+EHM*reef/2	0.4a	Front Area
MAST-Bare	HBI+EHM*(1-reef)/2	0.8a	Front Area
RIGGING	HBI+I/2	1.0b	I*f(Default. Rigging wt.)
Non round rigging ²⁹	HBI+I/2	0.25b	I*f(Default. Rigging wt.)
CREW	HBI+0.5+B/2sinφ	0.9	0.25
Apparent. Wind Angle 90°			
WINDAGE ELEMENT	ZCE	CD	AREF
HULL	0.66(FBAV+Bsinφ)	0.68	f(HSA*L,φ)
MAST-Sail	HBI+EHM*reef/2	0.6a	Side Area
MAST-Bare	HBI+EHM*(1-reef)/2	0.8a	Side Area
RIGGING	HBI+I/2	1.0b	I*f(Default. Rigging wt.)
CREW	HBI+0.5+B/2sinφ	0.9	0.5*Mvblcrew

a modified by EDM factor for non standard mast section aspect ratio.
b plus spreader factor = 0.2

Table 8 - Windage force model

Hull side area (HSA)

$$HSA = \int_0^n \text{Freeboard} \, dl \quad [54]$$

where n = number of measurement stations.

5.3.1 Rigging

The drag of the rigging wire is calculated based on the default rigging weight. The square root converts wire cross-sectional area to wire diameter, and the factor of 2 means four stays.

$$\text{Diameter_of_Rigging_wire} = 2 \cdot \sqrt{(4 \cdot d0 \cdot WT_Deflt_Rigng / MI / \text{Steel_density} / \pi)} \quad [55]$$

$$\text{Area_Rigging_Wire_windage} = I \cdot \text{Diameter_of_Rigging_Wire} \quad [56]$$

$$Cd0_Rigging_Wire = CD_Rigging_Wire \cdot (1 + \text{spreader_Factor_windage}) \quad [57]$$

5.3.1.1 Spreaders

If the rig has bona-fide spreaders their drag is added in as a multiplier as shown in *equation [57]***Error! Reference source not found.**, where `spreader_Factor_windage` is set to 0.2.

5.4 Total Aerodynamic Lift and Drag

The next phase is to combine the individual sail's characteristics to produce a set of lift and drag coefficients that describe the aerodynamic behavior of the entire rig.

This is accomplished by a weighted superposition of the individual sail force coefficients at each apparent wind angle. This process is described in more detail in section 7.4.1.

The weight given to each sail's coefficients during this process is proportional to the product of its area and the "blanketing" factor, which modifies the individual sails coefficients depending on the apparent wind angle. After summing the weighted coefficients the total is normalized with respect to the reference sail area (A_{REF}).

When calculating the collective vertical centre of force the weight given to each sail's contribution is proportional to the product of the area, the blanketing factor, and the total force coefficient.

The induced drag coefficient is calculated from knowledge of the effective rig height. (H_E)

$$Cd_1 = \frac{Cl^2 \cdot A_{REF}}{\pi \cdot H_E^2} \quad [58]$$

The effective rig height is calculated from the sail plan geometry at each iteration of the VPP through the aerodynamic force calculation loop.

The effective rig height is a function of:

- the mainsail roach
- the relative positions of the mainsail head and the jib head expressed as "fractionality" and
- the overlap of the headsail

5.4.1 Lift and Drag of complete sail set

The aggregate maximum lift and linear parasite drag coefficients are the sum of each sail component's contribution normalized by reference area, and modified by a blanketing function B_i :

$$Cl_{max} = \sum Cl_{max_i} \cdot B_i \cdot \frac{A_i}{A_{ref}} \quad [59]$$

$$Cdp = \sum Cdp_i \cdot B_i \cdot \frac{A_i}{A_{ref}} \quad [60]$$

A typical form of the collective sail force coefficients is shown in *Figure 23*. The “Drag” Curve is the parasitic drag contribution, and the Total Drag curve includes the induced drag contribution.

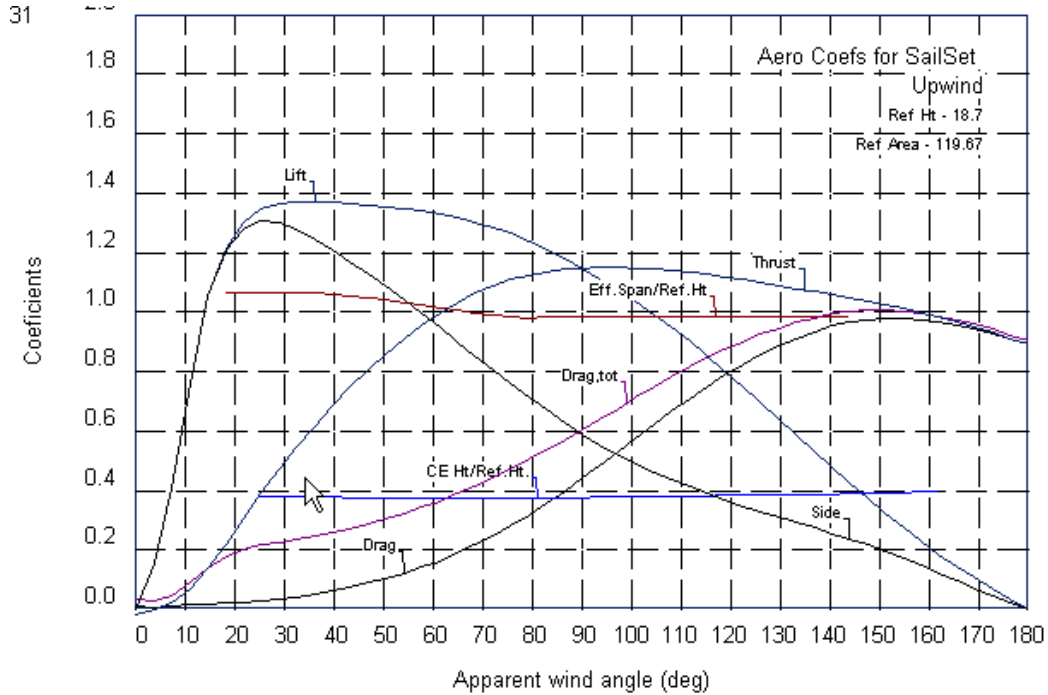

Figure 23 - Typical Form of “Collective” Upwind Sail Force Coefficients

5.4.2 Center of Effort Height

Center of effort height Z_{ce} is evaluated by weighting each sail’s individual center of effort height by its area and partial force coefficient (comprised of lift and linear component of parasitic drag):

$$Z_{ce} = \sum Z_{ce_i} \cdot \sqrt{Cl_{max_i}^2 + Cdp_i^2} \cdot B_i \cdot A_i / A_{REF} / \sqrt{Cl_{max}^2 + Cdp^2} \quad [61]$$

5.4.2.1 Jib Twist³⁰

The centre of effort height (Z_{ce}) of the total sailplan is reduced linearly with the jib foot (ftj) parameter:

$$Z_{ce} = Z_{ce_{ftj=0}} - \text{deltaCEH} \quad [62]$$

Z_{ce} is lowered when the jib area starts to be reduced ($ftj=1$, or REEF=1), and is lowered to a maximum value of 5% of IG when the jib area is reduced to its minimum value ($ftj=0$, which means REEF=0.5).

$$\text{deltaCEH} = (1 - ftj) \cdot 0.05 \cdot IG \quad 0 \leq ftj \leq 1 \quad [63]$$

5.4.3 Induced Drag

In order to calculate the induced drag component an efficiency coefficient is derived. The efficiency coefficient is such that when multiplied by the collective lift coefficient squared it yields the collective induced drag of the sails. The efficiency coefficient is comprised of 2 parts;

- The 2 dimensional part describing the increase of viscous drag that occurs as the sail produces more lift,
- and the “induced drag” which depends on the effective rig height.

5.4.3.1 Quadratic Parasite Drag

The viscous drag of the sails varies according to the square of the lift coefficient. This quadratic parasite drag coefficient KPP is the sums of the individual sails contributions:

$$KPP = \sum KPP_i \cdot Cl_{max_i}^2 \cdot B_i \cdot A_i / A_{ref} / Cl_{max}^2 \quad [64]$$

5.4.3.2 Effective rig height

Three parameters - “fractionality”, “overlap” and “roach”- are determined in order to calculate the Effective rig height which determines the induced drag of the sails.

$$\begin{aligned} \text{Fractionality} &= I_{current} / (P_{current} + BAS) \\ \text{Overlap} &= LPG_{current} / J \\ \text{Roach} &= \text{Mainsail Area} / (P \times E / 2) - 1 \end{aligned}$$

The influence of sail plan geometry is first calculated to derive a corrected effective span coefficient as follows:

$$eff_span_corr = 1.1 + 0.08 \cdot (Roach - 0.2) + 0.5 \cdot (0.68 + 0.31 \cdot fractionality + 0.075 \cdot overlap - 1.1) \quad [65]$$

The effective span coefficient is approximately 1.10 with a masthead rig (fractionality = 1.0) and 150% overlap genoa.

The effective span coefficient is then further modified to reflect the fact that as the sails are eased at wider apparent wind angles the effective span is reduced as the sealing of the jib and the hull is lost and the sail interactions become less favourable.

$$cheff_{Upwind} = eff_span_corr \cdot (0.8 + 0.2 \cdot be) \quad [66]$$

$$cheff_{Downwind} = cheff_max_spi \cdot (1.0 + 0.1 \cdot be) \quad [67]$$

The term *be* varies from 1 to zero as apparent wind angle widens from 30 to 90 degrees (*Figure 24*).

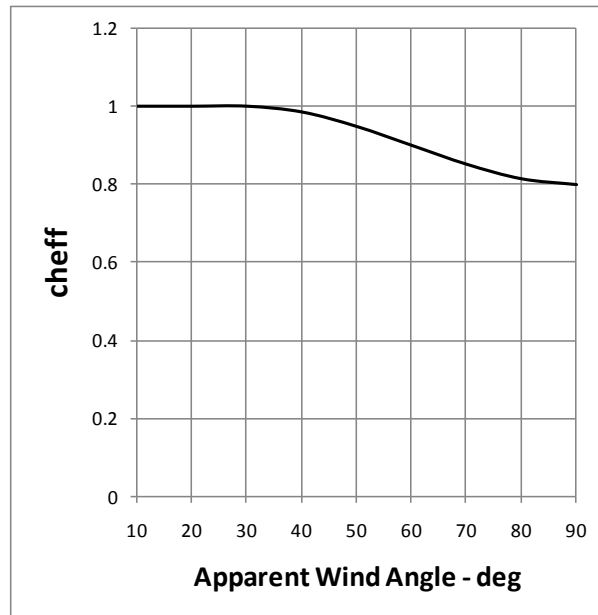

Figure 24 - Variation of Effective span factor with Apparent wind angle

Finally the effective height “heff” is calculated from the product of “cheff” and the the highest point of the sail plan “b” above the water surface. This is either the mainsail head (P+BAS) or jib head (IG). If the jib head is higher than the mainsail head then the average is taken.

$$heff = cheff \cdot (b + HBI) \quad [68]$$

The efficiency coefficient “CE” is comprised of the induced drag coefficient and the parasitic drag coefficient that is proportional to lift squared.

$$CE = KPP + \frac{SailArea}{\pi \cdot heff} \quad [69]$$

Finally at each apparent wind angle the total lift and drag coefficient for the sails can be calculated from the lift, and drag coefficients and the “efficiency coefficient” (CE).

$$Cd_{sails} = Cd_{parasite} + CE \cdot Cl^2 \cdot FLAT^2 \quad [70]$$

$$C_L = FLAT \cdot Cl_{MAX} \quad [71]$$

The FLAT parameter characterizes a reduction in sail camber such that the lift is proportionally reduced from the maximum lift available. Thus flat = 0.9 means 90% of the maximum lift is being used.

What this means in practice is shown in *Figure 25*, in “full power” conditions (FLAT=1) the available aerodynamic force is determined by the maximum Cl and associated Cd. The total Cd at max Cl is affected by Cd_{parasite} and by the effective rig height that determines the induced drag component. When the sails are flattened to reduce the total force, and therefore the heeling moment, it does so along the Cd vs. Cl² line shown in *Figure 25*.

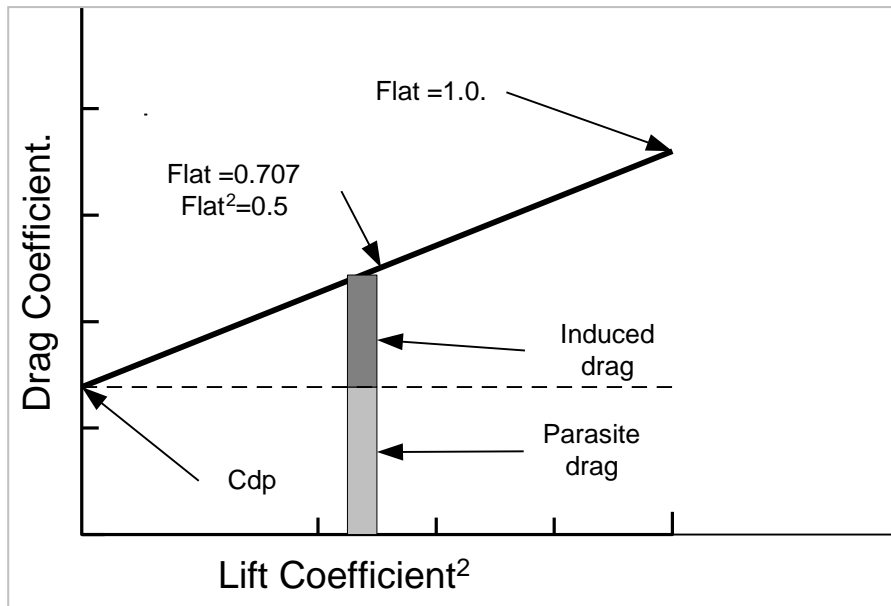
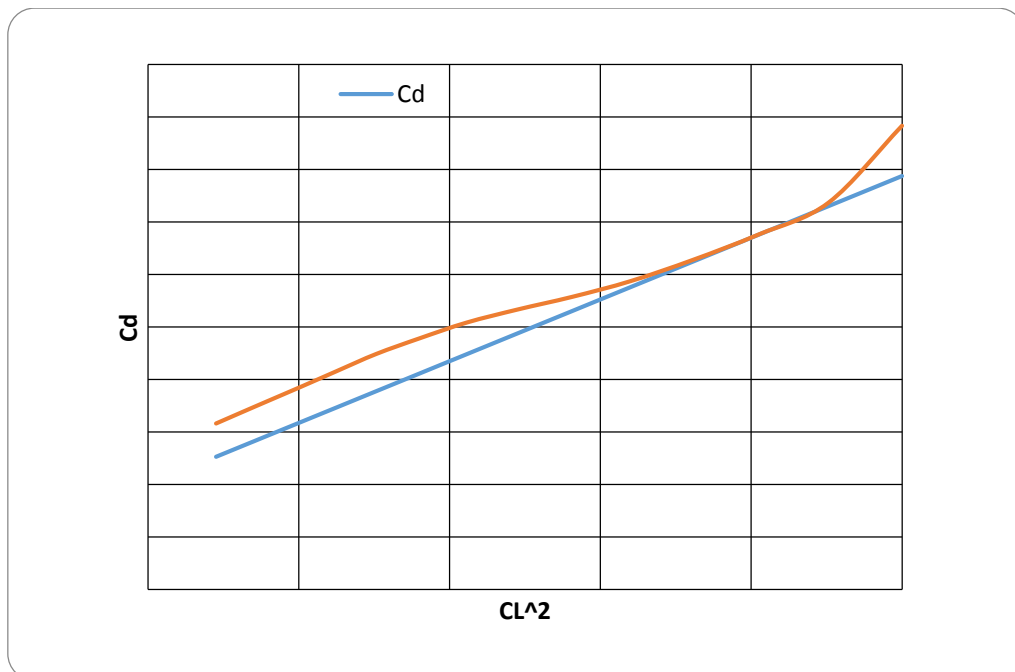

Figure 25 - Variation of Drag Coefficient with Flat parameter

In 2014, the so called depowering curve, C_d vs. Cl^2 of the sailplan is modified in order to follow the non linearities found in the wind tunnel (and in the reality!): both at full power and when the sail are well depowered (that is when the flat parameter is below 0.8), an increase of the drag is found compared to the linear behavior (see Figure, the blue line represents the linear model, red line the modified). For doing this, a multiplier is applied to the drag coefficient of the sailplan, which depends on the position along the depowering curve, in other words on the flat parameter:

Flat	0.10	0.20	0.30	0.40	0.50	0.55	0.60	0.65	0.70	0.75	0.80	0.85	0.90	0.95	1.00
Cd Mult	1.06	1.06	1.06	1.06	1.06	1.06	1.05	1.04	1.03	1.02	1.00	1.00	1.00	1.00	1.06

Therefore the non linear relation C_d - Cl^2 (red line in figure) is obtained.



5.5 Resolution of Forces

In order to determine the total thrust and heeling moment the aerodynamic forces are resolved into two orthogonal components; along the yacht's track (CR) and perpendicular to the mast plane (CH). The windage forces are then added to these components.

Throughout the evolution of the VPP there has been a constant trend that the VPP appears to overstate the value of high righting moment. This has been particularly noticeable in light airs on windward/leeward courses, i.e. Mediterranean conditions.

Two strategies have been adopted in the aerodynamic force model to overcome this, the PHI_UP, and TWIST parameters.

5.5.1 PHI_UP

In the VPP as the yacht heels the apparent wind angle seen by the sails reduces, but on the water the crew have traveler and jib lead controls that permit adjustment of angle of attack.

To reflect this the PHI_UP function modifies the heel angle that is used in the calculation of the apparent wind angle at which the collective curves of lift and drag coefficient are evaluated.

$$phi_up = 10 \cdot \left(\frac{\phi}{30} \right)^2 \quad [72]$$

phi	phi_up
0	0.0
10	1.1
20	4.4

Table 9 - Calculated PHI_UP values

5.5.2 Twist Function

In order to reflect the fact that as sails are de-powered the centre of effort height moves lower a “twist function” was introduced. The extent of the centre of effort lowering was determined from wind tunnel test results, which showed that this effect was proportional to the fractionality (I:(P+BAS)) ratio.

$$Z_{CE} = Z_{CE} \cdot [1 - 0.203 \cdot (1 - flat) - 0.451 \cdot (1 - flat) \cdot (1 - frac)] \quad [73]$$

To reflect the ability of fractionally rigged boats to de-power more readily than mast head rigged boats the twist function links the vertical centre of effort position to the flat parameter.

Fractional rigged boats more lowering of the centre of effort position as the FLAT parameter reduces, as shown in *Figure 26*.

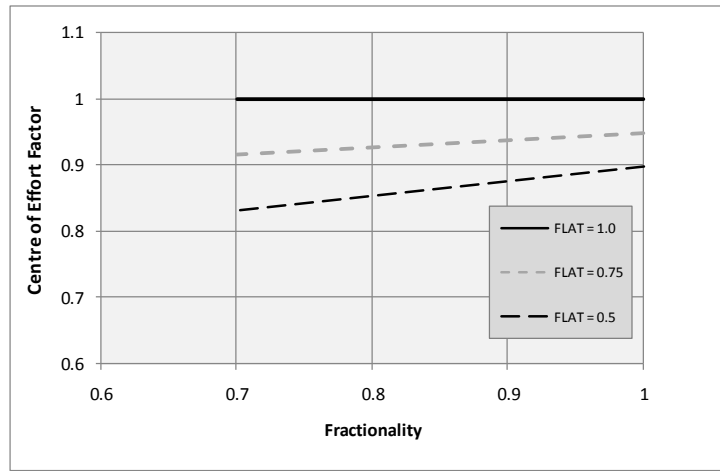

Figure 26 - Twist Function

5.5.3 Thrust and Heeling Force

The collective lift and drag forces from aerodynamic model are resolved as follows:

$$C_R = C_L \sin \beta - C_D \cos \beta \quad [74]$$

$$C_H = C_L \cos \beta + C_D \sin \beta \quad [75]$$

The coefficients are translated into forces:

$$FRA_B4_Windage = C_R \cdot \frac{1}{2} \rho \cdot V_a^2 \cdot A \quad [76]$$

$$FHA_B4_Windage = C_H \cdot \frac{1}{2} \rho \cdot V_a^2 \cdot A \quad [77]$$

Where:

- ρ = air density
- V_A = apparent wind speed
- A = reference sail area

The total aerodynamic force (FRA) is then calculated by adding the windage components:

$$FRA = FRA_B4_Windage + FRA_hull + FRA_mast + FRA_Rigging_Wire + FRA_Crew \quad [78]$$

$$FHA = FHA_B4_Windage + FHA_hull + FHA_mast + FHA_Rigging_Wire + FHA_Crew \quad [79]$$

5.5.4 Aerodynamic heeling Moment

The aerodynamic heeling moment is the sum of the sail heeling moment (HMA_B4_Windage) and the heeling moment from the windage elements.

$$HMA = HMA_B4_Windage + HMA_hull + HMA_mast + HMA_Rigging_Wire + HMA_Crew \quad [80]$$

The sail heeling moment is the product of the heeling force (CH) and the moment arm above the waterline.

$$HMA_B4_Windage = \frac{1}{2} \rho V_A^2 \cdot A_{REF} \cdot CH \cdot (HBI + ZCEB \cdot REEF) \quad [81]$$

6 Hydrodynamic Forces

The VPP hydrodynamic force model divides the drag into two sources; viscous or skin friction drag arising from the flow of the water over the immersed surface, and residuary or wave making drag arising from the creation of surface waves.

The VPP can make performance predictions not only for conventional fin keel yachts, but also water ballasted and canting keel yachts that have asymmetric rudder and keel configurations. Whilst the estimate of performance for these yachts is based on plausible physics, there has been a deliberate policy not to reach a situation where these types of yachts are favored.

During 2012 the hydrodynamic resistance formulation underwent a significant revision. This resulted in deriving a new R_r formulation based only on BTR and LVR using a methodology to assess for each Froude number (F_n) the R_r variation related to a base boat having $LVR = BTR = 6$. The Length model was also been modified to more correctly represent a dynamic length.

Also the viscous resistance formulation was modified to more sensibly capture the appropriate reference length of contemporary canoe body shapes.

6.1 Viscous Resistance³¹

$$R_f = \frac{1}{2} \cdot \rho V^2 \cdot Area \cdot (C_f \cdot ff) \quad [82]$$

where

$$\begin{aligned} ff &= 1.05 \\ C_f &= 0.066/(\log_{10}(Re) - 2.03)^2 \\ Re &= V \cdot 0.85 \cdot LSM1 / \nu \end{aligned}$$

so for 2013 we changed the friction line (Hughes in way of ittc57), the form factor (1.05, it was 1.00), and the reference length (0.85LSM1 in way of 0.7LSM1).

6.1.1 Canoebody

The canoe body viscous drag R_{vc} is calculated using the following expression:

$$R_{vc} = q \cdot C_{f_c} \cdot WSA_c(\phi) \quad [83]$$

where:

$$\begin{aligned} C_{f_c} &= 0.066/(\log_{10}(Re) - 2.03)^2 \\ Rn &= V \cdot 0.85 \cdot LSM1 / \nu \\ WSA_c(\phi) &= \text{canoe body wetted surface at heel } \phi \text{ in still water} \\ q &= \text{“dynamic head”} = 0.5 \rho V^2 \end{aligned}$$

6.1.2 Appendages

The currently implemented scheme divides each appendage into 5 segments as shown in *Figure 27*, and determines the viscous coefficient of resistance of each strip based on the local (strip specific) Reynolds Number and thickness/chord (t/c) ratio.

³¹ Major Change 2013

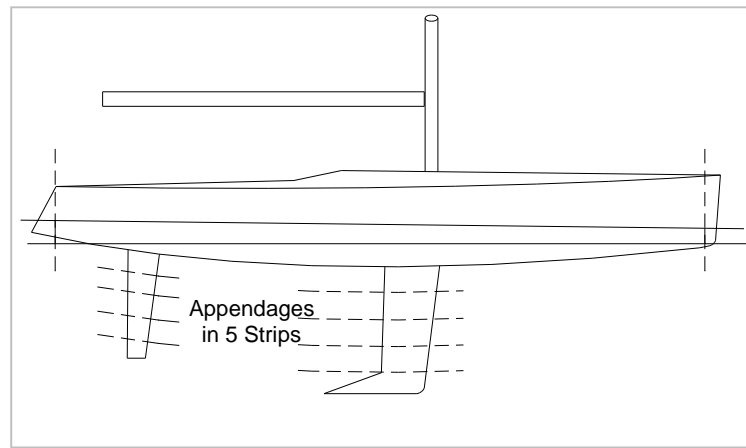

Figure 27 - Strip wise segmentation of appendages

The viscous resistance of each strip is then calculated from the product of the dynamic head, the local wetted surface area and an appropriate skin friction resistance coefficient (C_f). The determination of the appropriate C_f is based on data presented in Fluid Dynamic Drag (Hoerner 1965). The calculation³² is based on 4 Reynolds Number regimes, calculated for a flat plate and t/c ratios of 10 and 20%, as shown in Table 10.

Reynolds No.	1000* C_f Flat plate	1000* C_f $t/c = 0.1$	1000* C_f $t/c = 0.2$	Bulb
3.162E+03	24.85	42.07	44.12	59.29
1.00E+04	13.86	28.93	30.51	44.00
3.162E+04	7.73	20.20	21.42	32.66
1.00E+05	4.95	10.74	11.50	16.54
3.162E+05	3.46	4.99	5.40	6.51
1.00E+06	3.00	3.62	3.94	4.49
2.512E+06	3.00	3.62	3.94	4.49
6.310E+06	3.00	3.62	3.94	4.49
1.585E+07	2.81	3.39	3.69	4.21
5.012E+07	2.39	2.88	3.14	3.57
1.995E+08	1.96	2.36	2.59	2.93

Table 10 - Appendage C_f values used in the VPP

This approach works well for plain fin keels and rudders, but for keel bulbs which occupy the lowest appendage strip some further calculation must be done to ensure that appropriate characteristics are derived. The following approach is currently used:

- Use a chord length equal to the average of the top of the bottom strip and the longest fore and aft length occurring in the bottom strip
- Use a maximum thickness equal to: $\text{volume} / (\text{area} \times 0.66)$
- Use a reference area equal to the maximum of the strip projected area, and the wetted surface area.

The total viscous drag of the appendages is determined as follows:

$$R_{VA} = \frac{1}{2} \rho V^2 \left(\sum_{N=1}^{N=5} (A_{StripN} C_f(\text{rudder})_{StripN} + A_{StripN} C_f(\text{keel})_{StripN}) \right) + A_{centerboard} C_f_{centerboard} + A_{Canard} C_f_{Canard} \quad [84]$$

The total frictional resistance is the sum of the appendage and canoe body contribution.

$$D_{FRICITION} = R_{VC} + R_{VA} \quad [85]$$

³² Scheme devised by Karl Kirkman, Dave Greeley and Jim Teeters

6.1.2.1 Double rudders (2010)

The Offset file has now been configured to accept double rudder configurations as detailed in Appendix A. The viscous drag is calculated according to *Table 10*, with no velocity deficit for the keel wake. The immersed wetted area is calculated at each heel angle assuming an undisturbed static waterplane.

6.1.2.2 Centreboards

Because centerboards are often not as well refined as keel fins a different drag formulation³³ is adopted:

$$\text{Centerboard_drag} = 0.006 \cdot \frac{1}{2} \cdot \rho V^2 \cdot A_{cb} \quad [86]$$

$$\text{Wetted_Area_Centerboard}_{(A_{cb})} = 2 \cdot ECM \cdot \frac{CBTC + 2 \cdot CBMC + CBRC}{44} \quad [87]$$

where:

- ρ = Water density
- ECM = Centre board extension
- CBTC = Centerboard tip chord
- CBMC = Centerboard mid chord
- CBRC = Centerboard root chord

If there is no data for centerboard chord then the following formula is applied.

$$\text{Wetted_Area_Centerboard}_{(A_{cb})} = 2 \cdot 0.6 \cdot ECM^2 \quad [88]$$

6.1.2.3 Dagger Boards, Bilge Boards

Bilge boards and dagger boards are treated as per *Table 10* based on their area and mean chord length.

6.1.2.4 Trim Tabs

The use of a trim tab to reduce the viscous drag of the keel fin by shifting the viscous “drag bucket” to higher lift coefficient is reflected in a formula that reduces the viscous drag coefficient for a keel with a trim tab³⁴.

$$\text{Lift_Coefficient_Cl} = 0.75 \cdot \frac{\text{Sideforce}}{q \cdot A} \quad [89]$$

$$\text{Drag_Coefficient_Cd} = 0.0097 \cdot Cl^2 + 0.00029 \cdot Cl + 0.0034 \quad [90]$$

$$\text{Cd_diff} = 0.33 \cdot (Cd - 0.0034) \quad [91]$$

Where A is the keel area and q is the dynamic head $0.5 \rho V^2$.

Cd_diff is subtracted from the keel strip friction drag coefficient.

³³ 1987 ERFXNEW.FOR, MODLDIM2.FOR

³⁴ The form of the code reflects that the drag reduction has been reduced over time because the original formulation was regarded as too punitive in terms of handicap.

6.2 Propeller

The drag of the propeller is calculated as follows:

$$D_{PROP} = \frac{1}{2} \rho V_s^2 \cdot 0.81 \cdot PIPA \quad [92]$$

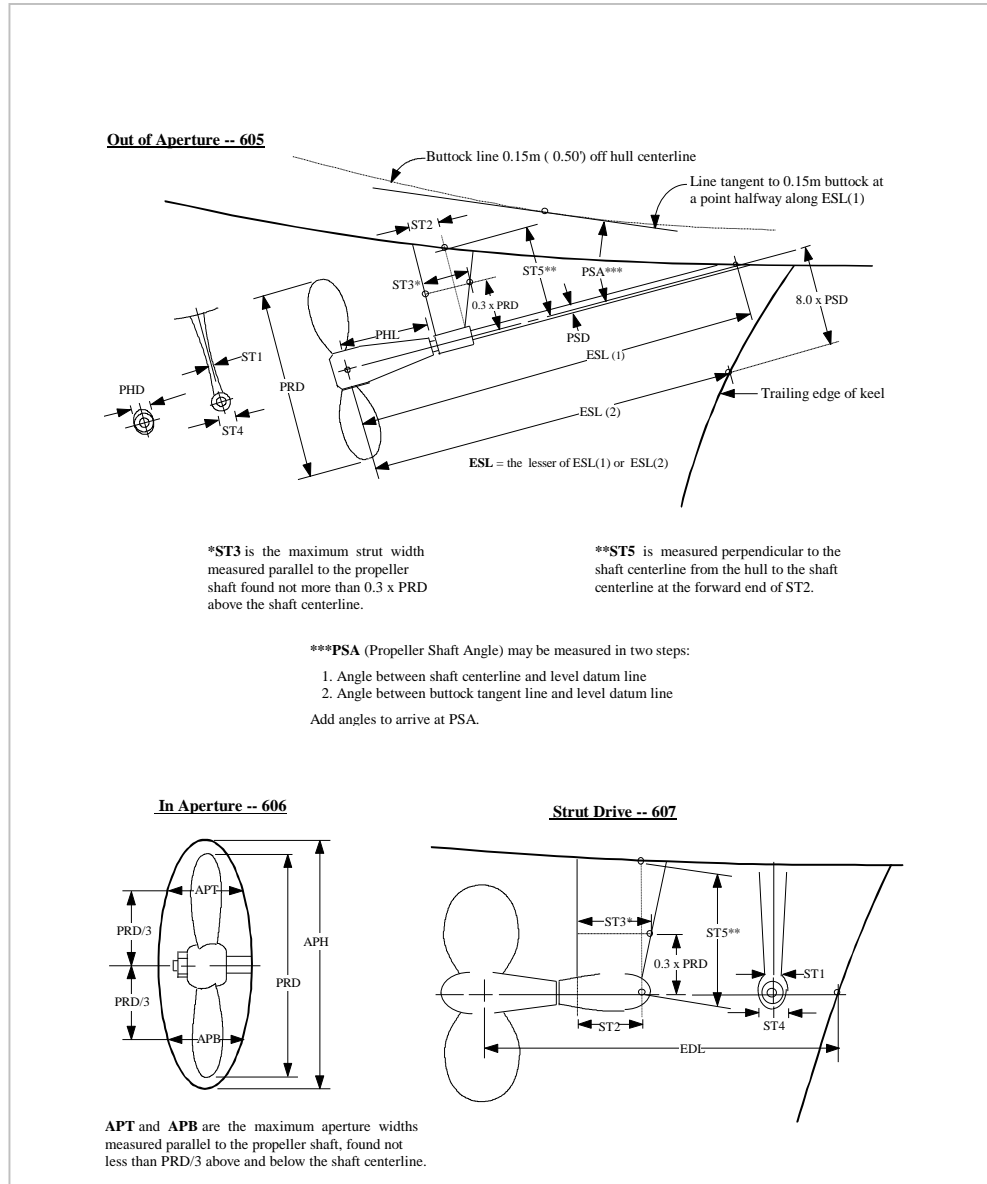

[93]

Figure 28 - Propeller Installation Dimensions

PIPA is calculated according to the following formulae which depend on the type of installation.

6.2.1 Shaft installation

For all propellers with shaft installation, IPA is calculated as follows:

$$IPA = (0.04 + \sin(PSA))^3 \cdot (PSD \cdot (ESL - ST2 - PHL) + ST4 \cdot (ST2 + PHL)) + 0.03 \cdot ST1 \cdot \left(ST5 - \frac{ST4}{2} \right) \quad [94]$$

**6.2.1.1 Folding and feathering 2 blade**

$$PIPA = IPA + 0.65 \cdot (0.9 \cdot PHD)^2 \quad [95]$$

For a folding propeller PHD shall not be taken greater than 3.5xPSD in the above formula.

6.2.1.2 Folding and feathering 3 blade

$$PIPA = IPA + 0.70 \cdot (0.9 \cdot PHD)^2 \quad [96]$$

For a feathering propeller PHD shall not be taken greater than 4.0*PSD in the above formula.

6.2.1.3 Solid 2 blade

$$PIPA = IPA + 0.10 \cdot PRD^2 \quad [97]$$

6.2.1.4 Solid 3 and more blades

$$PIPA = IPA + 0.12 \cdot PRD^2 \quad [98]$$

If ESL is less than PRD, PIPA shall be multiplied by 0.5.

6.2.2 Strut drive

PIPA shall be determined as follows:

6.2.2.1 Folding and feathering 2 blade

$$PIPA = 0.06 \cdot ST1 \cdot (ST5 - 0.5 \cdot ST4) + 0.4 \cdot (0.8 \cdot ST4)^2 \quad [99]$$

6.2.2.2 Folding and Feathering 3 Blade

$$PIPA = 0.06 \cdot ST1 \cdot (ST5 - 0.5 \cdot ST4) + 0.42 \cdot (0.8 \cdot ST4)^2 \quad [100]$$

6.2.2.3 Solid 2 Blade

$$PIPA = 0.06 \cdot ST1 \cdot (ST5 - 0.5 \cdot ST4) + 0.10 \cdot PRD^2 \quad [101]$$

6.2.2.4 Solid 3+ Blades

$$PIPA = 0.06 \cdot ST1 \cdot (ST5 - 0.5 \cdot ST4) + 0.12 \cdot PRD^2 \quad [102]$$

Notes:

1. For any strut drive, if EDL is less than 1.5 * PRD, PIPA shall be multiplied by 0.5.
2. The shape of the strut may be modified, but the full functionality of the standard model must be retained and ST1-ST4 values may not be reduced below the unmodified standard dimensions. For handicapping purposes ST1-ST4 shall not be taken bigger than the unmodified standard dimensions.
3. ST4 shall be measured at the aft end of the hub instead of at the point of maximum projected area, better representing the flow separation drag.
4. An upper ST4 limit will be used for the PIPA. This limit depends on the L of the yacht. The maximum is defined by a curve of values just above those typical of most common production units, faired over an ample length range. The upper limit for ST4 is thus defined as the lesser of:

$$(4 \cdot 10^{-5} \cdot L^3 - 0.0011 \cdot L^2 + 0.015 \cdot L + 0.05) \text{ or } 0.2 \text{ (but never less than 0.1)} \quad [103]$$

6.2.3 In an aperture

For propellers of any type installed in an aperture PIPA shall be taken as the least of the values determined by the formulae:

$$PIPA = 0.07 \cdot PRD^2 \quad [104]$$

$$PIPA = 0.07 \cdot \left(\frac{APT}{4} \right)^2 \quad [105]$$

$$PIPA = 0.07 \cdot \left(\frac{APH}{1.125} \right)^2 \quad [106]$$

$$PIPA = 0.07 \cdot \left(\frac{APB}{4} \right)^2 \quad [107]$$

6.2.4 Tractor propellers

For tractor propellers of any type installed out of aperture PIPA shall be zero.

6.2.5 Twin screws

IMS has an input to signify twin propeller installations. If this is indicated, PIPA is doubled for any type of installation or propeller.

6.3 Residuary Resistance³⁵

The calculation of the wave-making or residuary resistance is based on the calculation of a residuary resistance coefficient at preset values of Froude Number (Fn). The Fn is a non-dimensional speed based on the yacht's Dynamic Length L_{Dyn}

$$F_n = \frac{V}{\sqrt{g \cdot L_{Dyn}}} \quad [108]$$

The hull is the main element of the residuary resistance, with a small contribution from the appendages.

Recognizing that previous attempts to accurately calculate the effect of several hull parameters such as Prismatic Coefficient, Longitudinal Center of Buoyancy (LCB) and water plane area coefficient have led to undesirable type-formed hull shapes and that this trend could not be addressed within the existing model, it was decided to simplify the input parameters accounting for 2 main parameters only: dynamic Length-Volume ratio (LVR), and Beam to Canoe-body-draft ratio (BTR) to avoid as much as possible any type-forming. The effects of hull volume distribution are still captured by the use of the traditional integrated lengths.

6.3.1 Resistance Surfaces

The R_r drag curve for the canoe body is formed by the extraction of drag values at 24 Froude numbers (Fn) from surfaces of BTR and dynamic LVR and ranging from Fn 0.125 up to Fn 0.7.

The Froude number used also incorporates dynamic length. For speeds outside this range the resistance is extrapolated. The BTR and LVR ranges of the surface are 2.5 to 9 and 3 to 9 respectively and outside this range the value defaults to that of the closest point of the surface.

The LVR-BTR surfaces are very similar to the example plots below and the points from which they are derived can be downloaded in .CSV file format from www.orc.org/rules.

³⁵ Major Revision 2013

The CSV file is a tabulation of the coordinates of the surfaces interrogated by the VPP as it calculates the Residuary Resistance per unit of displacement.

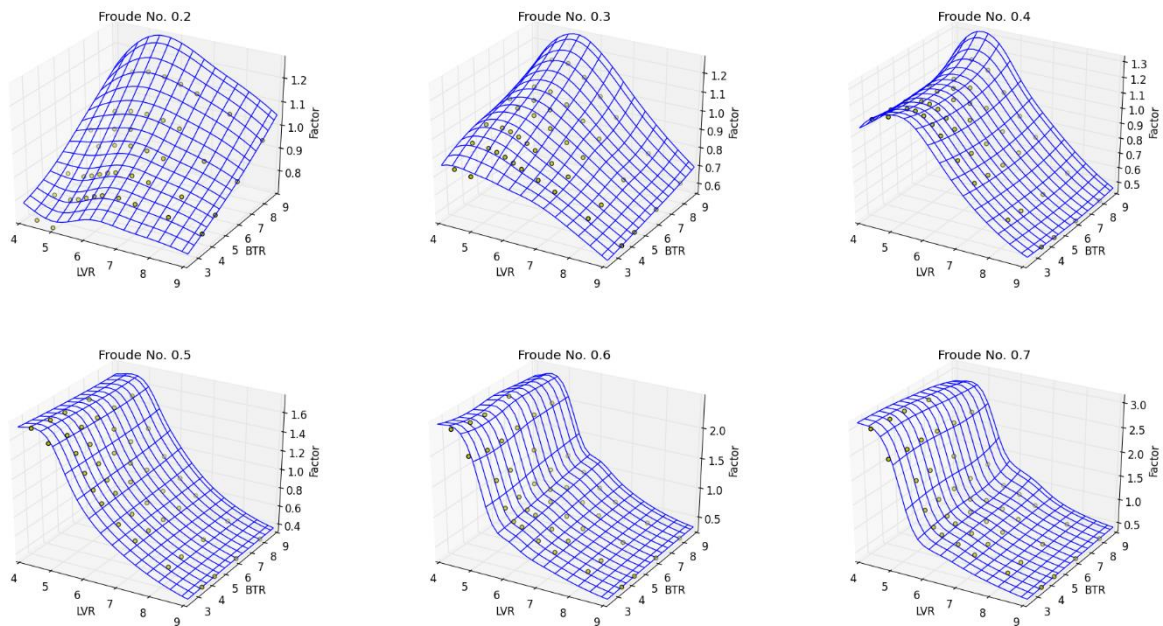

Figure 29 - Typical Rr multiplier at fixed Froude Number

In 2014 fine tuning of RR surfaces was made in areas not very well defined (low LVR, high Fn)

6.3.2 Composite Length Calculation

Up until 2013 2 LSM³⁶ length values were compounded into a single “L” value used as the reference waterline length to calculate Froude Number. In the 2013 VPP, LSM1 was retained, and two new sunk length values were created, LSM4 and LSM6 which are used only in the determination of residuary resistance. To help with the coding nomenclature the LSM terms used in the calculation of residuary resistance were given the pre-fix RR, i.e. RRLSM1³⁷, RRLSM4 and RRLSM6. The height of RRLSM4 is aimed to match wave heights at Fn 0.4, while the height of RRLSM6 is designed to match waves heights at Fn 0.3, and both depend on suitable functions of the yachts length and LVR. RRLSM6 has a lower length exponent than RRLSM4, because at Fn < 0.35 having a lot of volume in the ends rather than in the middle is not as beneficial as it is at Fn > 0.35. The static sailing waterplane length RRLSM1 has also had its exponent reduced to 0.3 to reflect that it is now only primarily used at slow speeds.

RRLSM Flotation Planes

RRLSM	Exponent equation [Error! eference source not found.]	Height above Sailing Waterplane	
		Fwd	Aft
RRLSM1	0.3	0	0
RRLSM4	0.4	$RRLSM1 * 0.093 * LVR^{-1.2}$	$RRLSM1 * 0.14 * LVR^{-1.2}$
RRLSM6	0.45	$RRLSM1 * 0.736 * LVR^{-2.15}$	$RRLSM1 * 1.105 * LVR^{-2.15}$

³⁶ LSM: Length Second Moment-see equation 12.

³⁷ LSM1 = RRLSM1

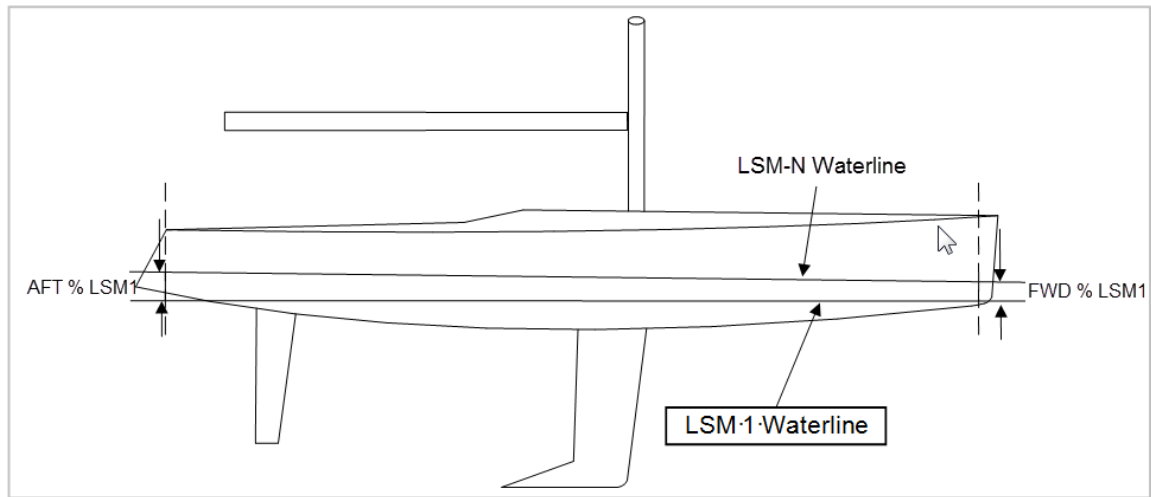

Figure 30 – Floatation Planes

Recognising that the wave height, the dynamic heave and therefore the physical length itself are highly sensitive to both Froude number and Length volume ratio (LVR), a new scheme was developed to improve the treatment of "effective length." Two new sunk length values were created, namely RRLSM4 and RRLSM6, aimed at $F_n > 0.35$ and $F_n < 0.35$ respectively. The height of RRLSM4 is aimed to match wave heights at $F_n 0.4$, while the height of RRLSM6 is designed to match waves heights at $F_n 0.3$, and both depend on suitable functions of the yachts length and LVR. RRLSM6 has a lower length exponent than RRLSM4, because at $F_n < 0.35$ having a lot of volume in the ends rather than in the middle is not as beneficial as it is at $F_n > 0.35$. The static sailing waterplane length RRLSM1 has also had its exponent reduced to reflect that it is now only primarily used at slow speeds. The new L is dependent on Froude number, and based on length mixtures which are linearly interpolated in four phases:

- Phase 1: $0.125 < F_n < 0.3$ L is a mixture of RRLSM1 and RRLSM6, starting at 100% RRLSM1 and finishing at $F_n 0.3$ as 100% RRLSM6
- Phase 2: $0.3 < F_n < 0.4$ L is a mixture of RRLSM6 and RRLSM4, starting as 100% RRLSM6 and finishing as 100% L
- Phase 3: $0.4 < F_n < 0.5$ L is a mixture of RRLSM4 and RRLSM1, starting at 100% RRLSM4 and ending as 70% RRLSM4
- Phase 4: $0.5 < F_n$ L is a mixture of RRLSM4 and RRLSM1, continuing as 70% RRLSM4

For values of $F_n > 0.4$ the RRLSM6 loses relevance, but the wave length grows longer than the hull as the F_n continues to increase, resulting in a reduction of the wave height locally at the transom, so RRLSM1 is mixed in to reduce the effective length appropriately, representing a 30% share of L by $F_n 0.5$ and then continuing at that ratio for higher Froude numbers.

Froude No	0.125	0.2	0.25	0.3	0.35	0.4	0.45	0.5	0.6	0.7
RRLSM 1	1	0.6	0.3	0	0	0	0.15	0.3	0.3	0.3
RRLSM 4	0	0	0	0	0.5	1	0.85	0.7	0.7	0.7
RRLSM 6	0	0.4	0.7	1	0.5	0	0	0	0	0
Sum	1	1	1	1	1	1	1	1	1	1

Table 11 – L calculation scheme

6.4 Drag due to heel

A new formulation of the heeled drag is included in the new hydro model based on calculation of heeled viscous and residuary resistance components using the same parameters (Wetted Area, BTR and LVR) but calculated with the boat heeled.

6.4.1 Induced Drag³⁸

This formulation also takes into account the asymmetry of the heeled hull form, and then considers appendages size (and special configurations like canards and trim tabs) so that leeway angle can be calculated and used to compute the induced drag. The methodology implemented is as follows:

- Formulate lift area (Coefficient of lift multiplied by projected area, abbreviated as "Cl_a") versus leeway angle slopes and axis intercepts for the hull and for the combined appendages, based on simplified lifting line theory for the hull plus a modified version of the lift efficiency modified by BTR and LVR method already in place in the VPP for the appendages;
- Determine from the LPP a hull yaw angle at zero leeway due to the asymmetry of the heeled hull shape. This is based on the transverse shift of the center of buoyancy in the forward and aft end of the hull;
- Combine both hull and appendage lift Coefficient (Cl) vs Leeway lines to create a total coefficient of lift area line (tcl_a) which considers areas and initial slopes (for canard or trim tab yachts, the hull share of lift is assumed to be zero).

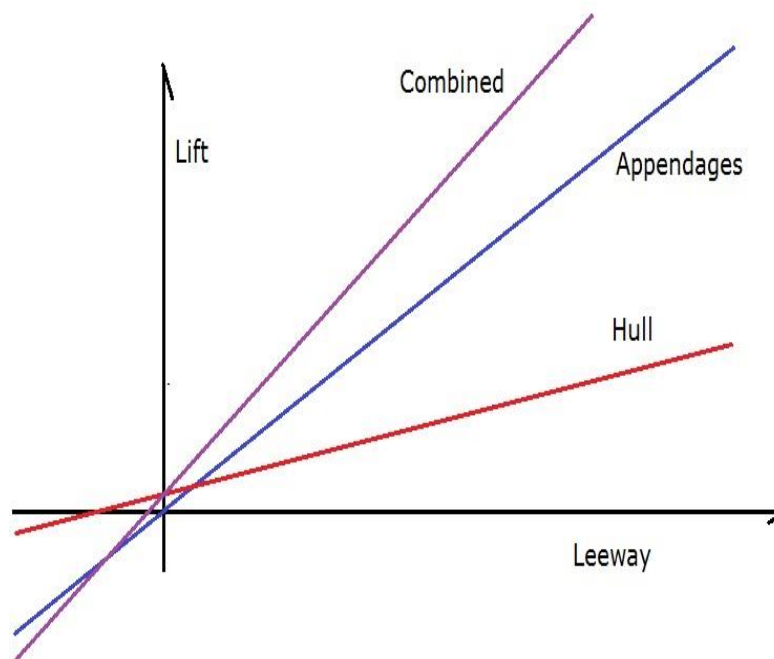

Figure 31 – Induced drag

In the VPP solver operation the procedure is to:

- Divide applied side force by $0.5 \cdot \text{density} \cdot V_s^2$ to obtain the required tcl_a;
- determine leeway at the applied tcl_a;
- determine separate hull and appendage lift shares at the leeway angle obtained;
- From effective spans of hull and appendages, determine the induced drags of both hull and appendages; Using the effective hull draft, and the MHSD respectively as the (Effective Draft) value in equation [109].

³⁸ Major changes 2013

$$Drag_{induced} = \frac{F_H^2}{r \cdot t \cdot V^2 \cdot (Effective _ Draft)} \quad [109]$$

where:

F_H = Heeling Force

- D_i total = D_i appendages + D_i hull, with both D_i component parts accounted as

The programmed structure of this method has allowed for the factors to be tuned to match closely the CFD and tank data, and then checked against the existing fleet.

TERM	Description	Conventional	Canting Keel	Canting Keel + CL canard / dagger board	Canting Keel & twin daggerboards
Wave Trough	Wave Trough Keel Root emergence	1.0	1.0	0.5	0.0
Hull Assymetry	Hull assym angle used in canoe body lift	Yes	Yes	Yes	Set to zero regardless of calculated hull assym angle
MHSD	Effective draft Calculation	MHSD	Use keel projected area on hull centreplane for lift calculation	Use keel projected area on hull centreplane for lift calculation, or max draft of canard.	Use maximum achievable draft , And use daggerboard area for lift calculation, and projected area for canted keel
FunSteady	FunSteady	1.0	Should always be in credit, cut off is MHSD = 19% Length	Should always be in credit, cut off is MHSD = 19% Length	Should always be in credit, cut off is MHSD = 19% Length

When a boat has a canting keel plus daggerboards, the transverse inclination of the daggerboard is properly accounted for the calculation of effective draft at all heel angles. Taking into account the heel angle φ , the longitudinal and transverse position of the canard (c_xoff and c_yoff respectively), the shape of the boat section at the canard root, the canard span and its angle c_angle to the longitudinal centerplane, angle, the draft of the canard when the boat is heeled is determined as:

$$tr \max_c = t_c_r + c_span \cdot \cos(c_angle - \varphi)$$

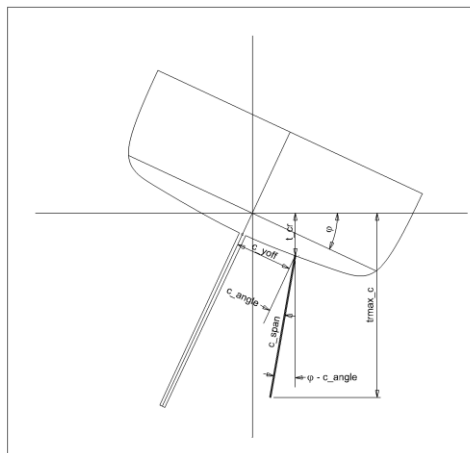

This draft is compared to the keel effective draft, and the maximum is taken for the sake of induced drag calculation.

6.4.1.1 Unsteady Effects

A final modification to the effective draft formula was subsequently adopted to address a trend towards deeper and deeper keels on racing yachts. This trend arose because of the nature of fleet racing in yachts of similar performance: it was found that extra draft, even though the VPP predicted higher speeds, was beneficial in being able to achieve and maintain a place in the front rank of the race to the windward mark. Also on windward/leeward races which, by definition, involve a lot of tacking the deep draft keel proved to be more competitive in the “down speed” condition coming out of tacks. Equation [110] shows that if heel angle, and therefore heeling force, are constant the induced drag is inversely proportional to speed². Thus the effect of keel draft is handicapped only for the induced drag at “full speed”, whilst in a race with a lot of tacking some note should be taken of the additional induced drag occurring when sailing at lower speed.

This effect is taken into account by the use of an “unsteady factor” (FUNSTEADY). The “unsteady factor” is based on a mean IMSD/length ratio of 0.19, at shallower draft than this FUNSTEADY is reduced, at deeper draft FUNSTEADY is increased. This is purely a type-forming modification to the VPP. The final equation for induced drag is shown in equation [110]. The function in speed and heel angle $fn(\phi V_s)$ is that shown in Figure 31.

$$D_i = \frac{F_H^2}{MHSD^2 \cdot \pi \cdot \rho \cdot V^2 \cdot FUNSTEADY^2 \cdot [fn(\phi V_s)]^2} \quad [110]$$

$$FUNSTEADY = 0.95 + \left(\frac{T_R}{L} - 0.19 \right) \quad [111]$$

6.4.1.2 Froude Number Effects

If the yacht sailed in a homogeneous fluid then the above equation would be a satisfactory description of the induced drag. However in practice both speed and heel angle affect the value of effective draft. As the yacht sails faster the mid-ship wave trough deepens, and as the yacht heels the root of the keel and rudder move closer to the free surface. Both of these effects allow the pressures on the keel and rudder to produce surface waves, or in the worst case ventilation, particularly at the rudder root. These effects mean that the water surface acts less and less as a reflection plane as speed and heel angle increase. In order to account for these effects a speed and heel angle correction to the upright, zero speed effective draft was adopted³⁹. The form of the correction for two hulls with BTR = 4 and 2 are shown in Figure 32. The figure shows how the deleterious effects of speed and heel angle on induced drag are reduced as beam to draft ratio is reduced. Once again, like the heel drag factor it is a plausible and appropriately sensitive representation of a complex physical phenomenon.

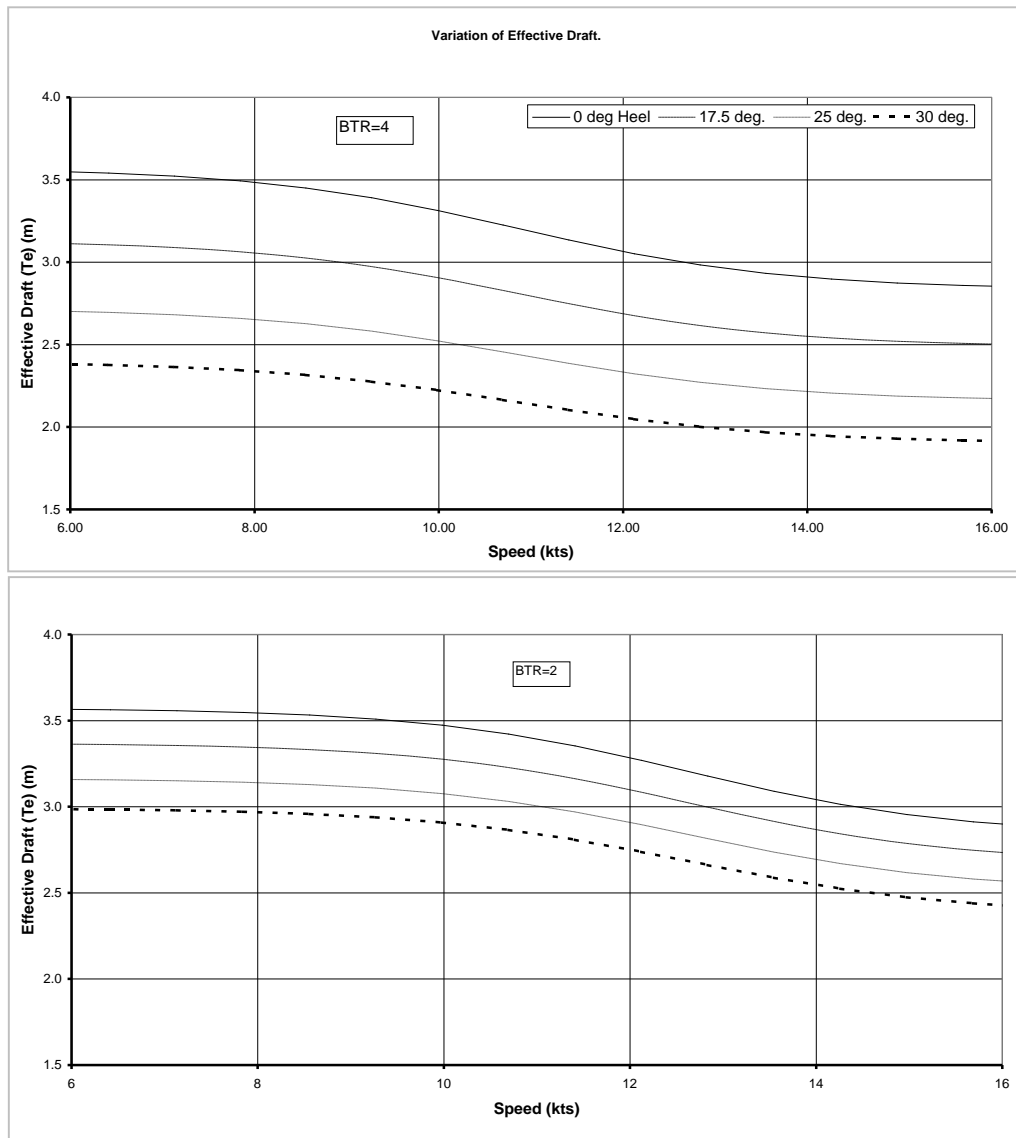

Figure 32 - Variation of effective draft with speed and heel angle
(Upper BTR = 4; Lower BTR =2)

6.4.1.3 Immersed transom

The following section describes a generic wave height calculation procedure for assessing the immersed transom areas as a function of Froude Number and the calculation of the drag due to the immersed transom. The height of the wave at the end of the static WL was found from the wave elevation observations of 13 non appended models of the Delft Systematic Series to be approximately

$$WH_{WLend} = a1 \cdot \frac{VLR_{mult}}{10} \cdot LSM1 \cdot c_{vtr}^5 \quad [112]$$

where

$$VLR_{mult} = 2.1 \cdot \frac{\sqrt[3]{VOLc}}{LSM1 \cdot c^{1.5}} \quad [113]$$

$$a1 = 1.233 \cdot \log(Fn) + 1.985 \quad [114]$$

Two different stern flow conditions are considered.

- a) In the case of the flow separation from the profile of the overhang the wave height at the transom with an standard overhang length of $0.135 \times \text{LSM1c}$ is calculated by linear interpolation from the wave height at the end of the static waterline WH_{WLEnd} and the point of separation which is defined as the non-dimensional length $a2$

$$WH_{stdOverhLength} = WH_{WLEnd} \cdot \left(1 - \frac{1}{a2}\right) \quad [115]$$

where

$$a2 = \text{Min}\left(56 \cdot (Fn(L) - 0.20)^{1.75} \cdot \text{Overh}_{separPr(Fn=0.3)}, 1.0\right) \quad [116]$$

$$\text{Overh}_{separPr(Fn=0.3)} = 0.30 + \left(\frac{0.115}{VLR_{mult}}\right)^4 \quad [117]$$

being the overhang separation point at $Fn=0.3$

- b) In the case of transom flow separation, which occurs when $a2$ is becoming 1 or greater, the wave height at the transom with an standard overhang length of $.135 \cdot \text{LSM1c}$ is calculated as

$$WH_{stdOverhLength} = WH_{WLEnd} \cdot a3 \cdot a4(i + x) \quad [118]$$

$$x = 0 \dots 3$$

with

$$a3 = \frac{(1.1 - Fn)}{0.975} \quad [119]$$

and with $a4$ being a degradation factor with increasing Fn 's and (i) denoting the Fn -index at which $a2$ becomes 1

$$a4(i) = 0.25$$

$$a4(i + 1) = 0.5$$

$$a4(i + 2) = 0.75$$

$$a4(i + 3) = 1$$

The wave height at the real transom is again calculated by linear interpolation as

$$WH_{stern} = dWH \cdot \left(\frac{0.15 \cdot \text{LSM1c} - \text{Overhang}}{0.15 \cdot \text{LSM1c}}\right) + WH_{stdOverhLength} - \text{Min}(z_{tran}, 0) \quad [120]$$

with

$$dWH = WH_{WLEnd} - WH_{stdOverhLength} \quad [121]$$

$$\text{Overhang} = \text{LSM5c} - \text{LSM1c} \quad [122]$$

LSM5c being the LSM of the boat sunk to the lowest point of the transom, if above WL .
2011 The wave height at the transom is reduced by the trim effect of shifting the crew 10% LSM 1 forward⁴⁰.

In 2012 the transom height (above or below the waterline) used for the calculation of the immersed transom drag has been modified taking into account the possibility of moving the crew toward the bow for minimizing it.

⁴⁰ This was done to discourage the adoption of extreme stern down trim

This is done by an iterative process: first the immersed transom drag is calculated, and evaluated at $Fn=0.350$. If there is any transom drag at that velocity, the transom height above the waterline is increased by an amount corresponding to a crew shift forward of $0.01L$. Then the check is performed again. If there is still a non zero drag, the transom height is increased again by the same amount. The process continues up to a maximum shift of the crew toward the bow of $0.15L$. At that stage, any nonzero immersed transom drag is considered the most reliable estimate of this resistance component.

The immersed transom area is the area below a horizontal plane of the height $WH_{aboveWL}$

$$WH_{aboveWL} = WH_{stern} + H_{Trprof} \quad [123]$$

with

H_{Trprof} being the intersection of the transom and the regression line from the profile points of the afterbody of the hull.

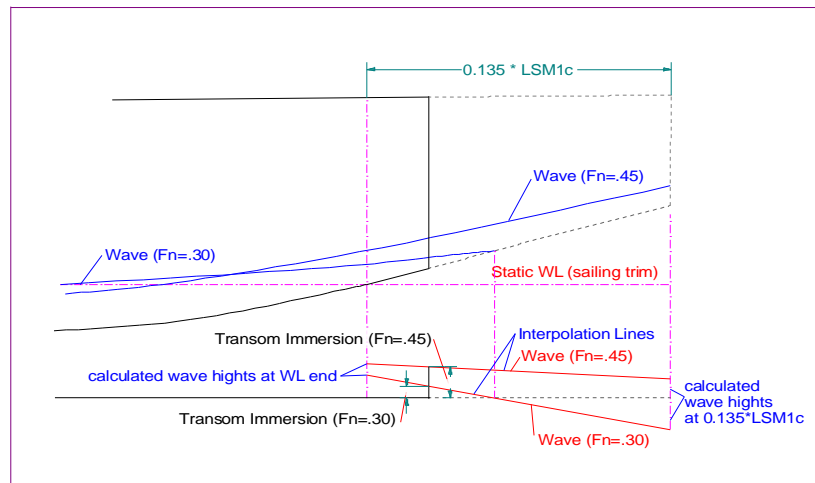

Figure 33 - Principle of estimating transom immersion

The viscous drag component due to an immersed transom is calculated by means of Hoerner's formula for the base drag of a fuselage with a truncated tail end.

$$Cd_{hull} = 0.029 \cdot \frac{(ATR - AMS1c)^{1.5}}{Cd_{hull}} \quad [124]$$

where

- R = the immersed transom area as calculated by the above outlined procedure
- AMS1c = the midship section area in sailing trim
- $Cd_{hull} = Rf_{hull} / (\rho/2 * v^2 * AMS1c)$
- Rf_{hull} = the frictional resistance of the canoe body

6.4.1.4 Appendages

The original Delft Series models had all been tested with a standard keel and rudder and consequently the original MHS approach was to include the appendages as part of the total displacement for the purposes of calculating residuary resistance. On yachts with hull forms where the appendage/canoe body interface was less than well defined this worked satisfactorily. Over time however a more sophisticated treatment was sought, and now all of the DSYHS models have been tested as bare canoe bodies. An algorithm for appendage residuary resistance that is sensitive to both keel volume and depth was derived⁴¹. The residuary resistance of an element of keel or bulb is based on 2 baseline curves

⁴¹ Jim Teeters US Sailing

shown in *Figure 34*. These show the resistance per unit volume normalized against F_n^2 for an element of keel fin or bulb at the standard depth, $0.1L$ and $0.2L$ respectively.

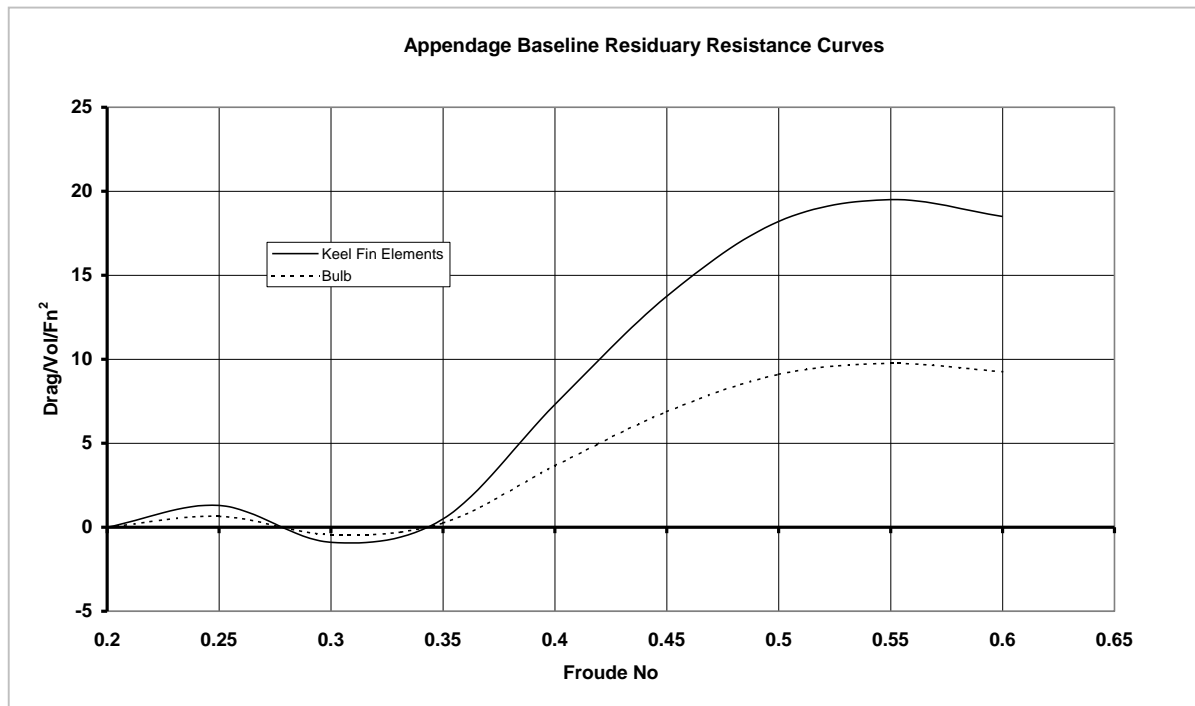

Figure 34 - Appendage residuary resistance per unit volume at standard depth

As described in section 8.1.2, the VPP divides the keel into 5 fore and aft strips, stacked on top of each other. The volume and average depth of each strip is calculated. The major factors that influence the wave-making drag of an appendage “strip” are:

- 1) Appendage strip volume
- 2) Appendage strip depth below the free surface
- 3) Boat speed
- 4) Whether or not that piece of volume is a bulb or part of the vertical foil

Bulbs are more three-dimensional in nature, apparently cause less disturbance to the water flow, and have less drag per unit volume. The drag of bulbs per unit volume is approximately half that of keel strips. The attenuation of drag with depth is approximately linear for both keel strips and bulbs.

Currently, the VPP looks for bulbs only in the deepest strip of a keel. The test criterion is the ratio of the chord length of that deepest strip to the chord length of the strip above it. If that chord ratio is ≥ 1.5 , then the deepest strip is considered to be a bulb. If the ratio ≤ 1.0 , the strip is a keel strip. If the ratio is between 1.0 and 1.5, the drag is found by linear interpolation over chord ratio of the two drags found by treating the strip as a bulb and as a keel.

Where the upper keel strip is determined to be greater than 1.5 x the average of strips 2,3, & 4 then the residuary resistance of the strip is calculated using the “Bulb” residuary resistance line⁴². For traditional style hulls where the keel chord exceeds 50% of LSM1 then the keel volume is added to the canoe body volume for the purposes of calculating the residuary resistance.

In 2011 the RR of keels having long chords has been further reduced: a reduction factor is applied to the drag of each keel strip, proportional the ratio of the chord of the strip to LSM1. Full drag is given for keels having chords smaller than $0.05 \cdot LSM1$. Then a linear reduction from $c=0.05 \cdot LSM1$ to $c=0.15 \cdot LSM1$ is enforced. For chords larger than $0.15 \cdot LSM1$ it is assumed that the RR of that strip is negligible.

⁴² 2011 To address the use of high volume keel strakes

$$D_{RESIDUARY} = Rr_{Canoe} + Rr_{Appendage} \quad [125]$$

6.4.2 Rail-under drag

Rail-under drag is not intended to calculate the drag of immersing the lee rail, it is an artifice intended to prevent the VPP finding equilibrium sailing conditions at high heel angles. Rail-under drag is zero up to a heel angle of 30 degrees. Above this value the upright residuary resistance is multiplied by a factor and added to the total drag.

$$DRU = 0.0004 \cdot D_{RESIDUARY} \cdot (\phi - 30)^2 \quad [126]$$

6.5 Added Resistance in Waves, R_{AW}

The addition of an added resistance in waves (R_{AW}) module to the VPP⁴³ was brought about by the fact that cruising yachts, with outfitted interiors, were disadvantaged relative to their “stripped out” racing rivals. This is not surprising, since reducing the yacht’s moment of inertia by concentrating weight close to the centre of gravity will yield a performance gain when sailing in waves. The US Sailing funded project to introduce this feature into the VPP had three aims which tackled the fundamentals of predicting R_{AW} :

- 1) Define a sea spectrum (wave energy density function) appropriate to the sailing venue
- 2) Devise a plausible and appropriately sensitive physical model of how parametric changes to the yacht affect R_{AW} when sailing in the sea state defined in 1
- 3) Devise a method by which a yacht’s pitch inertia could be determined directly by a physical test, in the same way that stability is measured by an inclining test.

6.5.1 Wave Climate

As part of the research prior to introducing the R_{AW} module, US Sailing funded the deployment of a wave height measuring buoy at several popular sailing venues. The buoy was deployed during typical races and the water surface elevations were recorded together with the wind speed. On the basis of these measurements a single definition of wave climate was derived in the form of a wave energy spectrum normalised for a true wind speed of one knot. This approach has the merit that it is relatively easy to apply, because, whilst the significant height becomes a function of wind speed the modal period remains fixed at 5 seconds.

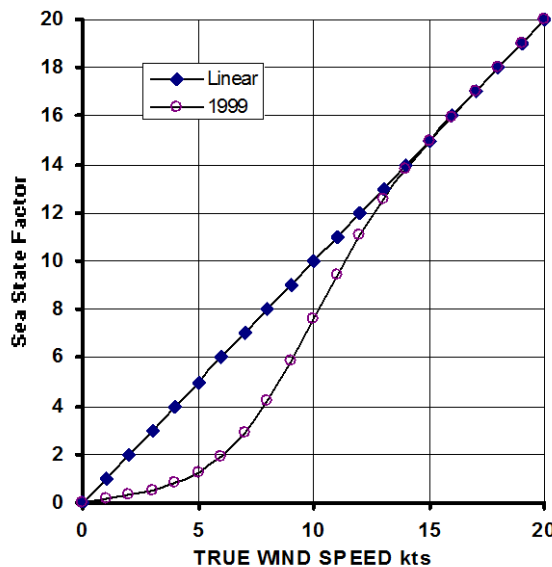

Figure 35 - Wave energy as a function of True Wind Velocity

⁴³ 1990

When this experimentally-derived linear variation of wave energy with wind speed was implemented it was found that the magnitudes of RAW were too high. Added resistance effects were seen to be dominating handicaps in 6 to 8 knots of wind when the sailors could see that no waves were present on the race course. In order to correct this, a “bubble” (or more correctly a dimple) was put in the curve that defined the wave energy as a function of wind speed.

Figure 35 shows the original linear sea-state factor together with the further reduction in the light wind wave energy agreed at the 1998 annual meeting. The formulation is shown in equation [127].

$$f(V_T) = V_T \cdot \left(-0.8375 \cdot \left(1.175^{(-0.00248V_T^{3.5})} \right) \right) \quad [127]$$

The $f(V_T)$ function is shown in Figure 35.

6.5.2 Determination of added resistance response

Equation [128] shows how the added resistance is calculated from the product of the wave energy spectrum and the R_{AW} RAO. The wave spectrum in each wind speed is defined by a constant times $f(VT)$. The task facing the handicappers was to produce RAO values for parametric variations of sailing yacht hull forms.

$$\overline{R_{AW}} = 2 \cdot \int_0^{\infty} \frac{R_{AW}}{\zeta_a^2} \cdot S_{\xi}(\omega) d\omega \quad [128]$$

Equation [129] shows the formulation⁴⁴ and the baseline parametric values are shown in Table 12.

$$R_{AW} = 2 \cdot \rho \cdot g \cdot L \cdot f(V_T) \cdot 0.55 \cdot f(\beta_T) \cdot f(L_{40}) \cdot \left(0.00146 + f(F_n) + f(K_{YY}) + f\left(\frac{L}{B}\right) + f\left(\frac{B}{T}\right) + f(LCB - F) \right) \quad [129]$$

where:

$$f(F_n) = 0.00191 \cdot (F_n - 0.325) \quad [130]$$

$$f(k_{YY}) = 0.01575 \cdot (GYR - 0.25) \quad [1301]$$

$$f\left(\frac{L}{B}\right) = \frac{5.23^{-L/B} - 5.23^{-3.327}}{8.494} \quad [132]$$

$$f\left(\frac{B}{T}\right) = 0.000166 \cdot \left(\frac{B}{T_C} - 4.443 \right) \quad [133]$$

$$f(LCB - F) = 0.01150 \cdot ((LCB - LCF) - (-0.03)) + 0.05780 \cdot ((LCB - LCF)^2 - (-0.03)^2) \quad [134]$$

$$f(L_{40}) = 0.5059 \cdot \log\left(\frac{L}{40}\right) + 1 \quad [135]$$

$$f(\beta_T) = \frac{\cos(\beta_T)}{\cos(40)} \quad [136]$$

⁴⁴ 1999

PARAMETER	SERIES RANGE	BASE VALUE
GYR	0.2-0.32	0.25
L/B	2.77-4.16	3.327
L3/√	103-156	125
LCB	0.50-0.56	0.53
LCF	0.54-0.60	0.57
B/TC	--	4.443
LCB-LCF	--	-0.03
Fn	--	0.325

Table 12 - Added Resistance in Waves; parametric limits and base values

In equation [129] the f_s factor provides a means to adjust the added resistance values and perhaps can be thought of as a sea energy or strength coefficient. A value of 0.64 is used.

The 0.55 factor represents the wave direction function, necessary because the R_{AW} calculations for the series were done in head seas, but yachts sail at approximately 45 degrees to the prevailing wind and sea direction.

The $f(\beta_T)$ function makes the added resistance a cosine function of heading with 40 degrees true wind (wave) heading as the basis.

The remaining functions in equation [129] take the difference between the boat and the base boat and then evaluate the increase or decrease in R_{AW} . The calculation of R_{AW} is done using the physical parameters (L, B, T_C) appropriate to the sailing heel angle.

6.5.2.1 Determination of Pitch Radius of Gyration (K_{yy})

The third element of the added resistance calculation is the determination of the pitch inertia of the yachts hull and rigging.

A yachts base radius of gyration is calculated from the equation , and then other declared features of the yachts construction and rig accrue adjustments ($Gyradius_inc$) to this base gyradius. For example carbon fibre hull construction attracts a $gyradius_inc$ of -0.010.

$$K_{yy} = 0.222 \cdot \frac{LOA + LSMH}{2} \quad [137]$$

where:

$$LSMH = 0.3194 \cdot (2 \cdot LSM1 + LSM4) \quad [138]$$

$$GYR = \frac{K_{yy}}{LSMH - 0.03 + Gyradius_inc} \quad [139]$$

Adjustments are made to the base gyradius according to the following recorded characteristics of the yacht:

1. If Mast Weight (MWT) and Mast Center of Gravity (MCG) have been recorded, the gyradius contribution of the mast is assessed as compared to that of a hypothetical base aluminum mast (Default mast weight – DMW) and a corresponding mathematical gyradius adjustment is made;

Default Mast Weight:

$$DMW = (((.00083 \cdot IG \cdot (IG + HBI)) + (.000382 \cdot IG \cdot TML))) \cdot (YP)^{0.5} \text{ (lbs)}$$



Default Mast VCG:

$$DMVCG = 0.415*(IG+P+BAS)/2 -BAS \text{ (ft) above BAS}$$

Default Rigging Weight:

$$DRW = LRW+JRW \text{ (lbs)}$$

Default Rigging VCG:

$$DRVCG = (0.372*IG*LRW+0.5*(P+BAS+0.85*IG)*JRW)/DRW - BAS \text{ (ft) above BAS.}$$

Default Mast+Rigging Weight:

$$DMW+DRW \text{ (lbs)}$$

Default Mast+Rigging VCG above BAS:

$$(DMW*DMVCG+DRW*DRVCG)/(DMW+DRW) \text{ (ft).}$$

where:

$$LRW \text{ (Lower Rigging Weight)} = 0.000155*IG*YP \text{ (lbs)}$$

$$JRW \text{ (Jumpers Rigging Weight)} = 0.000027*(P+BAS-0.85*IG)*YP \text{ (lbs) (0 for masthead)}$$

$$YP = (((RM25 * 25) + CARM * CW * \cos(25^\circ)) / (CP/2))$$

$$TML \text{ (Top Mast Length)} = 0 \text{ on masthead and } P + BAS - IG \text{ on fractional}$$

$$RM25 = \text{Righting Moment per degree at } 25^\circ \text{ heel}$$

$$CARM = \text{Crew Righting Arm}$$

$$CW = \text{Crew Weight}$$

$$CP = \text{Calculated Chainplate Width : } \text{Max}(0.46 * J, 0.135 * IG)$$

“Masthead” is defined as an $IG \geq 0.95*(P + BAS)$.

- For aestoma yacht with a carbon mast, where MWT and MCG are not recorded, the base gyradius shall be adjusted taking as mast weight:

$$MWT = DMW * \text{SQRT} (70000/170000)$$

The mast weight for carbon mast is decreased of the square root of the ratio of the Young Modulus of aluminum (70000 Mpa) and that of a very high modulus carbon mast (170000 Mpa) If the boat is fitted with fiber rigging (PBO, carbon or similar) the rigging weight will be taken as: Rigging Weight = 0.2 * DRW, being 20% of a conventional normal rod rig the weight of a aggressive fiber weight.

- Where MWT and MCG are not recorded, the number of spreader sets (including jumpers –one or zero), adjustable inner forestays and running backstays (see 810.2I) are totaled. Gyradius is increased by 0.002*CANOEL multiplied times the number by which the above total is less than 6. This total is not taken less than zero;
- If a yacht has a mizzen mast, Gyradius is increased by 0.002*CANOEL.
- An adjustment is made for the classification of hull construction as follows:
 - SOLID: 0.016*CANOEL is added to Gyradius
 - CORED: 0.008*CANOEL is added
 - LIGHT: No adjustment
 - CARBON: 0.005*CANOEL is subtracted
 - CARBON FOR C/R 0.010*CANOEL is subtracted
 - HONEYCOMB: 0.006*CANOEL is subtracted where applicable in addition to adjustments listed above;
- For each year the yacht’s Age Date is less than 1989, 0.002*CANOEL is added to Gyradius, with a maximum addition of credit for 8 years (an Age Date prior to 1981 is taken as 1981).
- If the yacht has Forward Accommodation, FWD ADJ = 0.004 (see 11 below);



8. If the yacht's rudder construction is carbon fiber, $0.003 * \text{CANOEL}$ is subtracted from Gyradius;
9. If the yacht is in the cruiser/racer division and complies with IMS Appendix 1, $\text{C/R ADJ} = 0.006$ (see 10 below);
10. Any FWD ADJ (7 above) and any C/R ADJ (10 above) shall be added together and the sum reduced according to an indicator of performance potential, i.e., sail area /volume ratio. The resulting Accommodation Gyradius Increment is calculated as follows:

$$\text{ACC GYR INCR} = (\text{C/R ADJ} + \text{FWD ADJ}) * ((0.6763 * L + 19.6926 - \text{SA/VOL}) / (0.2263 * L + 2.6926))$$
The term multiplying (C/R ADJ + FWD ADJ) shall be neither negative nor greater than 1.0.

$$\text{SA/VOL} = (\text{AREA MAIN} + \text{AREA GENOA}) / (\text{DSPTS}/1025)^{2/3}$$

$\text{ACC GYR INCR} * \text{CANOEL}$ is added to Gyradius.

11. If there is light material such as titanium or carbon used in lifeline elements (stanchions, pulpits, pushpits, etc.) the $\text{gyrad_inc_fraction_of_L}$ is decreased by 0.005

6.5.2.2 Cruiser/Racer pitch gyradius allowance scheme

This credit scheme is intended to allow for the greater pitching inertia of boats that race with anchor and chain in the bow (anchor and chain should be located in the forward 30% of the boat and should be lodged in forepeak fully reachable from deck).

The total gyradius increment due to the anchor and chain shall not be taken as more than $0.013 * \text{CANOEL}$. The gyradius increment will be added to the gyradius derived in.



7 Environment

7.1 Wind Triangle

The wind triangle relationships as implemented in the VPP include the effects of heel and the assumed wind gradient. The VPP resolves the total aerodynamic force relative to the fore and aft center plane of the mast, a lift force normal to it and a drag force in the plane of the mast. Therefore in order to introduce the effect of heel the True wind vector is modified as follows:

First, the True wind vector is resolved into components perpendicular and parallel to the yacht's velocity vector. Only the perpendicular component is multiplied by the cosine of the heel angle. To account for the variation in True Wind Velocity with height, both components are multiplied by a factor representing this change. Once this is done, the now modified True wind vector can be used in the normal vector analysis to yield the apparent wind vector at the centre of effort of the sails.

$$V_{Tz} = V_{Tzref} \cdot \left(\frac{z}{zref} \right)^{0.109} \quad [140]$$

where:

Z = height above water plane
zref = reference height for V_T measurements

The apparent wind angle (β_A) is calculated from the following formula.

$$\beta_A = \tan^{-1} \left(\frac{V_T \cdot \sin \beta_T \cdot \cos(\phi)}{V_T \cdot \cos \beta_T + V_S} \right) \quad [1311]$$

The corresponding apparent wind speed (V_A) is calculated as follows.

$$V_A = \sqrt{(V_T \cdot \sin \beta_T \cdot \cos \phi)^2 + (V_T \cdot \cos \beta_T + V_S)^2} \quad [142]$$

7.2 Sailing Angles

The VPP calculates the sailing speed at the following True Wind Angles and wind speeds:

Velocity Prediction in Knots for True Wind Speeds							
Wind Velocity	6 kt	8 kt	10 kt	12 kt	14 kt	16 kt	20 kt
Beat Angles	44.5°	42.1°	39.2°	37.7°	36.7°	36.1°	35.7°
Beat VMG	3.85	4.63	5.07	5.34	5.51	5.62	5.71
52°	5.98	6.91	7.33	7.55	7.70	7.79	7.88
60°	6.37	7.19	7.59	7.80	7.95	8.05	8.15
75°	6.66	7.41	7.87	8.15	8.32	8.44	8.60
90°	6.63	7.45	7.99	8.27	8.57	8.77	8.99
110°	6.40	7.29	7.85	8.33	8.76	9.06	9.46
120°	6.03	7.03	7.64	8.13	8.60	9.07	9.85
135°	5.10	6.37	7.16	7.70	8.16	8.61	9.61
150°	4.21	5.39	6.40	7.12	7.65	8.09	8.95
Run VMG	3.65	4.67	5.55	6.29	6.94	7.46	8.31
Gybe Angles	140.8°	144.4°	151.7°	162.2°	169.9°	174.1°	175.3°

Table 13 - VPP True wind angle and wind speed matrix

The calculations are done for the upwind sails (mainsail and jib) and downwind for the mainsail with each declared off wind sail.

The results are polar curves for each True wind speed, and the program then chooses the sail combination to produce best speed and uses this in the table of handicaps.



7.2.1 *Velocity Made along the Course. (VMC)*⁴⁵

The VMC concept is similar to the VMG for upwind or downwind sailing. The goal is to reach the mark, which is at an hypothetical prescribed heading, in the minimum time. This is accomplished sometimes by a course different from the straight, shortest one. Sometimes a course made of two legs, one closer to the wind and the other farther from it, is faster than the direct one. The implementation of this concept is made by calculating the best VMC for the (TWS, TWA) printed in the certificate, but using a splined continuous polar of the best performance of the boat evaluated at two degree intervals.

⁴⁵ 2011

8 Handicapping

8.1 VPP results as used for scoring

8.1.1 Velocity prediction

All the calculations performed by LPP and VPP after taking in account Dynamic and Age allowances are eventually used in calculations of speed predictions for 7 different true wind speeds (6-8-10-12-14-16-20 knots) and 8 true wind angles (52°-60°-75°-90°-110°-120°-135°-150°), plus the 2 “optimum” VMG (Velocity Made Good) angles: beating (TWA=0°) and running (TWA=180°), which are calculated obtaining an optimum angle at which the VMG is maximized. The calculations are done for the upwind sails (mainsail and jib) and downwind for the mainsail with each declared off wind sail, where the program then chooses the sail combination to produce best speed.

Velocity Prediction in Knots for True Wind Speeds							
Wind Velocity	6 kt	8 kt	10 kt	12 kt	14 kt	16 kt	20 kt
Beat Angles	44.6°	42.4°	39.6°	38.1°	37.3°	36.7°	36.3°
Beat VMG	3.88	4.66	5.09	5.35	5.53	5.63	5.72
52°	6.04	6.98	7.39	7.62	7.76	7.86	7.94
60°	6.44	7.27	7.66	7.88	8.02	8.12	8.23
75°	6.92	7.66	8.04	8.27	8.42	8.54	8.72
90°	7.04	7.74	8.21	8.57	8.79	8.96	9.23
110°	6.62	7.43	7.98	8.47	8.93	9.31	9.88
120°	6.18	7.15	7.76	8.26	8.74	9.21	10.14
135°	5.22	6.50	7.28	7.82	8.29	8.75	9.79
150°	4.31	5.50	6.51	7.24	7.76	8.21	9.09
Run VMG	3.73	4.76	5.65	6.39	7.05	7.58	8.44
Gybe Angles	140.7°	144.2°	151.8°	162.2°	170.4°	174.7°	175.7°

Table 14 - Velocity prediction printed on the 1st page of the ORC International certificate

8.1.2 Time allowances

The unique feature of ORC Rating system, making it fundamentally different from any other handicap system and much more precise, is its capacity to give and rate different handicaps for different race conditions because yachts do not have the same performance in different conditions. For example, heavy under-canvassed boats are slow in light airs but fast in strong winds. Boats with deep keels go well to windward and light boats with small keels go fast downwind.

This means that yachts will have a variable time allowance in any race depending on the weather conditions and the course configuration for that particular race as managed by the Organizer.

For the purpose of the Performance Curve Scoring as defined in the ORC Rating Rule 402, velocity predictions are also expressed as time allowances in s/NM where $TA = 3600/v$.

TIME ALLOWANCES							
Wind Velocity	6 kt	8 kt	10 kt	12 kt	14 kt	16 kt	20 kt
Beat VMG	927.6	771.9	706.8	672.3	651.5	639.0	629.8
52°	596.0	516.0	486.9	472.6	463.8	458.3	453.2
60°	559.0	495.3	469.7	457.0	448.8	443.4	437.7
75°	520.1	469.7	447.8	435.3	427.3	421.5	412.9
90°	511.1	465.1	438.4	419.9	409.5	401.9	389.9
110°	544.2	484.5	451.2	425.2	403.3	386.6	364.4
120°	582.1	503.2	464.1	435.8	411.9	390.7	355.0
135°	690.3	554.2	494.4	460.3	434.1	411.5	367.8
150°	835.9	654.7	552.7	497.3	463.8	438.3	396.0
Run VMG	965.2	756.0	637.5	563.1	510.7	475.2	426.7
Selected Courses							
Windward / Leeward	975.5	787.0	689.5	632.1	594.5	569.5	539.1
Circular Random	790.4	643.4	565.5	520.4	492.2	473.0	447.3
Ocean for PCS	899.6	708.8	601.4	534.7	490.1	458.2	413.9
Non Spinnaker	849.0	683.5	594.3	542.0	509.4	487.9	460.5

Table 15 - Time Allowances and Selected Courses on the 1st page of the ORC International certificate

From the time allowances calculated for 9 wind angles and 7 wind speeds, 4 types of pre-selected courses are also available:

- a) **Windward/Leeward** (up and down) is a conventional course around windward and leeward marks where the race course consists of 50% upwind and 50% downwind legs;
- b) **Circular Random** is a hypothetical course type in which the boat circumnavigates a circular island with the true wind velocity held constant;
- c) **Ocean for PCS** is a composite course, the content of which varies progressively with true wind velocity from 30% Windward/Leeward, 70% Circular Random at 6 knots to 100% Circular Random at 12 knots and 20% Circular Random, 80% reach at 20 knots;
- d) **Non-Spinnaker** is a circular random course type (see above), but calculated without the use of a spinnaker.

8.1.2.1 Wind averaging

The selected courses are calculated applying a “wind averaging” operator that smooths the individual performance curves for each yacht, taking into account not only each considered wind speed as calculated by the VPP, but a normal distribution across the range that accounts for the 23.58% of the accounted wind speed, 19.8% for 2 kts above and below, 11.73 for +-4 kts, 4.89 for +-6 kts, and 1.79 for +- 8 kts.

The wind averaging operator algorithm for the Windward/Leeward (W/L) selected course is different from the one used for the other selected courses. It is not used for the constructed course method.

8.2 Simple scoring options

ORC International and ORC Club certificates are also providing simple scoring options using the ratings determined as single, double or triple number. For any of the simple scoring options, ratings are given for the offshore (coastal/long distance) and for the inshore (windward/leeward) courses.

SCORING OPTIONS						
	OFFSHORE COASTAL / LONG DISTANCE			INSHORE WINDWARD / LEEWARD		
	Time On Distance	581.9			646.5	
Time On Time	1.0311			1.0441		
Performance Line	PLT		PLD	PLT		PLD
	0.838		84.1	1.207		377.4
Triple Number	Low	Medium	High	Low	Medium	High
	1.0309	1.2987	1.4539	0.7807	1.0450	1.2089

Table 16 - Simple scoring options on ORC International & ORC Club certificate

8.2.1 Time on Distance

$$Corrected\ time = Elapsed\ time - (ToD \times Distance)$$

Offshore Time on Distance coefficient is GPH, a General Purpose Handicap also used as an average representation of all time allowances for simple comparisons between boats and possible class divisions. It is calculated as an average of the time allowances of 8 and 12 knots true wind speed for the Circular Random pre-selected course.

Inshore Time on Distance coefficient is calculated as the average of windward/leeward time allowances in three conditions multiplied by their respective weights:

- 25% WW/LW 8
- 40% WW/LW 12
- 25% WW/LW 16

8.2.2 Time on Time (ToT)

$$\text{Corrected time} = \text{ToT} \times \text{Elapsed time}$$

Offshore Time on Time coefficient is calculated as 600/Offshore ToD.

Inshore Time on Time coefficient is calculated as 675/Inshore ToD.

8.2.3 Performance line

$$\text{Corrected time} = (\text{PLT} * \text{Elapsed time}) - (\text{PLD} * \text{Distance})$$

Performance Line Scoring is a simplified variation of Performance Curve Scoring, where curve of time allowances as a function of wind speed is simplified by the straight line intercepting the performance points of 8 and 16 knots of wind for a given course (Figure 36).

Figure 36 - Performance line scoring

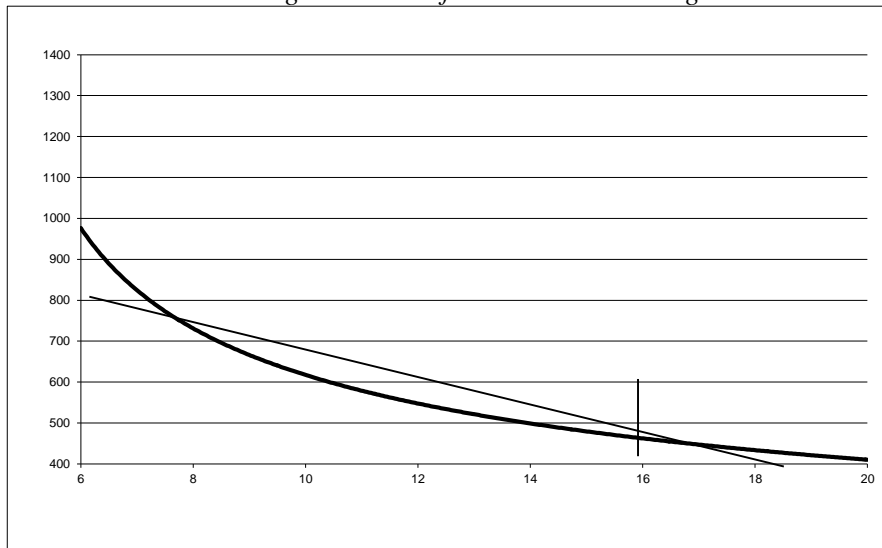

Offshore Performance line coefficients are calculated using time allowances for the Ocean type of pre-selected course.

Inshore Performance line coefficients are calculated using time allowances for the Windward/leeward type of pre-selected course.

8.2.4 Triple Number

$$\text{Corrected time} = \text{ToT (Low, Medium or High)} * \text{Elapsed time}$$

Triple number scoring coefficients are given are given for three wind ranges:

- 1) Low range (less than 9 knots)
- 2) Medium range (equal or more than 9 but less than 14 knots)
- 3) High range (14 or more knots)

The ToTs displayed on the certificate are derived as follows. The three wind velocity ranges (Hi, Medium, Low) are each comprised of weighted averages of several Time Allowances (s/NM) selected from the familiar seven ORC wind speeds. The “cookbook” recipe for proportions in each of the three wind ranges is given in Table 17. The result is a form of wind-averaging for each of the three Triple Number wind ranges:

Wind Speed:	6 kt	8 kt	10 kt	12 kt	14 kt	16 kt	20 kt
Low Range	1 part	1 part					
Med Range		1 part	4 parts	4 parts	3 parts		
Hi Range					2 parts	3 parts	3 parts

Table 17 - Time allowance weighting table

Once a single weighted average sec/mi Time Allowance has been calculated for each of the three wind ranges, these are converted to a ToT by the formula $ToT = 675/TA$.

Offshore Triple Numbers coefficients are calculated using time allowances for the Circular Random type of pre-selected course.

Inshore Triple Numbers coefficients are calculated using time allowances for the Windward/leeward type of pre-selected course.

8.2.5 OSN (Offshore Single Number) handicap

The re-formulation of the Offshore Single Number (OSN) Handicap is based on different courses and wind speed to more accurately reflect the race course geometries used. OSN is further fine-tuned in 2014.

The OSN is calculated as a weighted average of the following sec/ml TIME ALLOWANCES (not wind averaged):

TWS	8	12	16
Beat VMG	40%	30%	20%
60	5%	15%	20%
90	5%	10%	15%
120	5%	15%	20%
150	5%	15%	15%
Run VMG	40%	15%	10%

The resulting time allowance at 8 kts TWS will be accounted at 25%, the one at 12 kts TWS at 50% and that at 16 kts at 25%.

The above scheme takes into account more windward/leeward in light winds that gradually is reduced to have more reaching as the TWS increases. This is quite different from present GPH that is an average of circular random 8 and 12, being hence more moved to strong winds and with less reaching in light winds.

The overall OSN is generally 5% faster than current GPH in average, and this reflects the average speed of boats during an offshore race.

GPH is retained in any case not only as an handicap but also to identify boats and classes and because it is used as reference by crews and owners.

8.2.6 Class Division Length (CDL)

In 2014 ITC noted two fundamental issues related to class divisions based on GPH:

- 1) the low possibility to design fast yachts in lower divisions without being compelled to make them too small to fit in the GPH limits. The consequence is that the winners of the lower divisions are always medium/heavy displacement boats, usually the largest in their class.
- 2) the first windward leg of the inshore races is a fundamental part of the race and it should be better to have as many boats as possible with similar windward speed in the same class.

In the past, to solve the first issue the smallest boats of the larger class were moved according to a fixed length limit, or conversely pushed up into the larger class with boats exceeding a certain length, but this caused complaints.



To answer the second issue, ITC decided to select the Windward12 (UP 12) handicap instead of using GPH to group boats with similar upwind speeds into the class. To also maintain similar dimensions it was decided to couple the windward speed at TWS=12 kts with the sailing length (IMS L) of each boat.

To couple the two factors (UP12 and IMS L) it was decided to transform the WW12 allowance (that is a speed) in a length and average the obtained length with IMS L. The final factor was named CDL (Class Division Length)

The transformation in length of the UPWIND12 allowance is obtained with the following formulation:

$$VMG_{UP12} = \frac{3600}{UP12} \cdot 0.5144 \quad \text{where } VMG_{UP12} \text{ is boat upwind speed in m/s at 12 kts wind}$$

$$RL = \frac{VMG_{UP12}^2}{F_n^2 \cdot 9.81} \quad \text{where RL is rated length and } F_n \text{ is Froude number set at 0.28}$$

The RATED LENGTH is the length that you should have at $F_n=0.28$ with the VMG_{UP12} speed, so it is transforming a speed into a length. Froude number of $F_n=0.28$ for upwind VMG was fixed using $F_n=0.4$ (that is the Froude number at around which maximum displacement speed is obtained) multiplied by $\cos(45^\circ)$, 45° being the average true wind angle upwind.

The Class Division Length is then calculated as follows:

$$CDL = \frac{IMSL + RL}{2}$$

The CDL, coupling a speed (or a handicap in sec/mi) and a length, is addressing the problem of mixing handicap and dimensions of boats returning more homogenous classes in terms of dimensions and speed.

9 Appendix A: Offset File (.OFF) Format

Offset file describes the shape of the hull together with appendages as a sequence of point measurements arranged in transverse stations. Points along the selected stations are taken from the bottom up with an ORC approved hull measurement device capable to produce a list of the points in the co-ordinate system as follows:

- a) X axis – longitudinal with 0 at stem and positive towards the stern
- b) Y axis – transverse with 0 at the centerline and positive towards the beam
- c) Z axis – vertical with 0 at the waterline and positive upwards

Stations are taken at 5% intervals, doubled to 2.5% in the front 15% of the hull. The measurements taken on port and starboard sides are collapsed in the OFF file as if they were on a single side, but they are identified by a station code, which is 1 for starboard and 2 for port. Freeboard stations are measured from both sides. Appendages such as keel and rudder are measured along transverse stations as any other, and extra stations need to be placed at any vertex of appendage in its profile.

Moveable appendages as centerboards, daggerboards and bilgeboards if fitted, don't need to be measured. There is a maximum limit in the LPP of 180 points per station and 180 stations. The LPP may add points and stations internally.

Units may be in decimal feet *100, or integer millimeters.

OFF file is an ASCII file format with the fields separated by commas and in the required character positions as follows:

First 4 lines are header with general hull data as follows:

```
HH:MM:SS, DD/MM/YY, MEAS#, MACH, FILE, CLASS, 1MMYY
  0.000,  0.000,  0.000,  0.000
  0.000,  0.000,  0.000,  0.000
    NST,   LOA,   SFJ, SFBI
```

Line 1

<u>Label</u>	<u>Columns</u>	<u>Explanation</u>
HH:MM:SS	1-9	Time of measurement
DD/MM/YY	11-20	Date of measurement
MEAS#	22-26	Measurers code
MACH	28-31	Machine code. (If ≤ 0 measurements are in ft*100)
FILE	33-39	File name
CLASS	41-64	Class
1MMYY	66-70	Age date with month and year. "1" in front is added for 2000 and following years

Line 2&3 (Metric System)

```
SFFPs, FFPVs, SAFP, FAPVs
SFFPp, FFPVp, SFFPs, FAPVp
```



<u>Label</u>	<u>Columns</u>	<u>Explanation</u>
SFFPs, SFFPp	1-8	Distance from stem to the forward freeboard station (port & starboard)
FFPVs, FFPVp	10-16	Vertical distance from the forward freeboard station uppermost point to the sheerline where sheer point can not be taken (port & starboard)
SAFPs, SAFPp	18-24	Distance from stem to the aft freeboard station (port & starboard)
FAPVs, FAPVp	26-32	Vertical distance from the forward freeboard station uppermost point to the sheerline where sheer point can not be taken (port & starboard)

Line 2&3 explanation (US option)

-99, FFLAP, FALAP, FGOLAP
LBGLAP, KLEPFG, dummy, dummy

In this alternative format that is associated with a number of HMI US machines in line 2 field 1 is a negative number, which means also that measurements are in ft*100. This is followed by IOR existing freeboard measurements and locations, and the “wing keel” indicator, that usually is defined by a code “4” applied in the wing/bulb widest point. This is obsolete after 2005 due to a different treatment of the wing/bulb keel aerodynamics. The last 2 fields of line 3 are just spare in this optional formatting.

Line 4

<u>Label</u>	<u>Columns</u>	<u>Explanation</u>
NST	6-8	Number of stations
LOA	10-16	Length overall
SFJ	18-24	Distance from the stem to the forward end of J
SFBI	26-32	Stem to mast distance, SFJ + J. This is used to locate the mast to get HBI (Height of sheer at the Base of I).

Note: SFJ and SFBI are set to zero in most files and are not relevant.

Stations definitions

The stations are arranged from bow to stern (increasing X) regardless of being port or starboard. The first station should be placed so the stem of the yacht is at X=0.0. X should never be a negative number. Stations should be taken so that a plot in elevation view of the bottom points of the stations defines all discontinuities in the underwater profile. Stations are needed at all knuckles, where the keel and rudder meet the canoe body, the bottom corners of the keel, bulb and rudder. The maximum thickness of the appendages should also be defined, and a double station in way of the keel is recommended. A station should be taken close to the stem and the extreme aft end of the boat.

Line 5 and the following lines contain information about each section in the following sequence:

```

X, NPT, SID, SCD, sta#
Z (1) ,      Y (1) , PTC
Z (2) ,      Y (2) , PTC
Z (3) ,      Y (3) , PTC
Z (4) ,      Y (4) , PTC
...
...
Z (NPT) ,      Y (NPT) , 1

```

First line of each station

<u>Label</u>	<u>Columns</u>	<u>Explanation</u>
X	1-10	Distance from the stem for each station in millimeters for metric units, in hundredths of feet for imperial units
NPT	12-14	Number of points in a section. Important to be correct.
SID	16-18	Side code: 1-Port; 2-Starboard; 3-Both
SCD	20-22	Station label: 1-Forward freeboard; 2-Aft freeboard; 3-Station contains prop shaft exit point; 4-Station contains propeller hub point
sta#	24-27	Station count, not necessary, but included for convenience

Station points definition

<u>Label</u>	<u>Columns</u>	<u>Explanation</u>
Z(n)	1-10	Vertical co-ordinate for points on a half section, positive up, negative down in millimeters for metric units, in hundredths of feet for imperial units
Y(n)	11-21	Horizontal distance from the centerline for points on a half section. Negative only in the gap in section for example, between the canoe body and the trailing edge where point code PTC is set to 2.
PTC	23-25	Point code as explained below

Point codes:

- 0 - Normal hull point.
- 1 - Sheer point. If no point on a station has a point code of 1, the top point on the station becomes the sheer point.
- 2 - Poke-through (empty space in a gap bounded by the point immediately above and below. More commonly represented by a Y (transverse offset) of less than -0.3 feet.
- 3 - Propeller or shaft exit point (the appropriate station code having already been entered).
- 4 - Maximum width points of a wing keel.
- 5 - US measurement machine centerline points (has no rating effect).
- 6 - Propeller aperture bottom point (may exist in some old US offset files).
- 7 - Propeller aperture top point (may exist in some old US offset files).
- 8 - Poke-through on the leading edge of an appendage. Most of the time, the program can decide automatically if one or more stations with poke-throughs are leading or trailing edge. If an appendage with leading edge poke-throughs plots incorrectly, this may help.
- 9 - Poke through on the trailing edge of an appendage. If an appendage with trailing edge poke-throughs plots incorrectly, this may help.
- 10 - Poke-through in a closed hole through an appendage. There is no automatic recognition of holes.
- 11 - Poke-through in a contiguous set of stations that all have poke-throughs which completely sever the appendage from the hull. This code will limit the appendage profile to only those points below the poke-throughs.
- 12 - Do NOT clip at this specific point. Use on points which are the inside corner of a left turn while scanning down the section. This is typically used to prevent clips at hard chines with lips or lapstrake type construction.
- 13 - Prevent clipping of entire stations narrower than 3 percent of BMAX by setting this code on any point in the station. This would be typically used on the very tip of a transom that comes to a point. This code will not prevent a clip at a left turn or poke through in the station.
- 14 - If this code is set on any point in the station, you force clipping of the entire station even though it may be wider than 3% of BMAX, and regardless of any poke-throughs and left turns.
- 15 - Do not clip this station in any way, either entirely or at any point if this code is set on any point in the station.
- 16 - Force a clip at this point.



Double Rudder

Data on the double rudder are entered as an extra input line in the .OFF file.

r_yoff	r_xoff	r_span	r_chordroot	r_chordtip	r_thicknessroot
Y offset	X offset	Rudder Spa	Root Chord	Tip Chord	Root thickness
r_thicknesstip	Angle y_off	r_xoff	angle		
Tip Thickness	the stagger form CL of the root. if =0 means single rudder.	longitudinal position of centroid.	lateral inclination angle compared to vertical		