

Owner's
Manual
&
Reference



GPS 45 Personal Navigator™

 **GARMIN**

GPS 45 Personal Navigator™ OWNER'S MANUAL

Introduction

Foreword

Software Version 2.20 or above

© 1994 GARMIN INTERNATIONAL
9875 Widmer Road, Lenexa, KS 66215, USA

All rights reserved. No part of this manual may be reproduced or transmitted in any form or by any means, electronic or manual, including photocopying and recording, for any purpose without the express written permission of GARMIN.

Information in this document is subject to change without notice. GARMIN reserves the right to change or improve their products and to make changes in the content without obligation to notify any person or organization of such changes or improvements.

April 1994

Part #190-00070-00 Rev. B

Printed in Taiwan.

CAUTION

The GPS system is operated by the government of the United States, which is solely responsible for its accuracy and maintenance. The system is under development and is subject to changes which could affect the accuracy and performance of all GPS equipment. Although the GPS 45 is a precision electronic NAVigation AID (NAVAID), any NAVAID can be misused or misinterpreted, and therefore become unsafe.

Use the GPS 45 at your own risk. To reduce the risk of unsafe operation, carefully review and understand all aspects of this Owner's Manual and thoroughly practice operation using the simulator mode prior to actual use. When in actual use, carefully compare indications from the GPS 45 to all available navigation sources including the information from other NAVAIDS, visual sightings, charts, etc. For safety, always resolve any discrepancies before continuing navigation.

NOTE: This device complies with Part 15 of the FCC rules. Operation is subject to the following two conditions: (1) This device may not cause harmful interference, and (2) this device must accept any interference received, including interference that may cause undesired operation.

Preface

Welcome to the smallest, easiest-to-use GPS navigator on the water! The GPS 45 represents GARMIN's continuing commitment to provide mariners with quality navigation information in a versatile, accurate and user-friendly design you'll enjoy for years to come.

To get the most of your new GPS unit, it is important that you take the time to read through this owner's manual to understand the operating features of the GPS 45. The manual is organized into two sections for your convenience:

Section One introduces you to the basic features of the unit and provides a quick-start orientation to the GPS 45. It has been designed to acquaint you with the unit and provide a basic working knowledge necessary to use the unit in typical conditions.

Section Two provides a detailed reference to the advanced features and operations of the GPS 45 in a topical format. This allows you to concentrate on a specific topic quickly, without reading through entire sections of text that you may not need.

Thanks for choosing the GARMIN GPS 45. If you have any questions or comments regarding the use of the GPS 45, our Product Support staff is available to serve you at 1-800-800-1020 or 913-599-1515. You can also reach our Product Support staff by FAX at 913-599-2103.

GPS 45 Capabilities

Designed for easy operation, the GARMIN GPS 45 offers powerful features that make marine navigation come alive in the palm of your hand:

Precision Performance

- MultiTrac8™ receiver tracks and uses up to 8 satellites simultaneously for fast, accurate positioning
- Differential-Ready— just add the optional GBR 21 beacon receiver for under 10 meter accuracy
- Waterproof, dry nitrogen-filled case for all-weather use
- Up to 20 hours of battery life on 4 AA alkaline cells in battery saver mode

Advanced Navigating and Plotting

- 250 alphanumeric waypoints
- List of 9 nearest waypoints
- 20 reversible routes
- MOB mode with bearing and distance to mark
- Moving Map Plotting with scales to 1/5th statute mile
- Graphic pages for Satellite Status, Position, Plotting and CDI Navigation
- Active graphic display of cardinal heading

Simple, One-Handed Operation

- Efficient 2-speed thumbkey control
- Weighs just 10 ounces with batteries

Before getting started with your new GPS receiver, check to see that your GARMIN GPS 45 package includes the following items. If you are missing any parts, please see your dealer immediately.

Standard Package:

- GPS 45 Receiver with Removable Antenna
- Carrying Case
- GPS 45 Owner's Manual
- 4 AA Batteries
- Quick Reference Card
- Warranty Registration Card

Optional Accessories:

- Swivel Mounting Bracket
- Power/Data Cable
- Remote Mount Marine Antenna
- Low-Profile Automobile Antenna
- Cigarette Lighter Adapter
- PC Kit

See your local GARMIN dealer for optional accessories.

Table of Contents

SECTION ONE Getting Started

GPS Overview	2
Basic Definitions	3
Power On/Status and Position	4-5
Marking a Position	6
Moving Map Basics	7
GOTO and Steering Guidance	8-9
Pages and Menus	10
Time Offset and Power Off	11
Keypad Usage/Operation Flowcharts	12-14

SECTION TWO Reference

Satellite Status Page	15-16
Position Page Options	17
Creating and Using Waypoints	18-24
GOTOs and MOB Mode	25-26
Creating and Using Routes	27-32
Moving Map Plotting	33-36
Menu Page and Auxiliary Functions	37-46
Battery and Antenna Installation	47
Appendix A—Glossary	48
Appendix B—Messages	49-50
Appendix C—Time Offset	51
Appendix D—Map Datums	52-53
Appendix E—Maintenance and Specifications	54
Appendix F—Electrical Wiring and Installation	55
Appendix G—Mounting Bracket Installation	56-57
Appendix H—Index	59-60

What is GPS?

GPS (Global Positioning System) is a satellite-based navigation system developed by the U. S. Department of Defense to provide a consistent, accurate method of simplifying navigation. Originally designed for military applications, it also provides commercial and recreational users with 24-hour, worldwide navigation coverage with accuracy to 15 meters (49 feet).

How Does GPS Work?

GPS navigation uses satellite ranging to determine your position in relation to a set of satellites orbiting the earth. The GPS constellation is made up of 24 satellites, which continuously send radio signals containing precise position and time information for each satellite back to earth.

By knowing the position of any 3 or 4 of these satellites and calculating various time differences between the transmitted signals, your GPS receiver can determine its present position anywhere on earth. And once you're under way, your GPS continuously updates your position and provides speed and track information.

What are the Advantages of GPS Navigation?

For centuries, mariners have been searching for an accurate method of travelling the world's waterways. From celestial navigating to loran and SatNav, each system has had its problems with weather, range and reliability.

GPS takes navigation to a higher level by providing accurate position and course information, anywhere in the world, regardless of the weather or your proximity to land. The accuracy and coverage of GPS navigation can help make your boating safer, smarter and more efficient wherever you may travel.

The GPS 45 is a powerful navigation tool that can guide you anywhere in the world. To better understand its operation and capabilities, it may be helpful to review the basic terms and concepts briefly explained below.

Navigation is the process of traveling from one place to another and knowing where you are in relation to your desired course.

Position is an exact, unique location based on a geographic coordinate system. Marine navigation is based on the latitude/longitude coordinate system.

Meridians of longitude are a set of imaginary circles around the earth that pass through the north and south poles. Longitude describes position in terms of how many degrees it is east or west of the Prime Meridian (0° longitude).

Parallels of latitude are another set of imaginary circles that are perpendicular to the earth's polar axis. Latitude describes position in terms of how many degrees it is north or south of the equator (0° latitude).

A **waypoint** marks an exact position fix so it can be recalled for future use. The GPS 45 lets you mark waypoints electronically, without physical landmarks.

Bearing is a compass direction to a particular destination (waypoint) from your present position.

Track is a compass direction representing your course over ground.

Getting Started

Power On

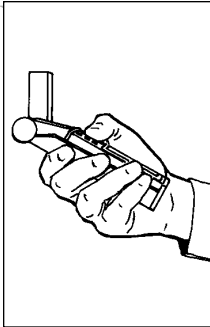

Hold the receiver at a comfortable height, at arm's length from your body. If you prefer, find a steady surface to set the unit on while it acquires satellites.



Welcome Page

The first time you power up your new GPS 45 is an important step in getting the best possible GPS performance. The receiver must be given an opportunity to collect satellite almanac data and establish its present position. This process can take 7 1/2-15 minutes, and is only necessary for first time operation or after memory loss.

Take the GPS 45 outside and find a large, open area (try a nearby park) that has a clear view of the sky from horizon to horizon.



Do your best to stay away from buildings or other structures that could block the path of signals to the receiver. Although GPS signals will travel through glass and canvas biminis, they do not travel through buildings, metal surfaces or other significant structures.

You're now ready to power up and discover the world of GARMIN GPS navigation.

1. Rotate the antenna so it's pointing up, perpendicular to the ground.
2. Press the  key firmly to turn the unit on.

The Welcome Page will be displayed while the unit conducts a self test. Once testing is complete, the Welcome Page will be replaced by the Status Page and the unit will begin acquiring satellite data.

While the GPS 45 is acquiring satellite data, relax and browse through the rest of the Getting Started section of the manual. If you're new to GPS navigation, be sure to review the GPS Overview and Basic Navigation Terms on pages 2 and 3.



To prevent accidental battery power loss, the GPS 45 will automatically shut off 15 minutes after the last keystroke if the unit is not tracking at least one satellite and has never acquired a position fix.

The GPS 45's Status Page provides a visual reference of satellite acquisition and position. As the receiver locks onto satellites, a signal strength bar will appear for each satellite in view, with the appropriate satellite number (1-32) underneath each bar.

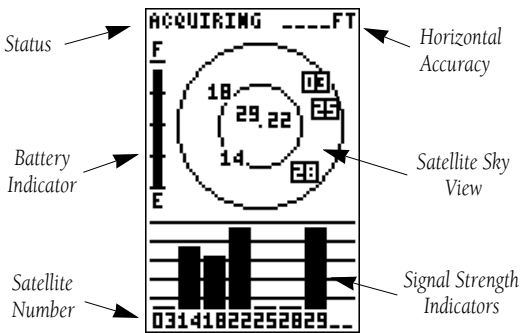

The satellite sky view shows a bird's eye view of the position of each satellite relative to the unit's last known position. The outer circle represents the horizon (north up); the inner circle 45° above the horizon; and the center point directly overhead.

Once sufficient signals have been acquired, the Status Page will be replaced with the Position Page.

The Position Page shows you where you are, what direction you're heading and how fast you are going. The graphic display at the top of the page indicates your cardinal heading (only while you're moving) with the track and speed indicated below.



The graphic compass display is designed to show your current track and does not serve as a true magnetic compass while you're standing still.

The rest of the page shows your current position in three dimensions: latitude, longitude and altitude. The GPS 45 uses this basic information to mark exact positions as waypoints, which help guide you from one place to another.

The sky view will help you determine if a satellite signal is being blocked by buildings, mountains or other obstructions. As satellites are locked onto, the sky view indicators will change from a reverse-video highlight to a standard display.

If you encounter difficulty acquiring satellite signals, try facing another direction or walk towards a clearer view of the horizon.

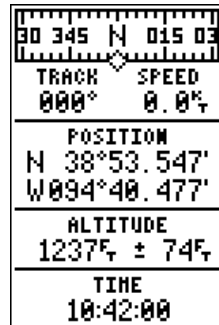

Position Page

Getting Started

Marking a Position

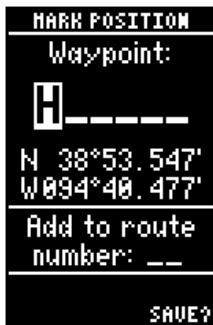

Getting to know your new GPS is as easy as taking a quick stroll around an open outdoor area. To get the most out of this tutorial, make sure to walk for at least the time noted for each step. This way, you'll reduce the chances of staying within the receiver's margin of error. You'll also get a much better indication of the unit's visual guidance and mapping capabilities.

Once you've acquired a position, mark it as a waypoint for future reference.

1. Press the **MARK** key to capture and hold your present position.

The Mark Position Page appears, showing the captured position and a default 3-digit waypoint name. Let's change the default name to something that's a little more meaningful.

1. Press the **▲** key twice to move the field highlight from the 'save' field to the name field.
2. Press the **ENTER** key to begin entry of your waypoint name.
3. Press and hold the **▲** key to scroll through the alphabet until the letter 'H' appears.
4. Press the **▶** key once to move the character highlight to the next character space.
5. Repeat steps 3 and 4 until the word 'HOME' is displayed.
6. Press **ENTER** to complete entry of the name.
7. Press the **▼** key once to return the field highlight to the 'save' field.
8. Press the **ENTER** key to confirm that you want to save the position as a waypoint named 'HOME'.

The Mark Position Page will be replaced by the page displayed prior to pressing the **MARK** key.

Now that you've marked a position, it's time to take off on a brisk walk and put your GPS 45 through its paces.

1. Walk in a straight line for 2-3 minutes at a fast pace and watch the Position Page. You can time your distance with the on-screen clock.

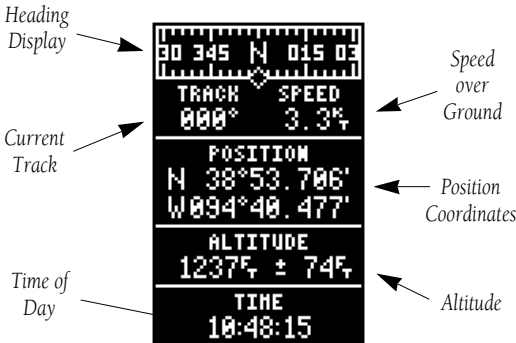

The direction you are moving (your track) and your speed are displayed on the upper part of the screen, just below the graphic compass display. The latitude, longitude and approximate altitude of your position are continuously displayed in the center of the screen, with the time of day (in UTC time, computed from the satellites) displayed below.

Now let's change the display to the Moving Map Page and watch the track of our trip:

1. Press the **PAGE** key to change from the Position Page to the Map Page.

Your current position is shown as the diamond in the middle of the screen. The dark circle below the diamond represents the position you created, with the line between the two showing your track.

1. Now turn 90° to your right and walk at a fast pace for another 2-3 minutes.

Notice how the display changes, always keeping the direction you are moving at the top.



Map Page



The Moving Map's default setting is track up orientation. It can also be set for north up or desired track up orientation through the map setup page.

Getting Started

Going to a Waypoint

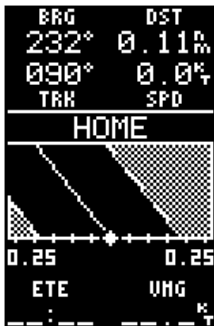

The moving highway provides a visual perspective of the distance and direction to waypoint. The highway will always move to 'point' in the general direction of your destination, with the relative distance indicated by the angle of the outside lines of the highway.

Now let's navigate back to our starting position, the HOME waypoint.

1. Press the **GOTO** key.
2. The Navigation Page will appear with the waypoint field highlighted.
3. Press the **▲** or **▼** keys to scroll through the available waypoints until 'HOME' is displayed.
4. Press the **ENTER** key to confirm that you want to navigate to the displayed waypoint.

The GPS 45 will now guide you 'HOME'.

As you begin walking again, the Navigation Page will display nav data and graphic steering guidance. The bearing and distance to waypoint, with your current track and speed are displayed at the top of the screen, with your estimated time enroute (ETE) and velocity made good (VMG, or the rate you are closing in on your destination) at the bottom.

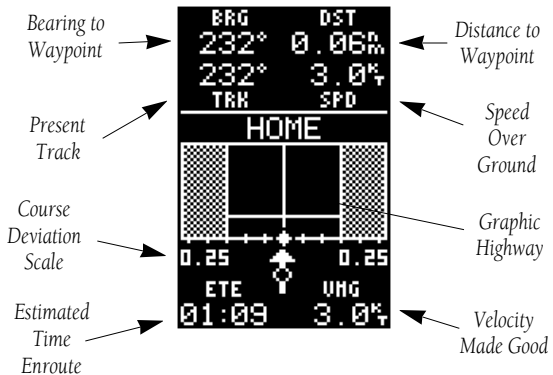

As you head towards your destination, the middle section of the screen provides visual guidance to your waypoint on a moving graphic 'highway'. The moving arrow just below the course deviation scale always points to your selected waypoint (HOME) relative to the direction you are moving.

Your present position is represented by the diamond in the center of the course deviation scale.

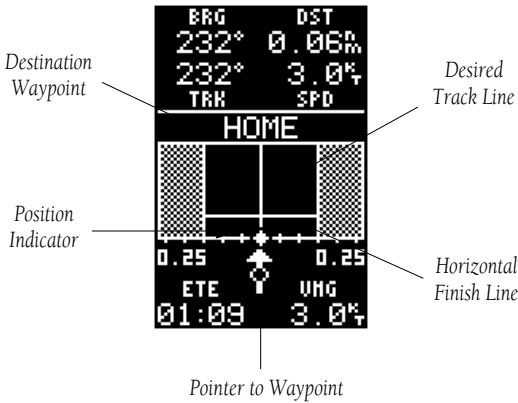

The line down the middle of the highway represents your desired track. As you navigate toward a waypoint, the highway will actually move, indicating the direction you're off course, relative to the position diamond on the CDI scale. To keep your vessel on the desired course, simply steer toward the center of the highway.

If you do get off the desired course by more than 1/5th of the selected CDI range, the exact distance you are off course will be displayed where the CDI scale setting normally appears (see the example at right). As you approach a waypoint, a horizontal 'finish line' will move toward the bottom of the highway. When the finish line reaches the CDI scale, you've arrived at your destination.

Whenever the GPS 45 has something it needs to tell you, a message indicator box will flash on screen. When you are less than one minute from reaching your HOME waypoint, the message box will begin flashing.

1. To view a message, press the **PAGE** key when the message indicator appears.
2. Press **PAGE** to return to the previous page.

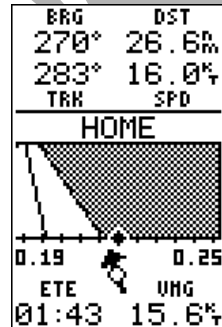

In this example, you are off the desired course to the right by 0.19 n.m. To get back on course, steer left to center the position diamond on the highway.

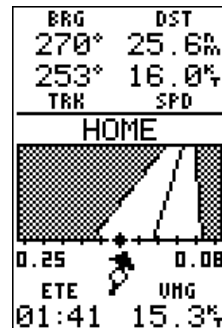

This example shows you are off the desired course to the left by 0.08 n.m. To get back on course, steer right to center the position diamond on the highway.

Getting Started

Page Sequence and Menus

Now that you've arrived 'HOME', scroll through the main pages of the GPS 45.

1. Press the **PAGE** key to scroll through the five main pages in sequence.
2. Press the **QUIT** key to scroll through pages in the opposite direction.

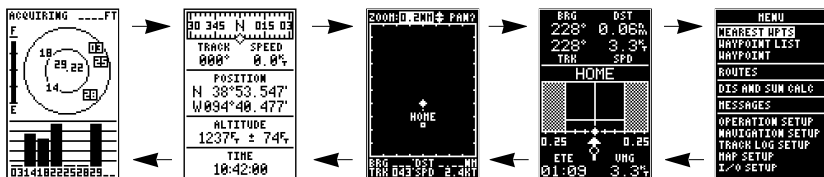

Use the Page and Quit keys to continuously scroll through the main pages in either direction.

The Menu Page allows you to view waypoint or route information and customize various functions of the GPS 45. To get a feel of how the Menu Page works, let's set the time of day for your location.

1. Press the **PAGE** or **QUIT** key until the Position Page appears. Note the longitude of your current position (the bottom position value).
2. Press the **PAGE** or **QUIT** key until the Menu Page is displayed.
3. Press the **▲** or **▼** key until 'operation setup' is highlighted.
4. Press the **ENTER** key.
5. Press the **▼** key until 'offset' is highlighted.
6. Press the **ENTER** key.

Refer to the appendix C for the appropriate UTC offset for your longitude. Remember to add 1 hour if you are in Daylight Savings Time.

Once you've found the appropriate time offset, enter it in the offset field.



To enter the time offset:

1. If you are entering a negative offset, press the ◀ key to move the character highlight to the +/- field. Press ▲ to select a negative offset.
2. Press the ▶ key to move to each character position, and use the ▲ or ▼ keys to enter an offset value in each position.
3. Press the **ENTER** key to confirm your time offset.
4. Press the **PAGE** key to return to the Menu Page.



Because time zone boundaries do not follow exact meridians of longitude, there may be some instances where the offset indicated does not result in the correct time for your position. Simply add or subtract the difference from the offset for the correct time.

You've now gone through the basic operation of your new GPS and probably know a little more than you think about how it works. We encourage you to experiment with the GPS 45 until it becomes an extension of your own marine navigation skills.

If you encounter any problems using the unit or want to take advantage of the GPS 45's advanced features, refer to the operation flowcharts and the reference section of this manual.

To turn the GPS 45 off:

1. Press and hold the **OFF** key for 3 seconds.

Thank you for choosing the GARMIN GPS 45. We hope that it will be a valuable navigation tool for you, wherever your course may take you.



The power off countdown appears right on screen while you hold the power button. This countdown helps prevent accidental shutoff and loss of data.

Getting Started

Keypad Usage



The GPS 45's two-speed thumbkey allows convenient, one-handed entry of information. Press on a particular arrow key once to scroll through data options slowly, press and hold an arrow key for faster scrolling.



- Use the up and down arrow keys to select alphanumeric characters and menu choices and to move the field highlight from field to field.



- Use the left and right arrow keys to move the selected character field and to move the field highlight from field to field.

GOTO

The GOTO key changes the display to the Navigation Page with the way-point field highlighted. Pressing GOTO twice activates the MOB mode.



The POWER key turns the unit on and off and activates screen backlighting. To turn the unit off, press and hold the POWER key for 3 seconds.

QUIT

The QUIT key returns you to a previous page, or clears data entry, restoring a data field's previous value.

PAGE

The PAGE key scrolls through main data pages in sequence and returns the display from a submenu page to the previous page viewed. It also displays the message screen when a message alert appears.

MARK

The MARK key captures a position and displays the Mark Position Page.

ENTER

The ENTER key confirms data entry and on-screen responses. The ENTER key also activates highlighted fields to allow data entry.

Getting Started

Operation Flowchart

POWER ON



POWER OFF

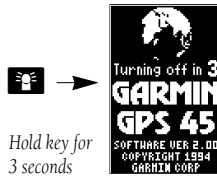

MAIN PAGE SEQUENCE

Press the PAGE key to scroll through pages in sequence.

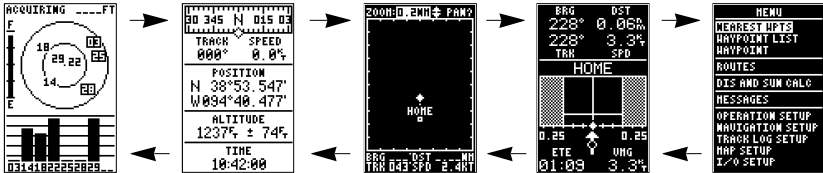

Press the QUIT key to scroll through pages in reverse order.

MARK POSITION

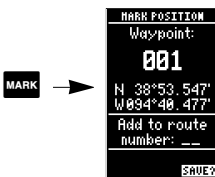

VIEW MESSAGES

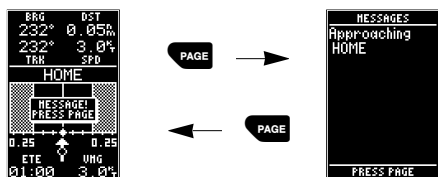

GO TO WAYPOINT

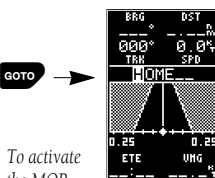

To activate the MOB function, press GOTO twice.

REVIEW WAYPOINT DEFINITION PAGE

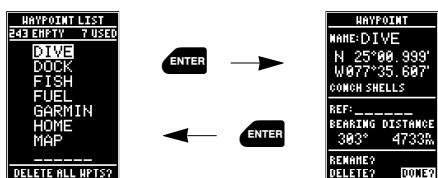

Getting Started

Operation Flowchart

SELECTING SUBMENUS FROM MENU PAGE

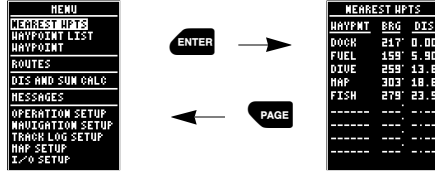

WAYPOINT LIST SUBMENU

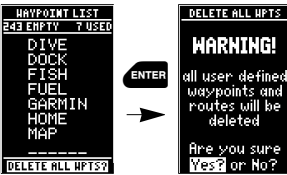

You can delete all stored waypoints only from the waypoint list submenu page.

WAYPOINT PAGE SUBMENU



The waypoint page lets you review, rename and delete any stored waypoint. Press ENTER to confirm the highlighted prompt field.

ROUTE PAGES

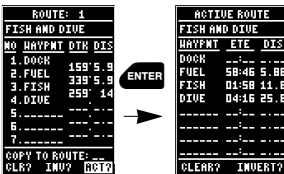

Once a route is activated, the Active Route Page will appear in the main page sequence.

SUN CALCULATION



Clearing the contents of the Active Route Page cancels the active route.

SETUP SUBMENU PAGES

OPERATION SETUP	
MODE: Simulator	
DATE 18 JAN 94	
TIME 11:01:09	
OFFSET: -00:00	
CONTRACT: _____	
BACKLIGHT TIME: 15 seconds	
TONE: MSG & Key	

NAVIGATION SETUP	
POSITION FORMAT: hddd°mm. mm'	
MAP DATUM: WGS 84	
SDI SCALE: 10, 25	
UNITS: Nautical	
HEADING: Auto Mag E004	

TRACK LOG SETUP	
RECORD TRACK: Yes	
CRITERIA: Time Interval: 00:00:00	
MEMORY USED 0% 5 OF 768 POINTS	
CLEAR TRACK LOG?	

HAP SETUP	
ORIENTATION: North Up	
PLOTTED ITEMS	
BRG: No	
ROUTE: Yes	
NEAREST: Yes	
NAMES: Yes	
TRACK LOG: 500	

I/O SETUP	
NONE/NMEA	
NMEA 0183 2.0 4800 baud	

To return from a setup page to the Main Menu Page, press the PAGE key.

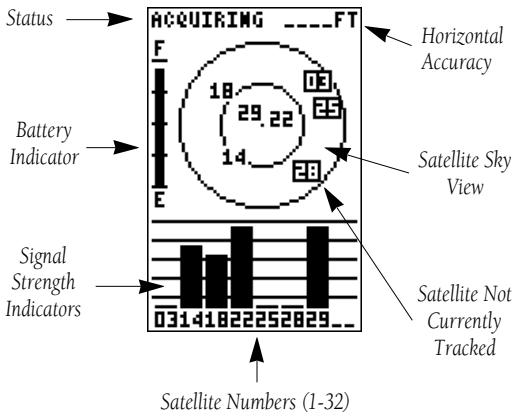

The GPS 45 Status Page displays the status of various receiver functions. The status information will help you understand what the GPS is doing at any given time.

The sky view and signal strength bars give you an indication of what satellites are visible to the receiver, whether or not they are being tracked, and the signal quality. When a satellite is visible but not being tracked, the signal strength bar will remain blank and the sky view indicator will remain highlighted in reverse video.



If you are losing coverage or having trouble acquiring a position, use the sky view and signal strength bars to guide you towards a better location for GPS reception. If you have lost coverage and the unit has trouble reacquiring satellites, try shutting the unit off momentarily to reset the unit.

Receiver status is indicated at the top left of the screen, with the current horizontal accuracy (in feet or meters) at the top right. The status will show one of the following conditions:

Acquiring Satellites is the first status you'll see in normal operation. The GPS 45 is looking for satellites to track based on its last known position.



The satellite sky view shows a bird's eye view of the position of each satellite relative to the receiver's last known position.

The outer circle represents the horizon (north up); the inner circle 45° above the horizon; and the center point a position directly over your head. Use the sky view to help determine if there are obstructions shading your reception of satellite signals.

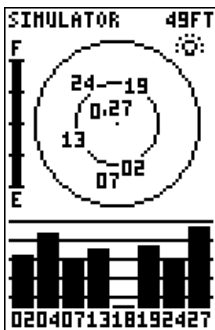
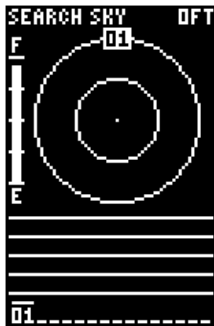
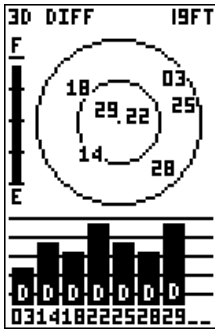

2D Navigation status indicates that at least three satellites with good geometry have been locked onto and a 2 dimensional position fix (latitude and longitude) is being calculated. '2D Diff' will appear when you are receiving DGPS corrections in 2D mode.

3D Navigation indicates that at least four satellites with good geometry have been locked onto and your position is now being calculated in latitude, longitude and altitude. '3D Diff' will appear when you are receiving DGPS corrections in 3D mode.

Searching the Sky indicates that the GPS 45 is collecting new almanac data or AutoLocate™ mode has been selected (see page 38). This process can take 7.5 to 15 minutes.

Poor GPS Coverage indicates that the receiver is no longer tracking enough satellites to provide a 2D or 3D position fix.

Simulating Navigation indicates that the receiver is in simulator mode.

Below the receiver status field and to the left of the satellite sky view is the battery level indicator.



The battery level indicator is calibrated for alkaline batteries. Ni-Cad and lithium batteries will not show the battery level at full scale due to voltage differences. No other receiver functions are affected by using Ni-Cad or lithium batteries.

On the right side of the screen, just below the horizontal accuracy field is the screen backlight indicator. When backlighting is on, a bulb icon will appear. To turn the screen backlighting on or off:

1. Press the  key.
2. To adjust the duration of screen backlighting, refer to the operation setup section (page 39).

The GPS 45 Position Page displays your current position's latitude, longitude, altitude and time numerically. It also displays your track (compass direction) and speed whenever you're moving.

The Position Page also lets you enter a position's latitude and longitude manually. During satellite acquisition, the position displayed is the last computed position stored in memory. If the receiver's position has moved several hundred miles with the power off or memory has been lost due to battery failure, the unit may take 7 1/2 to 15 minutes to acquire satellite data.

To speed up the acquisition process, you can enter a more accurate initial position. Most maps and charts show the latitude and longitude of major cities.

1. Press the **▼** key until the position field is highlighted.
2. Press **ENTER** to begin entry of your position.
- 3 Use the **◀** and **▶** arrow keys to select the character position you want to edit.
4. Use the **▲** and **▼** arrow keys to select the value for each field. All fields must have a value.
5. Press the **ENTER** key to confirm your changes.

When the GPS 45 is acquiring satellites or navigating in the 2D mode, the last known altitude will be used to compute your position. If the altitude shown is off by several hundred feet, enter a corrected altitude manually for greater accuracy.

1. Press the **▼** key until the altitude field is highlighted.
2. Press **ENTER** to begin entry of your altitude.
3. Use the **▲** and **▼** keys to enter a value in each character field, using the **◀** and **▶** keys to move to the next character position.
4. Press the **ENTER** key to confirm the altitude.

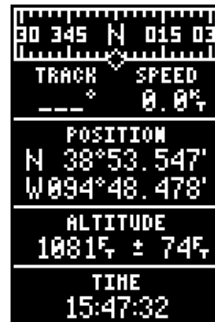

The unit of measure for speed, position and altitude are all user-selectable. To change the default settings for these fields, refer to the navigation setup instructions on page 41.

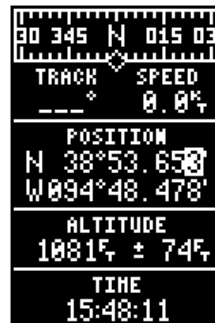

Reference

Marking and Naming Waypoints



Knowing your present position is only part of any navigation equation. You also need to keep track of where you've been and where you are going. Waypoints serve as electronic markers that let you keep track of starting points, destinations, nav aids and any other important position.

The GPS 45 allows you to mark, store and use up to 250 waypoints. A waypoint position can be entered by taking an instant electronic fix or by manually entering a coordinate or range and bearing in reference to an existing waypoint. To mark your present position (make sure you have acquired a satellite position) as a waypoint:

1. Press the **MARK** key to capture your position.

The Mark Position Page appears, showing the captured position and a default 3-digit waypoint name. To change the default position name :

1. Press the **▲** key twice to move the field highlight from the 'save' field to the name field.
2. Press the **ENTER** key to begin entry of your waypoint name.
3. Use the **▲** and **▼** keys to enter a value in the appropriate character field, using the **◀** and **▶** keys to move to each character position.
4. Press **ENTER** to confirm the waypoint name. The field highlight will move to the 'route' field.

If you'd like to add this waypoint to a route:

1. Press the **ENTER** key.
2. Use the **▲** or **▼** keys to enter a route number.
3. Press the **ENTER** key to confirm the route number.
4. Press the **ENTER** key again to save the waypoint.

If you do not want to add this waypoint to a route:

1. Move the field highlight to the 'save' field and press the **ENTER** key.

The GPS 45 has three waypoint submenu pages that let you manage a large number of waypoints quickly and efficiently. The nearest waypoints, waypoint list and waypoint definition pages are accessed through the Menu Page. To select a waypoint submenu page:

1. Press the **PAGE** or **QUIT** key until the Menu Page appears.
2. Use the **▲** and **▼** keys to highlight the waypoint submenu page you want to use.
3. Press **ENTER** to display the submenu page.
4. To return to the Menu Page, press the **PAGE** key.

The nearest waypoints page shows the nine nearest waypoints that are within 100 nautical miles of your present position, with the bearing and range noted for each waypoint. During an emergency or foul weather, the nearest waypoints page can give you a quick reference to the closest points of safety in your area.

The nearest waypoints page will also let you GO TO a selected waypoint or retrieve a waypoint definition page right from the list:

1. Use the **▲** and **▼** keys to highlight a listed waypoint.
2. To select a highlighted nearest waypoint as a destination, press the **GOTO** key.
3. Once the Navigation Page appears, press the **ENTER** key to confirm the selected waypoint as your destination.

To review the waypoint definition page of a selected waypoint from the list:

1. Press the **ENTER** key.

To return to the nearest waypoint page (when the 'done' field is highlighted):

1. Press the **ENTER** key.

MENU		
NEAREST WPTS		
WAYPOINT LIST		
WAYPOINT		
ROUTES		
DIS AND SUM CALC		
MESSAGES		
OPERATION SETUP		
NAVIGATION SETUP		
TRACK LOG SETUP		
MAP SETUP		
I/O SETUP		

NEAREST WPTS		
WAYPNT	BRG	DIS
DOCK	217°	0.00
FUEL	159°	5.90
DIVE	259°	13.8
MAP	303°	18.6
FISH	279°	23.9
----	----	----
----	----	----
----	----	----
----	----	----
----	----	----
----	----	----

NEAREST WPTS		
WAYPNT	BRG	DIS
DOCK	217°	0.00
FUEL	159°	5.90
DIVE	259°	13.8
MAP	303°	18.6
FISH	279°	23.9
----	----	----
----	----	----
----	----	----
----	----	----
----	----	----
----	----	----

```

WAYPOINT LIST
243 EMPTY 7 USED
DIVE
DOCK
FISH
FUEL
GARMIN
HOME
MAP
-----
DELETE ALL WPTS?

```

```

WAYPOINT LIST
243 EMPTY 7 USED
DIVE
DOCK
FISH
FUEL
GARMIN
HOME
MAP
-----
DELETE ALL WPTS?

```

```

DELETE ALL WPTS
WARNING!
all user defined
waypoints and
routes will be
deleted
Are you sure
Yes? or No?

```

The waypoint list page provides you with a complete list of all waypoints currently stored in the GPS 45. The total number of used and free waypoints is indicated above the waypoint list. From the waypoint list page, you can GOTO a selected waypoint, retrieve a waypoint definition page or delete all user-defined waypoints.

1. Use the ▲ and ▼ keys to scroll through the list and select a waypoint.
2. To select a highlighted waypoint as a destination, press the **GOTO** key.
3. Once the Navigation Page appears, press the **ENTER** key to confirm the selected waypoint as your destination.

To review the waypoint definition page of a selected waypoint from the list:

1. Press the **ENTER** key.

To return to the waypoint list page (when the 'done' field highlighted):

1. Press the **ENTER** key.

To delete all user defined waypoints:

1. Use the ▲ or ▼ keys to move the cursor highlight to the 'delete all waypoints' field.
2. Press the **ENTER** key.

A warning page will appear, asking if you are sure you want to delete all user-defined waypoints and routes. If you want to continue and delete:

1. Press the ◀ key to highlight the 'Yes' field.
2. Press the **ENTER** key.
3. Press the **QUIT** key to return to the Menu Page.

If you do not want to delete all waypoints:

1. Press **ENTER** with the 'no' field highlighted.

The last of the three waypoint management pages is the waypoint definition page. This page lets you create new waypoints manually, as well as review and edit existing waypoints.

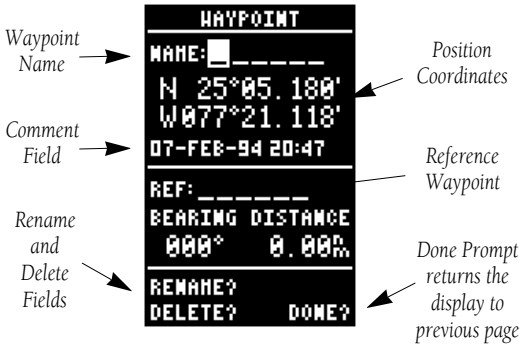

To create a new waypoint manually, you'll need to know its position coordinates or its distance and bearing from an existing waypoint. If you know the position coordinates for your new waypoint:

1. Press the **▼** key to highlight the name field.
2. Press **ENTER** to begin entry of the waypoint name.
3. Use the **▲** and **▼** keys to enter your waypoint name, using the **◀** and **▶** keys to move to the next character position.
4. Press **ENTER** to confirm the waypoint name. The position field will now become highlighted, with the receiver's last known position shown.
5. Press **ENTER** to begin entry of the position.
6. Use the **▲** and **▼** keys to enter your position, using the **◀** and **▶** keys to move to each character field.
7. Press the **ENTER** key to confirm and save your coordinates. The default waypoint comment (UTC date and time of creation) will appear and the highlight will move to the 'done field.
8. Press the **ENTER** key to return to the Menu Page.

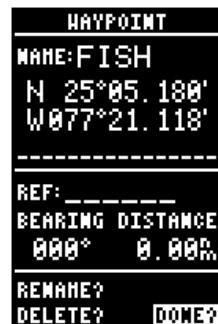
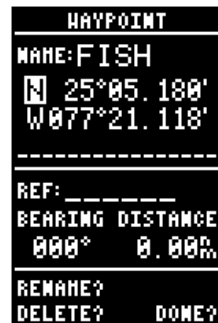
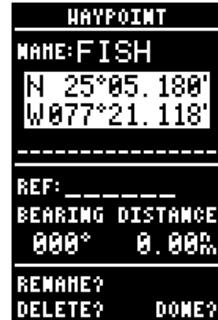

Reference

Reference Waypoints

To create a new waypoint manually without knowing its position coordinates, you'll need to enter its bearing and distance from an existing waypoint. The GPS 45 will then calculate the position coordinates for you.

```
WAYPOINT
NAME: ANCHOR
N 25°05.180'
W 077°21.118'
08-FEB-94 08:55
REF:
BEARING DISTANCE
000° 0.00%
RENAME?
DELETE? DONE?
```

Waypoint
Name

Reference
Waypoint

Bearing
from
Reference
Waypoint

```
WAYPOINT
NAME: ANCHOR
N 25°05.180'
W 077°21.118'
-----
REF:
BEARING DISTANCE
000° 0.00%
RENAME?
DELETE? DONE?
```

Position
Coordinates
are calculated
after entering
reference data

Distance
from
Reference
Waypoint

```
WAYPOINT
NAME: ANCHOR
N 25°05.180'
W 077°21.118'
08-FEB-94 08:55
REF: FISH
BEARING DISTANCE
260° 05.50%
RENAME?
DELETE? DONE?
```

```
WAYPOINT
NAME: ANCHOR
N 25°03.634'
W 077°26.934'
08-FEB-94 08:55
REF: FISH
BEARING DISTANCE
260° 5.50%
RENAME?
DELETE? DONE?
```

1. Press **▼** until the name field is highlighted.
2. Press **ENTER** to begin entry of the waypoint name.
3. Enter the name of your new waypoint.
4. Press the **ENTER** key to confirm the waypoint name. The position field will now become highlighted, with the receiver's last known position shown.
5. Press the **▼** key to move the cursor highlight to the reference field.
6. Press **ENTER** to begin entry of reference waypoint.
7. Use the **▲** and **▼** keys to enter the name of your reference waypoint, using the **◀** and **▶** keys to move to each character field.
8. Press the **ENTER** key to confirm your entry.
9. Enter the bearing and distance of your new waypoint from the reference waypoint. Remember to use the **ENTER** key to begin entry and confirm each field. The coordinates will be calculated and saved for your new waypoint.
10. Press the **ENTER** key (when the 'done' field is highlighted) to return to the Menu Page.

From the waypoint definition page, you can also review and change any stored waypoint's name, position coordinates, comment field or reference waypoint at any time. The waypoint definition page is also used to delete individual waypoints.

To change a waypoint's position coordinates or reference waypoint:

1. Use the ▲ and ▼ keys to highlight the field you want to edit.
2. Press **ENTER** to begin entry in the selected field.
3. Enter your new data.
4. Press the **ENTER** key to confirm your changes.

Each waypoint stored in the GPS 45 has a user-defined 16 character comment field. The default comment is the UTC date and time of the waypoint's creation. To change or add a comment:

1. Use the ▲ and ▼ keys to highlight the comment field.
2. Press **ENTER** to begin entry of your comment.
3. Enter your new comment.
4. Press the **ENTER** key to confirm your changes.

The rename and delete function fields are located at the bottom of the screen, to the left of the 'DONE' prompt. To select one of these functions, you need to use the ◀ key to move the cursor highlight out of its main scrolling sequence. To rename a stored waypoint:

1. Use the ◀ and ▶ keys to highlight the 'rename' field.
2. Press the **ENTER** key to activate the rename page.
3. Enter the new waypoint name and press **ENTER**.
4. Press the **ENTER** key to confirm your changes.

```

WAYPOINT
NAME: ANCHOR
N 25°03.634'
W 077°26.934'
SAND_BOTTO[ ]-----
REF: FISH
BEARING DISTANCE
260° 5.50%
RENAME?
DELETE? DONE?
  
```

```

WAYPOINT
NAME: ANCHOR
N 25°03.634'
W 077°26.934'
SAND BOTTON
REF: FISH
BEARING DISTANCE
260° 5.50%
RENAME?
DELETE? DONE?
  
```

```

RENAME WAYPOINT
From
ANCHOR
To:
RFT-UP
Are you sure
Yes? or No?
  
```

Reference

Deleting Waypoints



To delete a stored waypoint:

1. Use the **◀** key to move the cursor highlight from the 'DONE' prompt to the 'delete' field.
2. Press the **ENTER** key to activate the delete page.
3. A warning message will appear, asking you to confirm your deletion.
4. Press the **◀** key to select the 'YES' prompt.
5. Press the **ENTER** key to delete the waypoint and return to the waypoint page.



Waypoints that are part of an active or stored route cannot be deleted. You must first go to the route page and remove the waypoint from all routes. See pages 31 and 32 for complete instructions on editing routes.

GOTO
Function

The GPS 45's GOTO function lets you choose any stored waypoint as a destination and quickly set a course from your present position. Once the GOTO function has been activated, the Navigation Page will provide you with graphic steering guidance to your destination. To activate the GOTO function:

1. Press the **GOTO** key.
2. The Navigation Page will appear with the waypoint field ready to accept changes.
3. Enter your destination waypoint.
4. Press the **ENTER** key to confirm that you want to navigate to the displayed waypoint.

You can also quickly activate the GOTO function from any other page by simply highlighting a waypoint and pressing the **GOTO** key.

Another time-saving function of the GPS 45 that you may have noticed when entering waypoint names is the waypoint scanning feature. As you enter waypoint characters, the screen will automatically display the first numerical or alphabetical match of the character you have entered. This will save you from always entering an entire waypoint name. To use the scan feature when the waypoint field is highlighted:

1. Press the **◀** key to clear the name field.
2. Use the **▲** and **▼** keys to scroll through your waypoints.
3. If you have more than one waypoint that begins with the same letter or number, you must use the **▶** key to move to the next character positions as needed. Only the first character match is listed for each character set.
4. Once you've found the desired waypoint, press **ENTER**.

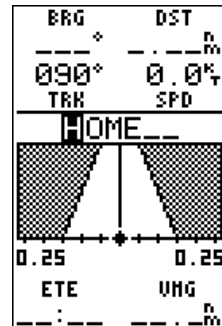
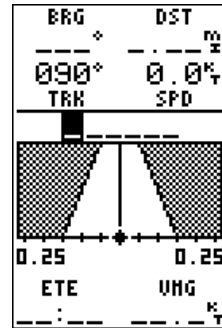

To cancel an active GOTO from any page, press the GOTO key. Next, press the left arrow key, and confirm your cancellation by pressing the enter key. This will stop continued steering guidance along the original GOTO desired track.

Reference

MOB Function

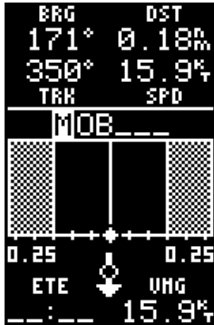

Marking an MOB

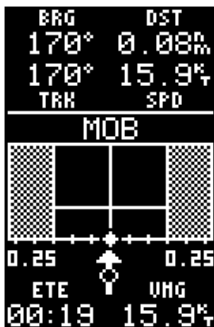

As you approach a waypoint, a horizontal 'finish line' will move toward the bottom of the highway.

When the finish line reaches the course deviation scale, you've arrived at your destination.

The GPS 45's man overboard function (MOB) lets you simultaneously mark and set a course to a position for quick response in emergency situations. To activate the MOB mode:

1. Press the **GOTO** key twice.
2. The Navigation Page will appear with the default GOTO waypoint 'MOB' as the destination.
3. Press the **ENTER** key to confirm the MOB entry.

The Navigation Page will now guide you to the MOB waypoint position.

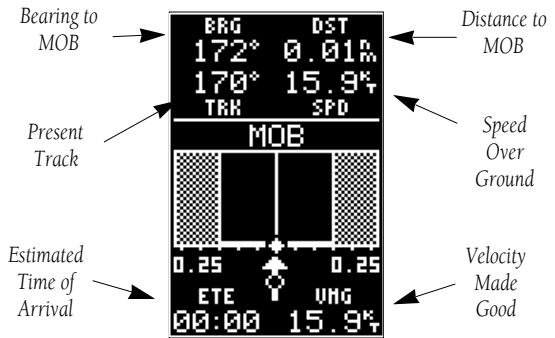

The graphic 'highway' provides visual steering guidance to the MOB waypoint. The moving arrow just below the course deviation scale always points to your selected waypoint relative to the direction you are moving.

Your present position is represented by the diamond in the center of the course deviation scale. The line down the middle of the highway is your desired track. As you head toward a waypoint, the highway will move indicating the direction and distance you are off course, relative to the position diamond on the CDI scale. To keep your vessel on course, steer toward the center of the highway.

If you want to save the MOB waypoint, be sure to rename it, as it will be overwritten the next time a MOB is executed.

The GPS 45's route navigation feature lets you plan and navigate a course from one place to another using a set of pre-defined waypoints. Routes are often used when it's not practical, safe or possible to navigate a direct course to a particular destination.

Routes are broken down and navigated in smaller segments called 'legs'. The waypoint you are going to in a leg is called the 'active to' waypoint, and the waypoint immediately behind you is called the 'active from' waypoint. The line between the 'active to' and the 'active from' waypoint is called the 'active leg'.

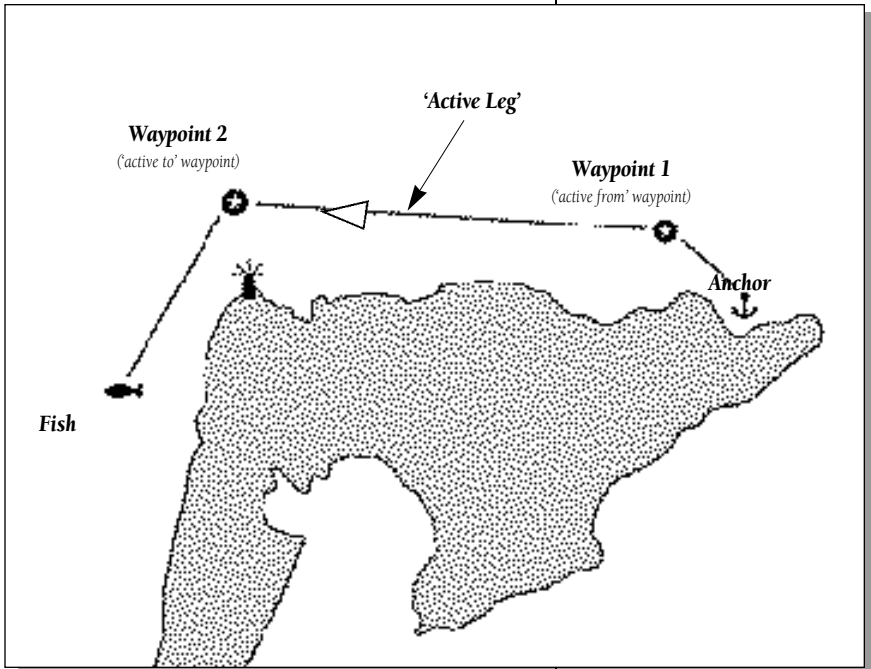

When you activate a route with the GPS 45, it will automatically select the route leg closest to your position as the active leg. As you pass a waypoint in your route, the unit will select the next waypoint as the 'active to' waypoint.



If you're heading out on the water without a planned route to navigate, the GPS 45 route feature can still provide a helping hand back home.

Create a series of waypoints with the mark key and save them to an open route from the Mark Position Page.

When you are ready to head back to port, simply activate the route you created in inverted order (see page 30).

This method is especially useful when you're in unfamiliar waters or you are simply running out of daylight.

The GPS 45 lets you create and store up to 20 routes of 30 waypoints each. Routes are created, copied and edited through the route definition page, which is accessed through the Menu Page. To select the route definition page:

1. Press **PAGE** until the Menu Page appears.
2. Use the **▲** and **▼** keys to highlight the 'routes' submenu page.
3. Press the **ENTER** key to display the routes page.
4. To return to the Menu Page, press **PAGE**.

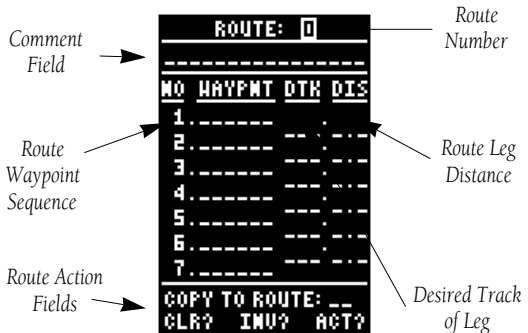

The route number field is displayed at the top of the page, with a 16 character user comment below. If no user comment is entered, the field will display the first and last waypoint in the route. The waypoint list in the middle of the page accepts up to 30 waypoints for each route, with fields for desired track and distance between legs.

Below the waypoint list are the route page function fields which let you copy, clear, invert or activate the displayed route. Routes 1-19 are used as storage routes, with route 0 always serving as the active route you are navigating. If you want to save a route currently in route 0, be sure to copy it to another open route, as it will be overwritten by the next route activation.

To create a route in the GPS 45:

1. Press **ENTER** to begin route number selection.
2. Use the **▲** or **▼** key to enter a route number.
3. Press the **ENTER** key to confirm the route number.
4. Press **ENTER** to begin entry of a route comment. (Note that the default (first and last waypoint) comment will only appear if the comment field is blank).
5. Enter your comment and press the **ENTER** key.
6. Highlight the No. 1 waypoint field and press **ENTER**.
7. Enter the name of the first waypoint of your route and press **ENTER**.
8. Continue entering the rest of your waypoints in order, using the **ENTER** key to start and confirm each field entry. The list will automatically scroll down as needed to enter up to 30 waypoints.
9. After you have finished entering all your waypoints, press **PAGE** to return to the Menu Page.

The route definition page is also used to copy a route to another route number. This feature is useful when you make changes to the active route and want to save the new route and the original route. To copy a route:

1. Press **ENTER** to begin route number selection.
2. Enter the route number to be copied and press **ENTER**.
3. Move the field highlight to the 'copy' field and press **ENTER**.
4. Scroll through the available routes and select a destination route number. Only open routes will be available as choices. Press the **ENTER** key to copy the route.
5. Press the **PAGE** key to return to the Menu Page.

```

ROUTE: 1
-----
NO WAYPNT DTK DIS
1. _____
2. _____
3. _____
4. _____
5. _____
6. _____
7. _____
COPY TO ROUTE: __
CLR? INU? ACT?
  
```

```

ROUTE: 1
DOCK TO FISH
-----
NO WAYPNT DTK DIS
1. DOCK      159' 5.9
2. FUEL     339' 5.9
3. FISH
4. DIVE__
5. _____
6. _____
7. _____
COPY TO ROUTE: __
CLR? INU? ACT?
  
```

```

ROUTE: 1
DOCK TO DIVE
-----
NO WAYPNT DTK DIS
1. DOCK      159' 5.9
2. FUEL     339' 5.9
3. FISH     259' 14
4. DIVE
5. _____
6. _____
7. _____
COPY TO ROUTE: ??
CLR? INU? ACT?
  
```

Clearing and Activating Routes

ROUTE: 1			
DOCK TO DIVE			
NO	WAYPNT	DTK	DIS
1.	DOCK	159'	5.9
2.	FUEL	339'	5.9
3.	FISH	259'	14
4.	DIVE	---	---
5.	-----	---	---
6.	-----	---	---
7.	-----	---	---
COPY TO ROUTE: __			
CLR?	INV?	ACT?	

CLEAR ROUTE

WARNING!

all waypoints
will be removed
from this route

Are you sure
Yes? or No?

ROUTE: 1			
DOCK TO DIVE			
NO	WAYPNT	DTK	DIS
1.	DOCK	159'	5.9
2.	FUEL	339'	5.9
3.	FISH	259'	14
4.	DIVE	---	---
5.	-----	---	---
6.	-----	---	---
7.	-----	---	---
COPY TO ROUTE: __			
CLR?	INV?	ACT?	

To clear a route from memory:

1. Press **ENTER** to begin entry of the route number.
2. Enter the route number and press **ENTER**.
3. Select the 'clear' field and press **ENTER**.

The clear route warning will appear, asking you to confirm that you want to remove all waypoints from the route.

1. Highlight the 'yes' field with the **◀** key.
2. Press **ENTER** to confirm your action.
3. Press **PAGE** to return to the Menu Page.

After a route has been entered in the GPS 45, it can be activated in its defined sequence or inverted from the route definition page. The process of activating or inverting a stored route takes a storage route (routes 1-19) and copies it into the active route (route 0) for navigation. The storage route is now no longer needed and will be retained in its original format under its existing route number.

This system allows you to have an active route that you may edit during navigation and save as an entirely new route from the original. You will have to copy the active route to an unused storage route to save it, since new route activation overwrites route 0. To activate a route:

1. Select the route definition page and press the **ENTER** key to activate the route number field.
2. Enter the route number to be activated and press the **ENTER** key.
3. Move the field highlight to the 'act' field and press **ENTER**.

Inverting a route allows you to navigate route legs in reverse order, without editing the original route. To activate a route in inverted order:

1. Follow the same steps as above, but select the 'inv' command field and press the **ENTER** key.

Reference

Editing Routes and On-Route GOTOs

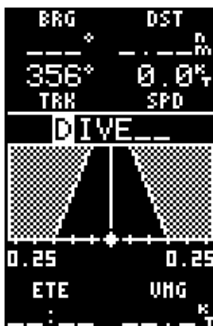
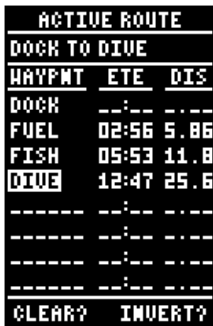

Once you've selected a waypoint from the route list, choose a menu function:

1. To review the definition page for the waypoint, highlight the 'review' field and press **ENTER**.
2. To add a new waypoint that precedes the selected waypoint, highlight the 'insert' field and press the **ENTER** key.
3. To remove the selected waypoint, highlight the 'remove' field and press the **ENTER** key.
4. To replace the selected waypoint with a new waypoint, highlight the 'change' field and press the **ENTER** key.

Use the waypoint editing instructions described earlier (see page 29) for creating a route to complete your changes. If you are editing the active route (route 0), copy your new route version to an empty route to save it, as the active route will be overwritten by a new route activation.

If you add, delete or change the first or last waypoint of a route, the default comment (first and last waypoint) will automatically be updated after your changes.

At the beginning of the route section, we mentioned that the GPS 45 will automatically select the route leg closest to your position as the active leg. This will give you steering guidance to the desired track of the active leg. If you would prefer to steer directly towards a route waypoint, you can perform an 'on-route GOTO' right from the active route page.

1. Use the **▲** and **▼** keys to highlight the desired route waypoint and press the **GOTO** key.
2. Once the Navigation Page appears, press **ENTER** to confirm the on-route GOTO waypoint.

The GPS 45 features a powerful moving map display that can do much more than just plot your course and route. The Map Page also provides you with a moving map cursor that will let you pan ahead to nearby waypoints, determine the distance and bearing to any map position and mark new waypoints while you navigate.

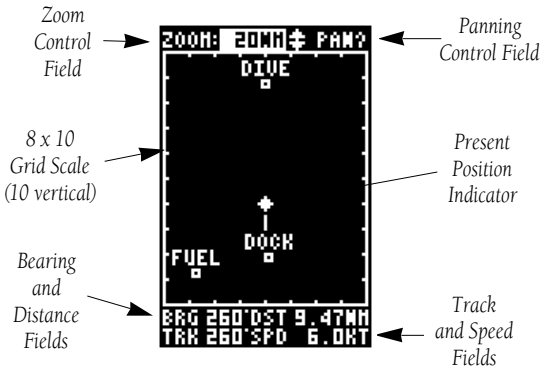

The Map Page can be broken down into three main sections:

The zoom function and panning control fields are located at the top of the screen. There are 12 selectable zoom ranges from 0.2 to 320 miles or 0.5 to 600 km, measured vertically.

The map portion of the page is bordered by an 8 x 10 grid to help you estimate distances based on the map scale you are using. Your present position is indicated by a position diamond, with your track and/or route displayed as a solid line. Nearby waypoints are represented as squares, with the waypoint name also listed. You may select which of these features are shown through the map setup submenu page (see page 43 for more information).

The last fields directly below the map show your bearing and distance to one of three selectable destinations: an active destination waypoint; a highlighted on-screen waypoint; or to the panning target crosshair. Your current track and speed are displayed just below the bearing and distance fields.

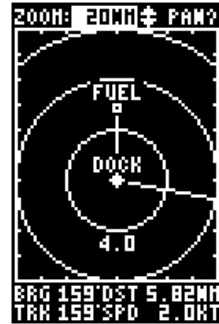

The GPS 45 has on-screen range rings to help you estimate distances relative to your present position. The value of each ring is determined by the current zoom scale.

The distance value of each ring is equal to 1/5th of the current zoom range, with the interval of each ring noted below the first range ring.

To turn the range ring display on or off (the default setting is off), see the map setup instructions on page 43.

Reference

Moving Map: Zooming and Panning

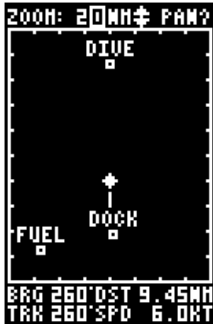

There are three main functions you can perform from the Map Page— zooming, pointing and panning. Each of these functions has its own ‘field’, which may be selected and activated for use.

Whenever the Map Page first appears, the zoom field (at the top left) is always selected. The Map Page has 12 map scales which are selected through the zoom function field. To select a zoom scale:

1. Press ◀ or ▶ to highlight the zoom field.
2. Press the **ENTER** key to begin range selection.
3. Use the ▲ or ▼ keys to scroll through and find the desired range scale.
4. Press **ENTER** to confirm your selection.

The second function field on the Map Page is the pan field, located at the top right of the screen. The pan function allows you to move the map with the four arrow keys to view areas outside the current map. To activate the pan function:

1. From the zoom field, use the ▶ key to highlight the pan field.
2. Press the **ENTER** key to activate the pan function.
3. Use the arrow keys to move the map in any direction. .

As you begin to move the map, a crosshair will appear. This crosshair will now serve as a target marker for the moving map. The distance and bearing to destination will now be replaced by the distance and bearing from your present position to the target crosshair.

As you pan around the moving map display, you’ll notice that the target crosshair will ‘snap’ to on-screen waypoints and highlight the waypoint name. Once a waypoint name is highlighted, you can review its waypoint definition page or execute a GOTO function right from the Map Page.

Moving Map:
On-Screen
Waypoints

To review the definition page for a waypoint highlighted in the map field:

1. Press the **ENTER** key.
2. To return to the Map Page, press **ENTER**.

To GOTO a waypoint highlighted in the map field:

1. Press the **GOTO** key.
2. Press the **ENTER** key to confirm the destination.
3. To return to the Map Page, press the **QUIT** key.

To stop the panning function and return to your present position:

1. Press the **QUIT** key.

The last field on the Map Page is the map itself. From the zoom or pan fields, the cursor highlight may be moved into the map display by pressing the down arrow key. The arrow keys will now move the highlight through the map and 'point' at on-screen waypoints. To point at a displayed waypoint:

1. Use the arrow keys to move the cursor highlight from the zoom field into the map field.
2. Once you are in the map field, use the four arrow keys to scroll through on-screen waypoints. The arrow key you use will determine the direction of your scroll. Once you have scrolled through all the waypoints, the cursor will move back to the zoom or pan function field.

Once a waypoint has been selected in the map field, its distance and bearing from your present position will be displayed in the destination field. You can also review its waypoint definition page or select it as a GOTO destination by following the same steps outlined above for waypoints highlighted on the map field.

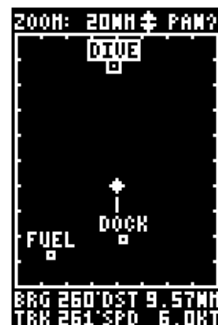
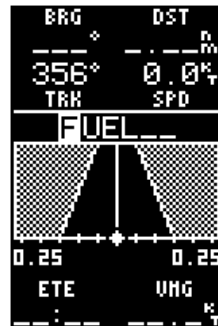

Reference

Map Page: Advanced Zooming and Panning

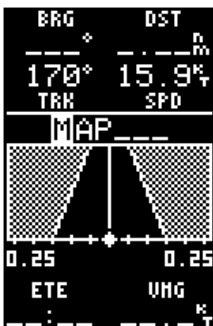

One of the benefits of a moving map display is being able to pan to different map areas and see what's out there. To get the most out of panning, you'll need to be able to zoom in and out while you're panning. This lets you move the map at a faster speed and zoom in for waypoint details. Once the pan function is activated, the cursor highlight moves back to the zoom field. To adjust the zoom range while panning:

1. Press the **ENTER** key to begin range selection.
2. Use the **▲** and **▼** keys to select the desired zoom range.
3. Press **ENTER** to return to normal panning mode.

During panning, the crosshair represents a target position right on the moving map, with the range and bearing to the target displayed at the bottom of the screen. You can also use the target crosshair to mark a new waypoint position or as a GOTO destination right from the map field. To mark the target crosshair position as a new waypoint:

1. Press the **MARK** key to capture the position.
2. Enter a new name and route number if you wish.
3. Press the **ENTER** key to return to the Map Page.

You can also use the target crosshair as an instant GOTO destination. Similar to the MOB mode, this function will mark and instantly set a course for a new waypoint called 'MAP'. To GOTO the target crosshair:

1. Press the **GOTO** key to capture the position.
2. Press the **ENTER** key to confirm the MAP GOTO.
3. Press **QUIT** to return to the Map Page.

If you want to save the MAP waypoint, be sure to rename it, as it will be overwritten the next time a map GOTO is executed.

The GPS 45 Menu Page provides access to submenu pages that are used to select and customize operation and navigation setup. The 11 submenus are divided into categories by function. The waypoint and route management submenus are discussed in their own respective sections. We'll now address the rest of the submenus in the order they appear on the Menu Page. To select a submenu page from the Menu Page:

1. Highlight the submenu page you want to view.
2. Press the **ENTER** key to display the submenu page.
3. To return to the Menu Page, press the **PAGE** key.

The distance and sun calculation page will give you the distance and bearing between any two waypoints and calculate the sunrise and sunset (in local time) at a destination waypoint for a particular date. To perform a distance and sun calculation:

1. Highlight the 'from' field and enter the desired waypoint. Press **ENTER** to move to the next field.
2. Highlight the 'to' field and enter the destination waypoint. Press the **ENTER** key to calculate the range and bearing to the destination waypoint.
3. Highlight the 'date' field and enter the date for your destination. Press the **ENTER** key to display the sun information.

The messages page displays all current messages in the GPS 45. There are two types of messages: temporary alerts (eg. approaching a waypoint) and condition alerts (eg. battery power is low). All messages are initially indicated by a flashing on-screen indicator. After a temporary alert has been viewed, it is cleared from the message page. Condition alerts are displayed on the messages page until the condition has been resolved. To view the messages page:

1. Move the field highlight to the 'messages' field and press **PAGE**.

```

MENU
-----
NEAREST WPTS
WAYPOINT LIST
WAYPOINT
-----
ROUTES
DIS AND SUN CAL
MESSAGES
-----
OPERATION SETUP
NAVIGATION SETUP
TRACK LOG SETUP
MAP SETUP
I/O SETUP
  
```

```

DIS AND SUN CAL
-----
FROM: ANCHOR
TO: STRIKE
BEARING DISTANCE
153° 25.8%
-----
DATE: 18 JAN 94
SUNRISE 17:34:39
SUNSET 03:23:36
(CAT DESTINATION)
  
```

```

MESSAGES
-----
Route Waypoint
Can't be Deleted
-----
PRESS PAGE
  
```

```

OPERATION SETUP
MODE:
Normal?
DATE 18 JAN 94
TIME 16:30:00
OFFSET: +04:00
CONTRAST:
BACKLIGHT TIME:
30 seconds
TONE:MSG Only
  
```

```

OPERATION SETUP
MODE:
Normal
DATE 18 JAN 94
TIME 12:31:28
OFFSET: +00:00
CONTRAST:
BACKLIGHT TIME:
30 seconds
TONE:MSG Only
  
```

```

OPERATION SETUP
MODE:
Normal
DATE 18 JAN 94
TIME 12:31:44
OFFSET: -00:00
CONTRAST:
BACKLIGHT TIME:
30 seconds
TONE:MSG Only
  
```

The remaining submenu selections on the Menu Page are grouped together as setup pages. The first setup page is the operation setup page, which is used to select the operating mode, time offset and screen and tone preferences.

The GPS 45 has four available operating modes:

Normal Mode operates the unit at maximum performance, and should provide a battery life of 10 hours on alkaline batteries.

Battery Saver Mode is suitable for most applications, and extends battery life to up to 20 hours on alkaline batteries.

Simulator Mode allows you to operate the unit without acquiring satellites, and is ideal for practicing or entering waypoints and routes while at home.

AutoLocate™ Mode forces the receiver to search for a new set of satellites in situations where you have moved more than 300 miles from the unit's last known position.

To select an operating mode:

1. Move the field highlight to the 'mode' field and press the **ENTER** key.
2. Use the **▲** and **▼** keys to choose the desired mode and press **ENTER**.

The date and time field is located directly below the mode field. The date and time are calculated from satellites and *cannot* be edited. Because the time shown is UTC time, you will need to enter a time offset to display the correct local time for your area. To determine the time offset for your area, note your current position and refer to the chart on appendix C. To enter the time offset:

1. Move the field highlight to the 'offset' field and press the **ENTER** key.
2. Enter the time offset for your longitude and press **ENTER**. Remember to select a positive or negative indicator for your offset.

The GPS 45 features adjustable screen contrast for optimum viewing in any condition. The screen contrast is set by using an on-screen bar scale. To set the screen contrast:

1. Move the field highlight to the 'contrast' field and press the **ENTER** key.
2. Use the **◀** and **▶** keys to adjust the bar scale for the desired contrast and press the **ENTER** key.

The screen backlight timer is adjustable for 0, 15, 30, 60, 120 and 240 seconds. The '0' setting will keep the screen backlighting on as long as the unit is on. Whenever screen backlighting is on, a light bulb icon will appear on the Status Page. To set the backlight timer:

1. Move the field highlight to the 'backlight time' field and press the **ENTER** key.
2. Use the **▲** and **▼** keys to toggle through and select the desired setting. Confirm the setting by pressing the **ENTER** key.
3. To turn backlighting on and off, press **☼**.

The last available field on the operation setup page is the tone field. This field lets you specify an audible tone for message alerts and keystroke confirmation. The tone may be set to sound for messages only, messages and keystrokes or no sound at all. To select a tone setting:

1. Move the field highlight to the 'tone' field and press the **ENTER** key.
2. Use the **▲** and **▼** keys to toggle through and select the desired setting. Confirm the setting by pressing the **ENTER** key.

We've now gone through the operation setup submenu and its various settings. To return to the Menu Page:

1. Press the **PAGE** key.



```

OPERATION SETUP
MODE:
Normal
DATE 18 JAN 94
TIME 06:32:05
OFFSET: -06:00
CONTRAST:
[Bar Scale]
BACKLIGHT TIME:
30 seconds
TONE:MSG Only
  
```



```

OPERATION SETUP
MODE:
Normal
DATE 18 JAN 94
TIME 06:32:15
OFFSET: -06:00
CONTRAST:
[Bar Scale]
BACKLIGHT TIME:
30 seconds
TONE:MSG Only
  
```



```

OPERATION SETUP
MODE:
Normal
DATE 18 JAN 94
TIME 06:32:26
OFFSET: -06:00
CONTRAST:
[Bar Scale]
BACKLIGHT TIME:
30 seconds
TONE:MSG Only
  
```

```

NAVIGATION SETUP
POSITION FORMAT:
hddd°mm. mmm'
MAP DATUM:
WGS 84
CDI SCALE: ±0.25
UNITS: Nautical
HEADING:
Auto Mag E004
    
```

The GPS 45 comes with the latitude and longitude position format and WGS 84 map datum as the default settings.

The WGS 84 map datum is a worldwide datum that's suitable for use with most government charts. Only change the map datum if the charts you are using specify a different map datum in the legend.

WARNING!

Using the wrong datum can seriously effect the accuracy of your GPS. Always set the GPS to the same datum indicated on the charts you are currently using.

The navigation setup page is used to select units of measurement for position format, map datum, CDI scale, and distance, speed and heading information.

The default position setting for the GPS 45 is latitude and longitude in degrees and minutes (hddd°mm.mmm'). You may also select degrees, minutes and seconds (hddd°mm'ss.s"); degrees only (hddd.dddd°); UTM coordinates; or British, Irish or Swiss Grid formats. To select a format:

1. Move the field highlight to the 'position format' field and press the **ENTER** key.
2. Use the **▲** and **▼** keys to select the desired setting. Confirm the setting by pressing **ENTER**.

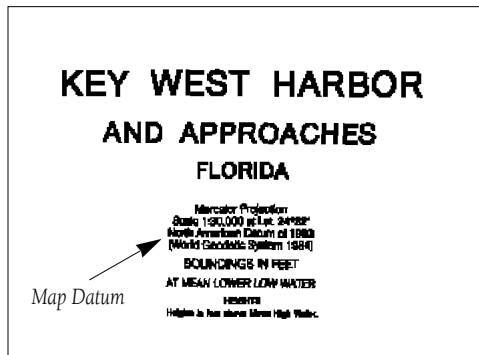

The map datum field is located just below the position format field, and comes with a WGS 84 default setting. Although 102 total map datums are available for use (see the map datum listing in appendix D), you should only change the datum if you are using charts that specify a different datum than WGS 84. To enter a different map datum:

1. Move the field highlight to the 'datum' field and press the **ENTER** key.
2. Use the **▲** and **▼** keys to toggle through and select the desired setting. Confirm the setting by pressing the **ENTER** key.

The course deviation indicator (CDI) scale definition field lets you select the +/- range of the CDI bar scale. Three scales are available: +/- 0.25, 1.25 and 5.0 miles or kilometers, with 0.25 being the default setting. To enter a CDI scale setting:

1. Highlight the 'CDI scale' field and press **ENTER**.
2. Use the **▲** and **▼** keys to select the desired CDI scale setting.
3. Press the **ENTER** key to confirm the selection.

The GPS 45 lets you select nautical (default), statute or metric units of measure for all speed and distance fields. To change the unit of measure:

1. Highlight the 'units' field and press the **ENTER** key.
2. Use the **▲** and **▼** keys to select the desired unit of measure.
3. Press the **ENTER** key to confirm the selection.

The GPS 45's heading information can be displayed referencing magnetic north (automatic or user-defined), true north or calculated grid headings. The default setting is automatic magnetic north, which is suitable for most applications. To select a reference:

1. Highlight the heading field and press **ENTER**.
2. Use the **▲** and **▼** keys to select the desired heading preference.
3. Press the **ENTER** key to confirm the selection.

To enter a magnetic heading:

1. Select the 'user mag' heading and press **ENTER**.
2. Use the **▲** and **▼** keys to enter the degrees of magnetic variation.
3. Press the **ENTER** key to confirm the magnetic variation value.

```

NAVIGATION SETUP
POSITION FORMAT:
hddd°mm. mmm'
MAP DATUM:
WGS 84
CDI SCALE: ±0.25
UNITS: Nautical
HEADING:
Auto Mag E004
  
```

```

NAVIGATION SETUP
POSITION FORMAT:
hddd°mm. mmm'
MAP DATUM:
WGS 84
CDI SCALE: ±0.25
UNITS: Nautical
HEADING:
Auto Mag E004
  
```

```

NAVIGATION SETUP
POSITION FORMAT:
hddd°mm. mmm'
MAP DATUM:
WGS 84
CDI SCALE: ±0.25
UNITS: Nautical
HEADING:
User Mag: E004
  
```

```

TRACK LOG SETUP
RECORD TRACK: Yes
CRITERIA:
Time Interval:
00:00:00
MEMORY USED 0%
5 OF 768 POINTS
CLEAR TRACK LOG?
    
```

```

CLEAR TRACK LOG

WARNING!
all track log
points will be
deleted

Are you sure
Yes? or No?
    
```

```

MAP SETUP
ORIENTATION:
North Up
PLOTTED ITEMS
RINGS: No
ROUTE: Yes
NEAREST: Yes
NAMES: Yes
TRACK LOG: 500
    
```

The track log setup page lets you manage the GPS 45's tracking data. From this page, you can select whether or not to record a track and define how it is recorded. To turn the track log on or off:

1. Highlight the 'record track' field and press **ENTER**.
2. Select 'yes' or 'no' and press **ENTER**.

The stored track criteria determines how often positions are stored in the track log. The default setting is automatic, which stores track based on resolution. This setting gives you the most efficient use of track memory. To change the criteria to record points based upon a specific time interval:

1. Highlight the 'criteria' field and press **ENTER**.
2. Use the **▲** or **▼** key to select 'time interval' and press **ENTER**.
3. Press **ENTER** to begin entry of the interval.
4. Enter a value in hours, minutes and seconds in the field and press the **ENTER** key.

The rest of the track log setup page displays the percentage of available memory currently used to store track log data and a function field to clear the track log memory. To clear the track log:

1. Highlight 'clear track log?' and press **ENTER**.
2. A warning page will appear, asking you to confirm your actions. Use the **◀** key to move the field highlight to the 'yes' field and press **ENTER**.

The map setup page lets you select map orientation and specify what items are displayed. The map may be oriented to north up, the direction of current travel (track up) or the direction of an active route leg (desired track up). The default setting is track up. To change the map orientation:

1. Highlight the 'orientation' field and press **ENTER**.
2. Use the **▲** and **▼** keys to toggle through and select the desired setting and press **ENTER**.

The rest of the map setup page lets you specify what items are displayed or plotted on the Map Page. The first 4 plot items may be turned on or off by selecting 'yes' or 'no' in the appropriate field:

- The 'rings' selection will display the 3 present position range rings on the map.
- The 'route' selection will plot the straight leg lines between waypoints of an active route and display all route waypoint names.
- The 'nearest' selection will display the nine nearest waypoints to your present position (not to the target cursor on the map).
- The 'names' selection will display the waypoint name for the nine nearest waypoints.

To turn a plotted item on or off:

1. Highlight the confirmation (yes or no) field for the plotted item and press **ENTER**.
2. Use the **▲** and **▼** keys to select 'yes' or 'no' and press the **ENTER** key.

The track log sets the number of points the unit will attempt to plot. The maximum setting is 768 points. Once you've reached the maximum number of track points, the older points will be lost as new points are added. To enter a log setting:

1. Highlight to the 'track log' field and press **ENTER**.
2. Enter a value in the 3-digit field and press **ENTER**. If you do not want to display a track, enter '000'.

The last GPS 45 setup page is the I/O setup page. This page lets you specify the interfacing formats for connecting external devices. There are five I/O options available: GRMN/GRMN, None/None, None/NMEA, RTCM/None, and RTCM/NMEA.

Each designation lists the input format first, followed by the output format. To select I/O format:

1. Highlight the I/O field and press **ENTER**.
2. Use the **▲** and **▼** keys to toggle through and select the desired setting and press **ENTER**.

```

MAP SETUP
-----
ORIENTATION:
North Up
-----
PLOTTED ITEMS
RINGS:      Yes
ROUTE:      Yes
NEAREST:    Yes
NAMES:      Yes
TRACK LOG:  500
  
```

```

I/O SETUP
-----
GRMN/GRMN
HOST
WAITING...

___ of ___
PACKETS
  
```

```

I/O SETUP
-----
NONE/NMEA?
HOST
WAITING...

___ of ___
PACKETS
  
```

Reference

I/O and DGPS Setup

```
I/O SETUP
NONE/NMEA
NMEA 0183 2.0
4800 baud
```

```
I/O SETUP
RTCM/NMEA
NMEA 0183 2.0
4800 baud
-----
BEACON RECEIVER
FREQ: 304.0KHz
RATE: 25bps
DIST: ---.0%
SNR: 0dB
Tuning
```

```
I/O SETUP
RTCM/NMEA
NMEA 0183 2.0
4800 baud
-----
BEACON RECEIVER
FREQ: 304.0KHz
RATE: 25bps
DIST: 35.8%
SNR: 30dB
Receiving
```

The GRMN/GRMN setting is a proprietary format that lets you exchange information such as waypoints, routes and track logs between two GPS 45s or a PC with an optional GARMIN PC kit. During data transfer, the number of packets being exchanged will be displayed on screen. To select a transfer option:

1. Highlight the 'host' field and press **ENTER**.
2. Use the **▲** and **▼** keys to select the desired setting and press **ENTER**.

To disable all GPS 45 interfacing capabilities, select the None/None setting. If you want to output NMEA data to compatible external devices without any differential input capability, select the None/NMEA setting.

Once a NMEA output setting has been selected (with or without RTCM input), the NMEA field will become highlighted. To choose an NMEA format (0180, 0182 or 0183 version 1.5 or 2.0):

1. Press **ENTER** to begin a NMEA selection.
2. Use the **▲** and **▼** keys to select the desired setting and press **ENTER**.
3. The baud rate will be selected automatically.

The last two format settings allow the GPS 45 to accept RTCM DGPS corrections in RTCM 104 version 2.0 format. The RTCM/NONE format will allow connection to any manually tuned beacon receiver with the proper output interface, with the baud rate selectable from the GPS 45.

The RTCM/NMEA selection controls the GARMIN GBR-21 beacon receiver. Once a RTCM setting has been selected, the GPS 45 will automatically try to tune the last frequency and bit rate you selected or will switch to the default frequency of 304.0 kHz with a bit rate of 100 bps if no previous beacon has been tuned. You may also enter your own frequency and bit rate if desired.

To enter a DGPS beacon frequency:

1. Highlight the 'freq' field and press **ENTER**.
2. Enter the desired frequency and press **ENTER**.
3. Highlight the 'rate' field and press **ENTER**.
4. Use the **▲** and **▼** keys to select the desired transmission rate.
5. Press the **ENTER** key to confirm your entry.

When the GPS 45 is receiving DGPS corrections from the GBR-21, the 'beacon receiver' section of the I/O setup page will display the beacon frequency and signal strength, as well as the distance from the transmitter to the beacon receiver.

At the bottom of the beacon receiver field, a status message will constantly keep you informed of DGPS activity:

- A 'tuning' message will be displayed while a beacon signal is being tuned.
- Once the beacon signal has been tuned, the status message will display a 'receiving' message.
- If a beacon signal is tuned and no corrections are being received, a 'no data' message will be displayed.
- If a beacon signal cannot be tuned, a 'no status' message will be displayed.

The GPS 45 will also display alert messages concerning DGPS operation through the message page. Three DGPS messages may appear:

No DGPS Position indicates that not enough data is available to compute DGPS position.

No RTCM Input indicates that the beacon receiver is not properly connected or the baud rates do not match.

RTCM Input Failed indicates that DGPS data was being received but has been lost.

```

I/O SETUP
-----
RTCM/NMEA
NMEA 0183 2.0
4800 baud
-----
BEACON RECEIVER
FREQ: ____ _KHz
RATE: 25bps
DIST ____ _M
SNR 0dB
No Status
  
```

Beacon Receiver Status

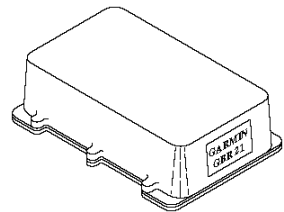

The GARMIN GBR 21 is the recommended beacon receiver for use with the GPS 45.

Other RTCM 104 v. 2.0 receivers are compatible with the GPS 45, but may not provide complete on-screen status or tuning control.

Reference

Simulator Mode

```
OPERATION SETUP
MODE:
[Simulator?]
DATE 18 JAN 94
TIME 06:40:29
OFFSET: -06:00
CONTRAST:
BACKLIGHT TIME:
30 seconds
TONE:MSG Only
```

```
1345 N 015 030
TRACK SPEED
006° 10.0%
POSITION
N 25°05.180'
W077°21.118'
ALTITUDE
425F ± 74F
TIME
10:47:04
```

```
1345 N 015 030
TRACK SPEED
006° 10.0%
POSITION
N 25°05.180'
W077°21.118'
ALTITUDE
425F ± 74F
TIME
10:47:22
```

The GPS 45's simulator mode lets you practice all aspects of its operation without active satellite acquisition. You can also plan and practice trips, enter new waypoints and routes and save them for use during normal operation.

The simulator mode is activated from the Menu Page, with vessel speed and heading controlled from the Position or Navigation Pages. To activate the simulator mode:

1. From the Menu Page, highlight the 'mode' field and press the **ENTER** key.
2. Use the **▲** or **▼** keys to scroll through and select the simulator mode.
3. Press the **ENTER** key to confirm simulator mode.
4. Press **PAGE** to return to the Menu Page.

Once the simulator mode has been activated, use the Position or Navigation Page to set your speed and track. You may also enter a new position if you desire (only from the Position Page). To enter track, speed and position:

1. Highlight the 'track' field and press the **ENTER** key.
2. Enter a track heading and press **ENTER**.
1. Highlight the 'speed' field and press **ENTER**.
2. Enter a speed and press **ENTER**.
1. Highlight the 'position' field and press **ENTER**.
2. Enter a position and press the **ENTER** key.



The GPS 45 does not track satellites in simulator mode. Although you can create and save waypoints and routes while using the simulator mode, never attempt to use the simulator mode for actual navigation. The GPS 45 will always power up in the last selected satellite mode.

The GPS 45 provides 10 hours of operation in normal mode and up to 20 hours of operation in battery saver mode on 4 AA alkaline batteries. Rechargeable Ni-Cad or lithium batteries may also be used. Note that the battery level indicator is calibrated for alkaline batteries, and Ni-Cad and lithium batteries will only show battery life at partial scale. No other functions will be affected.

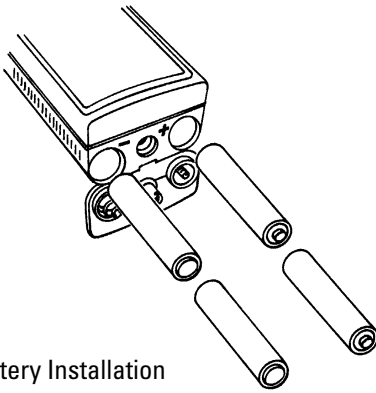

Battery Installation

To install batteries:

1. Remove the battery cover by turning the thumb loop 1/4 turn counter-clockwise.
2. Insert batteries into position. The battery pole you can still see should match the symbol marked on the case
3. Replace the battery cover by turning the thumb loop 1/4 turn clockwise.



Never store your GPS 45 without batteries. A built-in capacitor will save almanac and waypoint data while you are changing the batteries, but will only save data for a period of time (a few hours). If you're storing the unit for the season, put in a fresh set of alkaline batteries to help prevent loss of stored data.

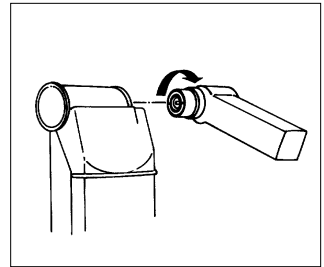

Antenna Installation

The GPS 45's antenna may be removed to attach an optional external marine or automobile antenna.

To remove the antenna:

- Rotate the knurled knob (located at the bottom left of the antenna) toward the front of the unit one-quarter turn.
- Pull the antenna gently away from the unit.
- To install the antenna or an external antenna lead, mate the BNC connector notches with the mounting posts and turn the knurled knob one-quarter turn toward the back of the unit.



Almanac Data—Satellite constellation information (including location and health of satellites) that is transmitted to your receiver from every GPS satellite. Almanac data must be acquired before GPS navigation can begin.

Bearing—The compass direction from your position to a destination.

Course Made Good (CMG)—The bearing from the ‘active from’ position (your starting point) to your present position.

Crosstrack Error (XTE)—The distance you are off a desired course in either direction.

Desired Track (DTK)—The compass course between the ‘from’ and ‘to’ waypoints.

Differential GPS (DGPS)—An extension of the GPS system that uses land-based radio beacons to transmit position corrections to GPS receivers.

Estimated Time of Arrival (ETA)—The time of day of your arrival at a destination.

Estimated Time Enroute (ETE)—The time left to your destination at your present speed.

Grid—A coordinate system that projects the earth on a flat surface, using square zones for position measurements.

Ground Speed—The velocity you are travelling relative to a ground position.

Latitude—A north/south measurement of position perpendicular to the earth’s polar axis.

Longitude—An east/west measurement of position in relation to the Prime Meridian, an imaginary circle that passes through the north and south poles.

Position—An exact, unique location based on a geographic coordinate system.

Track (TRK)—The direction of movement relative to a ground position.

Universal Transverse Mercator- (UTM)— A grid coordinate system that projects global sections onto a flat surface to measure position in specific zones.

Velocity Made Good (VMG)—The speed you are closing in on a destination along a desired course.



The GPS 45 uses a flashing on-screen message to alert you to important information. Whenever the message indicator appears, press the  key to view the message page. There are two types of messages: temporary alerts and condition alerts. Temporary alerts are cleared from the message page after viewing, while condition alerts remain on the message page until the condition has been resolved. Pay careful attention to all messages for your own safety.

Accuracy has been Degraded—The accuracy of the GPS 45 has been degraded beyond 500 meters due to poor satellite geometry or data quality. You should check other navigational sources to verify the position indicated.

Already Exists—The waypoint name you are entering already exists in the GPS 45's memory.

Approaching—You are less than one minute away from reaching a destination waypoint.

Battery Power is Low—The AA batteries are low and should be replaced.

Can't change Active WPT—You have attempted to change the 'active to' or 'active from' waypoint. Clear the active route or GOTO before making your changes.

No DGPS Position—Not enough data is being received to compute a DGPS position.

No RTCM Input—Beacon receiver is not properly connected or baud rates do not match.

Poor GPS Coverage—The GPS 45 cannot acquire the necessary number of satellites to compute a position.

Power Down and Re-init—The GPS 45 is not able to calculate a position due to abnormal satellite conditions. Turn the unit off and verify the last position shown by other means.

Read Only Mem has Failed—The permanent memory has failed and the unit is not operable. Take your unit to an authorized GARMIN dealer for repairs.



Received an Invalid WPT—A waypoint was received during upload transfer that has an invalid identifier.

Receiver has Failed—A failure in receiver hardware has been detected. If this message persists, do not use the unit and take it to an authorized dealer for repair.

Route is Full—You have attempted to add more than 30 waypoints to a route.

Route is not Empty—You have attempted to copy into a route already in use.

Route Waypoint Can't be Deleted—The waypoint you are trying to delete is part of a route. You must first delete the waypoint from the route before striking it from memory.

Route Waypoint was Deleted—A route waypoint entered does not exist in the database and has been deleted from the route.

RTCM Input has Failed—DGPS data being received has been lost. You are no longer receiving the beacon signal.

Searching the Sky—The GPS 45 is in searching the sky for almanac data or the unit is in AutoLocate™ mode.

Stored Data was Lost—All waypoints, routes and almanac data has been lost due to battery failure.

Transfer has been Completed—The receiver is finished uploading or downloading information to the connected device.

WPT Memory is Full—You have used all 250 waypoints in the GPS 45. Delete unwanted waypoints to make room for new entries.



The chart below gives the UTC time offset for the various longitudinal zones. If you are in daylight savings time, add one hour to the offset.

Longitudinal Zone	Offset
W180.0° to W172.5°	-12
W172.5° to W157.5°	-11
W157.5° to W142.5°	-10
W142.5° to W127.5°	-9
W127.5° to W112.5°	-8
W112.5° to W097.5°	-7
W097.5° to W082.5°	-6
W082.5° to W067.5°	-5
W067.5° to W052.5°	-4
W052.5° to W037.5°	-3
W037.5° to W022.5°	-2
W022.5° to W007.5°	-1
W007.5° to E007.5°	0
E007.5° to E022.5°	1
E022.5° to E037.5°	2
E037.5° to E052.5°	3
E052.5° to E067.5°	4
E067.5° to E082.5°	5
E082.5° to E097.5°	6
E097.5° to E112.5°	7
E112.5° to E127.5°	8
E127.5° to E142.5°	9
E142.5° to E157.5°	10
E157.5° to E172.5°	11
E172.5° to E180.0°	12

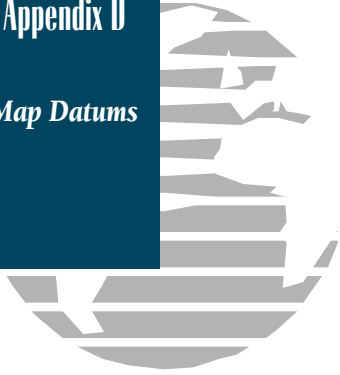

The following list shows the 102 map datums available for the GPS 45. Menu Page abbreviations are listed first, followed by the corresponding map datum name and area.

Adindan	Adindan- Ethiopia, Mali, Senegal, Sudan	Dos 1968	Dos 1968- Gizo Island (New Georgia Islands)
Afgooye	Afgooye- Somalia	Easter Isld 67	Easter Island 1967
AIN EL ABD '70	AIN EL ANBD 1970- Bahrain Island, Saudi Arabia	European 1950	European 1950- Austria, Belgium, Denmark, Finland, France, Germany, Gibraltar, Greece, Italy, Luxembourg, Netherlands, Norway, Portugal, Spain, Sweden, Switzerland
Anna 1 Ast '65	Anna 1 Astro '65- Cocos Isl.		
ARC 1950	ARC 1950- Botswana, Lesotho, Malawi, Swaziland, Zaire, Zambia, Zimbabwe	European 1979	European 1979- Austria, Finland, Netherlands, Norway, Spain, Sweden, Switzerland
ARC 1960	ARC 1960- Kenya, Tanzania		
Ascnsn Isld '58	Ascension Island '58- Ascension Island	Finland Hayfrd	Finland Hayford- Finland
Astro B4 Sorol	Astro B4 Sorol Atoll- Tern Island	Gandajika Base	Gandajika Base- Republic of Maldives
Astro Bcn "E"	Astro Beacon "E"- Iwo Jima	Geod Datm '49	Geodetic Datum '49- New Zealand
Astro Dos 71/4	Astro Dos 71/4- St. Helena	Guam 1963	Guam 1963- Guam Island
Astr Stn '52	Astronomic Stn '52- Marcus Island	Gux 1 Astro	Gux 1 Astro- Guadalcanal Island
Astrln Geod '66	Australian Geod '66- Australia, Tasmania Island	Hjorsey 1955	Hjorsey 1955- Iceland
Astrln Geod '84	Australian Geod '84- Australia, Tasmania Island	Hong Kong '63	Hong Kong '63- Hong Kong
Bellevue (IGN)	Efate and Erromango Islands	Indian Bngldsh	Indian- Bangladesh, India, Nepal
Bermuda 1957	Bermuda 1957- Bermuda Islands	Indian Thailand	Indian- Thailand, Vietnam
Bogata Obsrv	Bogata Obsrvatry- Colombia	Ireland 1965	Ireland 1965- Ireland
Campo Inchspe	Campo Inchauspe- Argentina	ISTS 073 Astro	ISTS 073 ASTRO '69- Diego Garcia
Canton Ast '66	Canton Astro 1966- Phoenix Islands	Johnston Island	Johnston Island Kandawala Kandawala- Sri Lanka
Cape	Cape- South Africa	Kerguelen Isld	Kerguelen Island
Cape Canavrl	Cape Canaveral- Florida, Bahama Islands	Kertau 1948	Kertau 1948- West Malaysia, Singapore
Carthage	Carthage- Tunisia	L. C. 5 Astro	Cayman Brac Island
CH-1903	CH 1903- Switzerland	Liberia 1964	Liberia 1964- Liberia
Chatham 1971	Chatham 1971- Chatham Island (New Zealand)	Luzon Mindanao	Luzon- Mindanao Island
Chua Astro	Chua Astro- Paraguay	Luzon Philippine	Luzon- Philippines (excluding Mindanao Island)
Corrego Alegre	Corrego Alegre- Brazil		
Djakarta	Djakarta (Batavia)- Sumatra Island (Indonesia)		

Mahe 1971	Mahe 1971- Mahe Island		
Marco Astro	Marco Astro- Salvage Island		
Massawa	Massawa- Eritrea (Ethiopia)		
Merchich	Merchich- Morocco		
Midway Ast '61	Midway Astro '61- Midway		
Minna	Minna- Nigeria		
NAD27 Alaska	North American 1927- Alaska		
NAD27 Bahamas	North American 1927- Bahamas (excluding San Salvador Island)		
NAD27 Canada	North American 1927- Canada and Newfoundland		
NAD27 Canal Zone	North Am. 1927- Canal Zone		
NAD27 Caribbn	North American 1927- Caribbean (Barbados, Caicos Islands, Cuba, Dom. Rep., Grand Cayman, Jamaica, Leeward and Turks Islands)		
NAD27 Central	North American 1927- Central America (Belize, Costa Rica, El Salvador, Guatemala, Honduras, Nicaragua)		
NAD27 CONUS	North Am. 1927- Mean Value (CONUS)		
NAD27 Cuba	North American 1927- Cuba		
NAD27 Grnland	North American 1927- Greenland (Hayes Peninsula)		
NAD27 Mexico	N. American 1927- Mexico		
NAD27 San Sal	North American 1927- San Salvador Island		
NAD83	North American 1983- Alaska, Canada, Central America, CONUS, Mexico		
Nhrwn Masirah	Nahrwn- Masirah Island (Oman)		
Nhrwn Saudi A	Nahrwn- Saudi Arabia		
Nhrwn United A	Nahrwn- United Arab Emirates		
Naparima BWI	Naparima BWI- Trinidad and Tobago		
Obsrvtorio '66	Observatorio 1966- Corvo and Flores Islands (Azores)		
Old Egyptian	Old Egyptian- Egypt		
Old Hawaiian	Old Hawaiian- Mean Value		
Oman	Oman- Oman		
Ord Srvy GB	Old Survey Grt Britn- England, Isle of Man, Scotland, Shetland Isl., Wales		
Pico De Las Nv	Canary Islands		
Ptcairn Ast '67	Pitcairn Astro '67- Pitcairn Isl.		
Prov S Am '56	Prov So Amrcn '56- Bolivia, Chile, Colombia, Ecuador, Guyana, Peru, Venezuela		
		Prov S Chln '63	Prov So Chilean '63- S. Chile
		Puerto Rico	Puerto Rico & Virgin Islands
		Qatar National	Qatar National- Qatar
		Qornoq	Qornoq- South Greenland
		Reunion	Reunion- Mascarene Island
		Rome 1940	Rome 1940- Sardinia Island
		RT 90	Sweden
		Santo (Dos)	Santo (Dos)- Espirito Santo Island
		Sao Braz	Sao Braz- Sao Miguel, Santa Maria Islands (Azores)
		Sapper Hill '43	Sapper Hill 1943- East Falkland Island
		Schwarzeck	Schwarzeck- Namibia
		Sth Amrcn '69	South American '69- Argentina, Bolivia, Brazil, Chile, Colombia, Ecuador, Guyana, Paraguay, Peru, Venezuela, Trinidad and Tobago
		South Asia	South Asia- Singapore
		SE Base	Southeast Base- Porto Santo and Madeira Islands
		SW Base	Southwest Base- Faial, Graciosa, Pico, Sao Jorge and Terceira Islands (Azores)
		Timbalai 1948	Timbalai 1948- Brunei and E. Malaysia (Sarawak and Sabah)
		Tokyo	Tokyo- Japan, Korea, Okinawa
		Tristan Ast '68	Tristan Astro 1968- Tristan da Cunha
		Viti Levu 1916	Viti Levu 1916- Viti Levu/ Fiji Islands
		Wake-Eniwetok	Wake-Eniwetok- Marshall Isl.
		WGS 72	World Geodetic System 1972
		WGS 84	World Geodetic System 1984
		Zanderij	Zanderij- Surinam

The GPS 45 is constructed of high quality materials and should not require user maintenance. Should your unit ever need repair, please take it to an authorized GARMIN service center. The GPS 45 has no user-serviceable parts. Never attempt any repairs yourself.

To protect your GPS, keep it in its carrying case when not in use, and never allow gasoline or other solvents to come into contact with the case. Clean the case and lens with a soft cloth and a household window cleaner.

PHYSICAL

Case:	Waterproof, dry nitrogen-filled
Size:	6.15"H x 2"W x 1.23"D (15.6 x 5.1 x 1.23 cm)
Weight:	10 ounces (284g) w/ batteries
Temperature Range:	5° to 158°F (-15° to 70°C)

PERFORMANCE

Receiver:	Differential-ready MultiTrac8™
Acquisition Time:	Approx. 20 seconds (warm) Approx. 2 minutes (cold) Approx. 7.5 minutes (AutoLocate™)
Update Rate:	1/second, continuous
Position Accuracy:	5-10 meters (16-33 ft.) with DGPS corrections* 15 meters (49 ft.) RMS**
Velocity Accuracy:	0.1 knot RMS steady state
Dynamics:	Performs to specification to 3g's

POWER

Input:	4 AA batteries or 5-40vDC
Usage:	.75 watts
Battery Life: (w/ alk. batt.)	10 hours (normal mode) Up to 20 hours (battery saver mode)

Specifications subject to change without notice.

* With optional GARMIN GBR 21 Beacon Receiver Input.

** Subject to accuracy degradation to 100m 2DRMS under the US DOD-imposed Selective Availability Program.

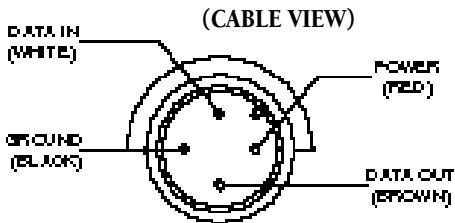

The optional GPS 45 Power/Data Cable allows you to connect to on-board 5-40 volts DC power and connect to external electronic devices.

To connect the power/data cable:

1. Connect the red harness lead to the positive side of a 5-40 volt DC power source.
2. Connect the black harness lead to the negative side of the power source.
3. Connect the white harness lead to the output port of a connected device.
4. Connect the brown harness lead to the input port of a connected device.

The following interface formats are supported by the GPS 45 for driving three NMEA devices:

NMEA 0180

NMEA 0182

NMEA 0183 version 1.5

Approved sentences:

GPBWC, GPGLL, GPRMB, GPRMC, GPXTE, GPVTG, GPWPL

Proprietary sentences:

PGRMM (map datum), PGRMZ (altitude), PSLIB (beacon rec. control)

NMEA 0183 version 2.0

Approved sentences:

GPGGA, GPGLL, GPGSA, GPGSV, GPRMB, GPRMC, GPRTE, GPWPL

Proprietary sentences:

PGRME (estimated error), PGRMM (map datum), PGRMZ (altitude), PSLIB (beacon receiver control)

Complete information concerning NMEA formats and sentences is available from the NMEA at P. O. Box 50040, Mobile, AL 36605; 205-473-1793, 205-473-1669 FAX. Cost of the NMEA materials is \$35 U. S. dollars, plus shipping and handling.

DGPS corrections are accepted on RTCM-104 v. 2.0 format. The GARMIN GBR 21 is the recommended beacon receiver for use with the GPS 45. Other receivers with the correct RTCM format may be used, but may not correctly display status or allow tuning control from the GPS 45.

The GPS 45's optional mounting bracket allows fixed installation on any flat surface or bulkhead, and permits easy removal for portable use. The mounting kit can be installed with or without the swivel base.

To install the bracket on a flat surface or on a bulkhead without the swivel base, mount the L-bracket directly to the surface desired with three #8 flathead screws (not included). Once the L-bracket is installed, the viewing angle may be adjusted by loosening the knob at the bottom right of the bracket.

For swivel base installation, mount the swivel base directly to a flat surface with three #8 flathead screws. Install the L-bracket onto the swivel base using the knob provided (see diagram below). The swivel angle may also be adjusted by loosening the knob.

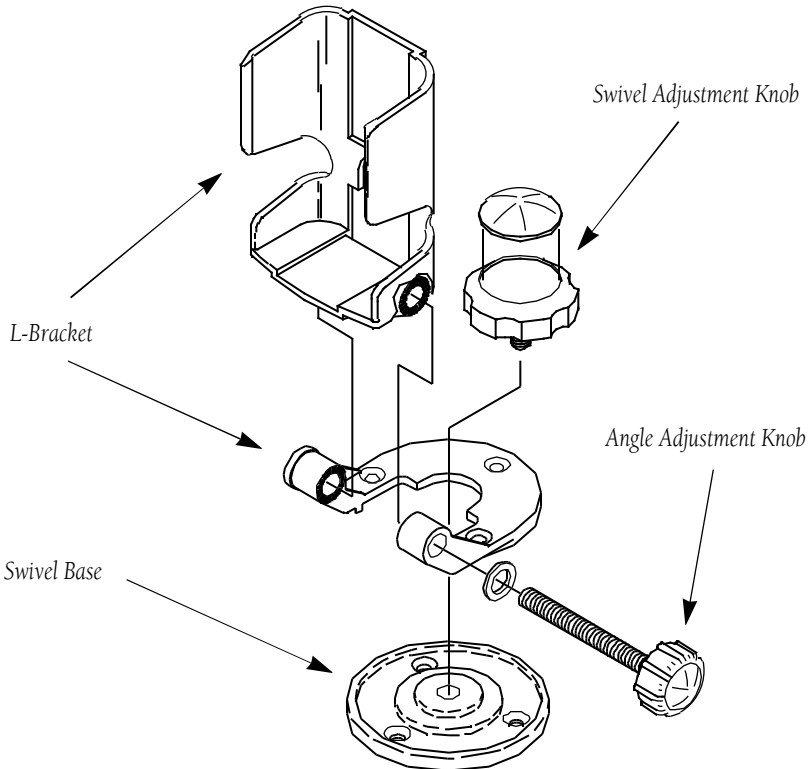

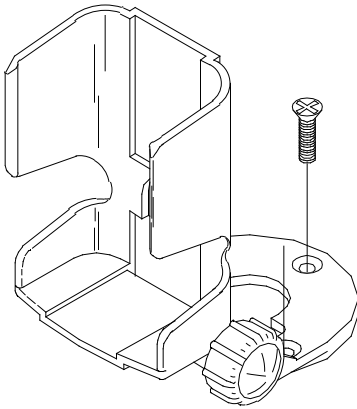

Using the mounting bracket without the swivel base.

The GPS 45 power/data cable can be connected to the mounting bracket for hard-wired fixed-mount use. To attach the power/data cable, slide the cable connector into the mounting slot on the bracket (see below).

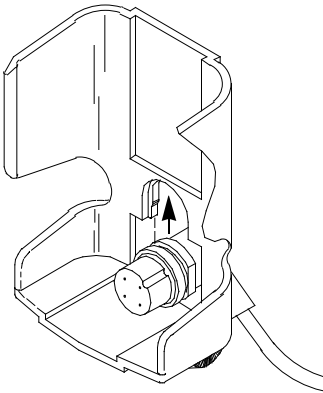

To insert the GPS 45 into the bracket, snap the unit into place from the front of the bracket and press firmly. If you are using the power/data cable, make sure you install the power/data connector in the mounting bracket before inserting the unit in the bracket.

A

Active Waypoints	27
Active Route	28
Active Route Page	30
Altitude Entry	17
Antenna Installation	47
Audio Setup	39
AutoLocate™ Mode	38
Auxiliary Functions	37-46

B

Backlighting On/Off	39
Backlight Timer	39
Battery Installation	47
Battery Saver Mode	38
Beacon Receiver Setup	44-45
Bearing	48

C

Capabilities	iv
CDI Scale Setup	41
Contrast Setting	39
Course Made Good (CMG)	48
Cross Track Error	8-9

D

Definitions	3,48
Desired Track (DTK)	9
DGPS Setup	44-45
Distance and Sun Calculation	37

E

Estimated Time of Arrival (ETA)	31
Estimated Time Enroute (ETE)	9,31

G

Glossary	48
GOTO Function	25
GPS Overview	2
Ground Speed	48

H

Heading Selection	41
-------------------------	----

I

Installation (wiring)	55
Installation (bracket)	56-57
Interface Formats	55
I/O Page	43-45
Interval, track storage	42

K

Keypad Usage	12
Keypad Tone	39

L

Local Time Offset	38,51
Losing Satellite Coverage	15

M

Magnetic Variation	41
Maintenance	54
MOB Function	26
Map Datum List	52-53
Map Datum Selection	40
Map Orientation	42
Map Page	33
Map Functions	34
Map Panning and GOTOs	35
Map Zooming and Scales	36
Menu Page	37
Messages	37
Message Page	37
Message Descriptions	49-50

N

Navigation	3,48
Navigation Page	8,9,25
Navigation Setup	40,41
Navigation Units	41
Nearest Waypoint Page	19
NMEA Selection	43,44
NMEA Output Formats	55
Normal Mode	38



O	
Offset, local time	38,51
Operating Mode Setup.....	37,38
Operation Setup	38,39
Output Setup	43-45
P	
Packing List	v
Page Sequence	10
Page Flowcharts	13-14
Panning	35,36
Position Entry.....	17
Position Page	17
Power Off	11
Power On	4
R	
Range Rings.....	33,43
Reference Waypoints	22
Relative Bearing Pointer	8,9
Resolution, track storing.....	42
Routes	27
Active Route Page.....	31
Creating and Copying	29
Clearing and Activating.....	30
Inverting Routes.....	30
Editing Routes.....	32
On-Route GOTOs.....	32
S	
Satellite Status	15,16
Satellite Status Page	15,16
Searching the Sky	16
Setup Pages	38-45
Simulator Mode.....	46
Sky View Display	5,15
Steering Guidance	8,9,25
Sun and Distance Calculation	37
T	
Time Setup	38,51
Tone Setup	39
Track	48
Track Log Setup	48
Track Recording	42
U	
Units of Measure.....	41
UTC time.....	38,51
UTM Coordinates	40,48
V	
Velocity Made Good (VMG)	48
W	
Waypoints	18
Waypoint Definition Page	21
Waypoint List Page	20
Nearest Waypoint Page	19
Marking Waypoints	18
Creating Waypoints	21
Naming Waypoints	18
Deleting Waypoints.....	24
Editing Waypoints	23
Renaming Waypoints.....	23
Welcome Page	4
Wiring Installation.....	55



© 1994 GARMIN INTERNATIONAL
9875 Widmer Road, Lenexa, KS 66215, USA
Part Number 190-00070-00 Rev. B