

KC5535: KIT - U/SONIC ANTIFOULING BOAT SGL 05/17

Silicon Chip Magazine May 2017 (p74 to p83) and Jun 2017 (p66 to p75)

Rev 1

Batch No: 8W8082

PLEASE READ BEFORE COMMENCING CONSTRUCTION

The guarantee on this kit is limited to the replacement of faulty parts only, as we cannot guarantee the labour content you provide. Our Service Department does not do general service on simple kits and it is recommended that if a kit builder does not have enough knowledge to diagnose faults, that the project should not be started unless assistance can be obtained. Unfortunately, one small faulty solder joint or wiring mistake can take many hours to locate and at normal service rates the service charge could well be more than the total cost of the kit.

If you believe that you may have difficulty in building this kit (which is simply a complete set of separate parts made up to a list provided by the major electronics magazines) and you cannot get assistance from a friend, we suggest you return the kit to us IN ITS ORIGINAL CONDITION for a refund under our satisfaction guarantee.

Unfortunately, kits cannot be replaced under our satisfaction guarantee once construction has been commenced.

CONTACTS:

For queries with regards to the design aspects of this project please contact the Project Designer.

It is recommended to check the designers/publishers website for further updates since this document was issued.

Silicon Chip Publications, POBox 139, Collaroy Beach, NSW 2097, Tel: +61-2-99393295, Fax: +61-2-99392648

www.siliconchip.com.au, silchip@siliconchip.com.au

For **quality issues** please contact the **Production Manager** at Jaycar Electronics and provide the following information:

- Product Number
- Batch No
- Details of Quality Issue

Notes and Errata (at time of print):

Jaycar Electronics:

- *uses netlists to confirm that the PCB artwork matches the schematic(s) and parts list(s) published. Observed variations are verified and incorporated into the kit but may not be published by Silicon Chip.*
- *upgrades the original PCB design to use component footprints, possible component shape, value and lead configuration alternatives and aligned polarized components where possible. You may wish to bend component leads and use component pads further apart.*
- *has updated the project article with relevant notes and errata. It will therefore differ from the original article published in the magazine.*
- *recommends to check the designers/publishers website for further notes and errata since this document was issued, before starting construction.*

Possible Substitutions	Original Part Desc	Subst Part	Subst. Part Desc.
N/A			

PARTS LIST

Please note that catalogue numbers refer to suitable products from the Jaycar product range. Quantities listed refer to the actual number of items required. When purchasing items separately, take pack quantities into account.
 * See section about Substitution * See section about Notes & Errata * Processed Panel not part of Case listed
 Catalogue numbers starting with "E" or listed as "Special Order" (incl. processed panels) are Kit specific and may not be readily available.

For queries with regards to the design aspects of this project please contact the Project Designer at Silicon Chip (tel: +61-2-99339295 or email: silchip@siliconchip.com.au).

CONTROL PCB

Cat.#	Qty*	Description	Component Ident And/Or Location
HP1250	4	PIN PCB 0.9MM GLD	
ER9448	1	RES 0.25W CARB 220K 1.6KV 5%	Red Red Yellow Yellow
RR0524	2	RES 0.5W MTL 10R 1%	Brown Black Black Gold Brown
RR0532	1	RES 0.5W MTL 22R 1%	Red Red Black Gold Brown
RR0584	3	RES 0.5W MTL 470R 1%	Yellow Purple Black Black Brown
RR0572	1	RES 0.5W MTL 1K0 1%	Brown Black Black Brown Brown
RR0588	1	RES 0.5W MTL 4K7 1%	Yellow Purple Black Brown Brown
RR0596	3	RES 0.5W MTL 10K 1%	Brown Black Black Red Brown
RR0598	1	RES 0.5W MTL 12K 1%	Brown Red Black Red Brown
RR0603	1	RES 0.5W MTL 20K 1%	Red Black Black Red Brown
RR0612	2	RES 0.5W MTL 47K 1%	Yellow Purple Black Red Brown
RR0620	1	RES 0.5W MTL 100K 1%	Brown Black Black Orange Brown
RR0623	3	RES 0.5W MTL 130K 1%	Brown Orange Black Orange Brown
RT4648	2	TRIMPOT 25TURN 5K TOP ADJ	5K / 502

CAPACITOR(S)

Cat.#	Qty*	Description	Component Ident And/Or Location
ER9449	1	CAP CER F 1N 2KV 5% P=5MM	Component Ident And/Or Location 1n / 1000p / 102
RC5316	2	CAP CER NPO 22P 50V 5% P=5MM	22pF
RE6086	2	CAP ELECT RB 10U 16V 105C P=2MM 5X11MM	10uF / 16V
RE6194	1	CAP ELECT RB 470U 16V 105C P=3.5MM 8X12	470uF / 16V
RE6330	1	CAP ELECT 2200U 25V 105C L/ESR 16X25	2200uF / 25V L/ESR
RM7010	1	CAP MKT 1N 100V P=5MM 7.5X2.5X6.5MM	1.0n / 1n0 / 102
RM7125	5	CAP MKT 100N 100V P=5MM 7.5X2.5X6.5MM	0.1uF / u1 / 100n / 104

SEMICONDUCTOR(S)

Cat.#	Qty*	Description	Component Ident And/Or Location
EZ9411	3	MOSFET HUF76423P3 60V 33A N-CH TO220	Component Ident And/Or Location HUF76423P3 / Peray 74623P Q1, Q2, Q5
EZ9443	1	IC PROG (KC5535) PIC 16F88-I/P DIP18	EZ9443/KC5535 IC1
PI6503	1	SKT IC TIN/G 18PIN/300MIL	for IC1
RQ5299	1	CRYSTAL 20MHZ HC49U	20MHZ X1
ZD0154	2	LED 5MM CLR RED 3800MCD	LED2, LED3
ZD0172	1	LED 5MM CLR GRN 7500MCD	LED1
ZR1004	1	DIODE 1N4004 400V 1A DO41	1N4004 D7
ZR1020	3	DIODE 1N5819 SCHOTTKY 40V 1A DO41	IN5819 / SOD 81 D1, D2
ZR1038	1	DIODE UF4007 1000V 1A U/FAST DO41	UF4007 D7
ZR1141	2	DIODE BAT46/BAT48 SCHOTTKY DO35G	OA91/BAT46/BAT48 D8, D9
ZR1403	2	DIODE ZENER 1N4733 5.1V 1W DO41	1N4733 (5V1) ZD1, ZD2
ZV1645	1	VREG LP2950ACZ-5.0 5V TO92 MICROPOWER	LP2950ACZ-5.0 REG1

HARDWARE / WIRE(S) / MISCELLANEOUS

Cat.#	Qty*	Description	Component Ident And/Or Location
ES9441	1	FUSE HOLDER PCB ATO/ATC 30A BLADE AUTO	F1
HM3130	2	TERMINAL PCB SCREW 2WAY P=5.08MM ORG	CON3
HM3132	1	TERMINAL PCB SCREW 3WAY P=5.08MM ORG	CON1
HP0149	2	WASHER NYLON M3 FLAT WHT	Spacer for Crystal
HP0400	4	SCREW M3X6MM PHIL R/H/D ZP	Mount PCB
HP0403	3	SCREW M3X10MM PHIL R/H/D SP	Mount MOSFET
HP0425	3	NUT M3 SP	Mount MOSFET
HP0433	3	WASHER MTL M3 S/PRF INT/T SLV	Mount MOSFET
HP0724	1	CABLE GLAND 4-8MM IP68	
HP1200	1	CABLE TIE 100X2.5MM BLK	
LF1278	1	FERRITE CHOKE PREWOUND 470UH 5A	Secure Choke
NS3015	1m	SOLDER 60/40 1MM	
PP0542	1	PLG PNL IP67 LTW 2PIN 5A	
SF2128	1	FUSE BLADE 3A PINK	F1
SL2895	1	GLOBE NEON NE2 BLU 90V PIGTAIL	NEON1
SP0758	1	SWITCH PUSH LCH SPST BLK IP65 14V 10A	S1
WH3040	40cm	CABLE HU RND 24X0.2MM H/D RED	For switch and Transducer Colour may vary
WH5551	10cm	HEATSHRINK 2.5MM X 1.2M CLR	For high voltage parts and transducer socket
WH5554	6cm	HEATSHRINK 6MM X 1.2M CLR	For neon globe & switch terminals

HARDWARE / WIRE(S) / MISCELLANEOUS - LOOSE

Cat.#	Qty*	Description	Component Ident And/Or Location
EC8410	1	PCB (KC5535) PTH SM NTN 159X111	Component Ident And/Or Location double sided plated through hole
EH1937	1	NUT HANSEN LARGE BACK BLACK 50MM PLASTIC	
EH6084	1	LABEL (KC5535) FACEDOWN BLK TXT 123X91	
EM2791	1	T/F (KC5498/KC5499) ETD29 3C85 BIFILAR	
HB6248	1	ENCL POLY/CARB 171X121X55MM CLR	
NA1518	1	GLUE EPOXY J-B WELD JB8270 2X28G TUBE	
YS5605	1	SPARE TRANSDUCER [YS5600/5602] COMPLETE	

OPTIONAL PARTS FOR 2nd CHANNEL (NOT INCLUDED)

OPTIONAL ADD-ON

Cat.#	Qty*	Description	Component Ident And/Or Location
KC5536	1	KIT - U/SONIC ANTIFOUL BOAT 2ND CH 05/17	Component Ident And/Or Location

Improved circuit drives one or two transducers

ULTRASONIC ANTI-FOULING



If you have a boat and keep it in a berth or on a mooring in salt or fresh water, it will be inevitably plagued with marine growth on the hull. Left unchecked, this slows down the boat considerably and leads to a huge increase in fuel consumption. It's the same story for a yacht; marine growth slows it down and makes it less manoeuvrable. So your boat has to be hauled out of the water at least once a year so the hull can be water-blasted and coated in fresh anti-fouling paint. Unless, that is, you have ultrasonic anti-fouling fitted – it keeps the barnacles at bay much longer!

Anti-fouling paint is the tried-and-tested method for preventing marine growth on the hulls of boats but it only works if you use the boat on a regular basis. Anti-fouling paint works by ablation. As the boat moves through the water (the faster, the better) the surface of the anti-fouling paint is worn away to expose fresh coating, which then continues to do its job of inhibiting marine growth.

So anti-fouling is a sacrificial coating – it is meant to be worn away.

If you don't use your boat regularly, the anti-fouling quickly becomes ineffective and marine growth can become rampant. So what's the answer?

Ultrasonic anti-fouling! This may not entirely replace the need for anti-fouling paint but it can greatly increase the interval at which the boat must be pulled out of the water to have this essential maintenance.

Furthermore, the closer you live to the equator (ie, warmer water), the more cost-effective ultrasonic anti-

fouling becomes. On the Queensland or northern New South Wales coast, you will need to have anti-fouling done far more frequently than if you live in the colder climes of Victoria and Tasmania.

The worst situation for marine growth involves boats moored in canal developments, such as on the Gold and Sunshine Coasts, where the water is warm and has poor tidal flow.

What sort of marine growth are we talking about? Everything from algal slime to marine plants and shellfish of all types . . . and coral. Coral on boat hulls? Isn't coral a threatened marine life-form? Certainly not on seldom-used boats moored in relatively warm water!

Salt or fresh water

We originally envisaged that this project would be for boats which remained in salt water. While this is certainly true, one thing we hadn't counted on was that boats which are permanently in fresh water also suffer from the problem.

FOR BOATS

By Leo Simpson & John Clarke

Features

- Suitable for boats up to 14m (up to 8m with one transducer).
- Ideal for boats with single-skin glass-reinforced plastic (GRP) or fibreglass, steel or aluminium hulls.
- Powered by the boat's 12V battery.
- Adjustable low-battery shut-down.
- Very low current drain during shut-down.
- Soft-start feature reduces surge current.
- LED indicators for power, low battery or fault.
- Neon indicators for ultrasonic drive operation.

Maybe it isn't quite as bad as salt but Jaycar Electronics have told us that they sold significant numbers of the original Ultrasonic Anti-fouling kit, and their built-up version, apparently with great success to boat owners who kept their craft on the freshwater lakes of Canada.

So there goes our theory of warm, salt water! OK, we know that it's still true but Jaycar's experience is that Ultrasonic Anti-fouling also works in cold, fresh water.

You'll still need to clean her bottom!

We must emphasise that fitting an ultrasonic anti-fouling system to your boat will *not* eliminate the need to pull the boat out of water from time to time to clean it, but also to inspect and replace sacrificial anodes and to generally inspect the hull and running gear for any damage.

Nor can ultrasonic anti-fouling provide complete inhibition of growth on propellers, rudders, trim tabs and in bow and stern thrusters.

But compared with conventional anti-fouling measures, ultrasonic anti-fouling is far more effective on boats that are used infrequently. And Ultrasonic Anti-fouling has a very big advantage in that it does not pollute waterways.

This new version of our popular ultrasonic anti-fouling system has an improved circuit which drives one or two ultrasonic transducers which are mounted inside the hull of the boat.

It is suitable for boat hulls made of single-skin glass-



Excessive fouling after a boat had been in the water for two years with minimal usage. There was no Ultrasonic Anti-Fouling fitted. This amount of growth would severely impact speed, handling and fuel use.

reinforced plastic (GRP or fibreglass), aluminium or steel/stainless steel. These materials provide good transmission of ultrasonic vibration throughout the hull.

It vibrates the hull at frequencies around 20-40kHz, which makes marine creatures less likely to adhere to the hull. This is explained in more detail below.

Ultrasonic anti-fouling does not work well on boats with timber hulls due to their poor transmission of ultrasonic vibration. Similarly, hulls that use a composite sandwich construction comprising a foam core with an outer skin (usually a styrene core and fibreglass skin) are generally not suitable. That's because the foam core dampens the ultrasonic wave propagation throughout the hull.

How ultrasonic anti-fouling works

Ultrasonic vibration of the hull disrupts the cell structure of algae and this reduces algal growth on the hull. And because there is less algae on the hull, larger marine organisms have a lesser incentive to attach themselves to it.

The principles of ultrasonic anti-fouling have been known for a long time. The effect was discovered a century ago by French scientist Paul Langevin, who was developing sonar for submarines. He found that ultrasonic energy from his sonar tests killed algae. Since he was working with high power transducers, it was assumed that cavitation was causing algal death.

In recent times, though, it has been found that high ul-



Same boat, eighteen months after cleaning AND having the original SILICON CHIP ultrasonic anti-fouling unit fitted. This illustrates that boats still need to be taken out of the water periodically but it's a whole lot better than the shot at left!

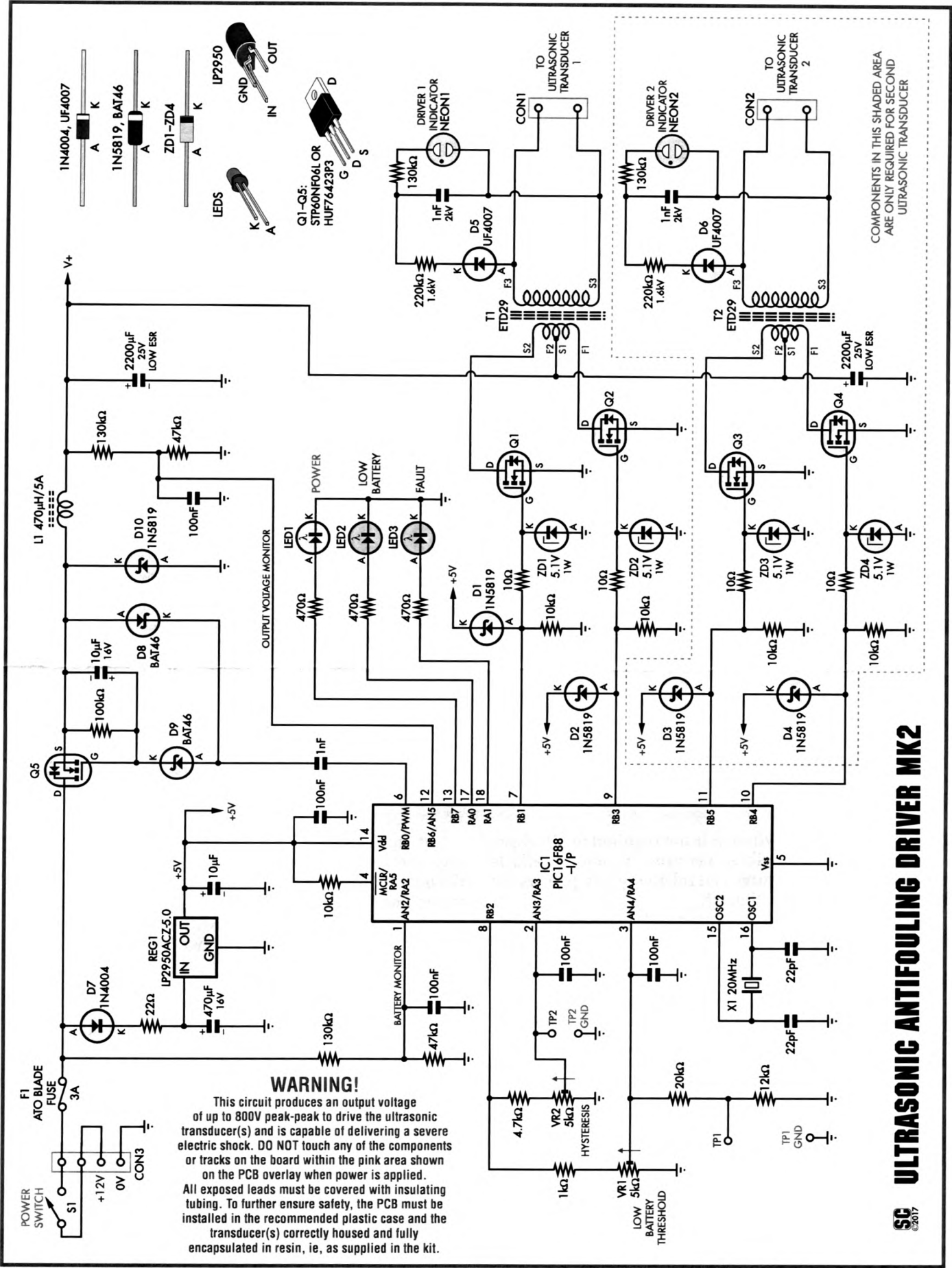

WARNING!
 This circuit produces an output voltage of up to 800V peak-peak to drive the ultrasonic transducer(s) and is capable of delivering a severe electric shock. DO NOT touch any of the components or tracks on the board within the pink area shown on the PCB overlay when power is applied. All exposed leads must be covered with insulating tubing. To further ensure safety, the PCB must be installed in the recommended plastic case and the transducer(s) correctly housed and fully encapsulated in resin, ie, as supplied in the kit.

COMPONENTS IN THIS SHADED AREA ARE ONLY REQUIRED FOR SECOND ULTRASONIC TRANSDUCER

SC ©2017 **ULTRASONIC ANTIFOULING DRIVER MK2**

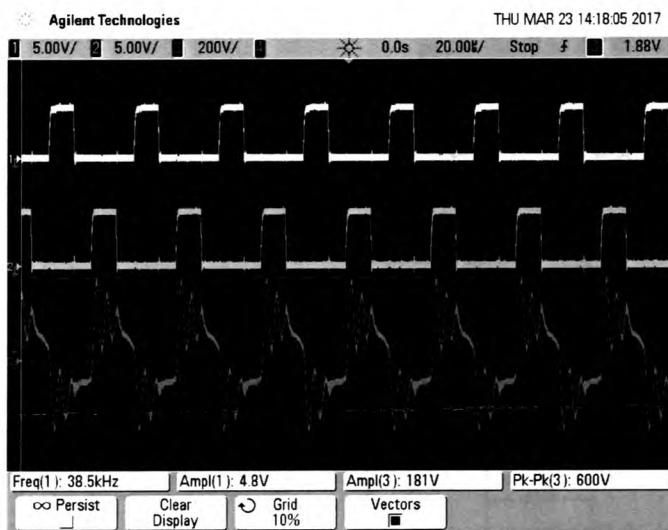
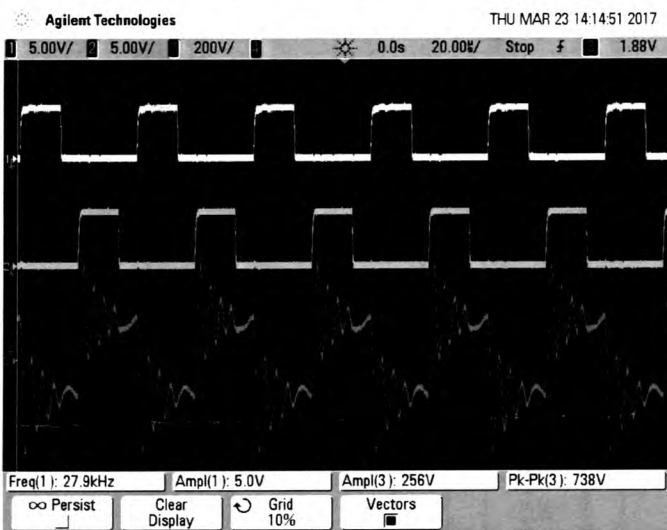
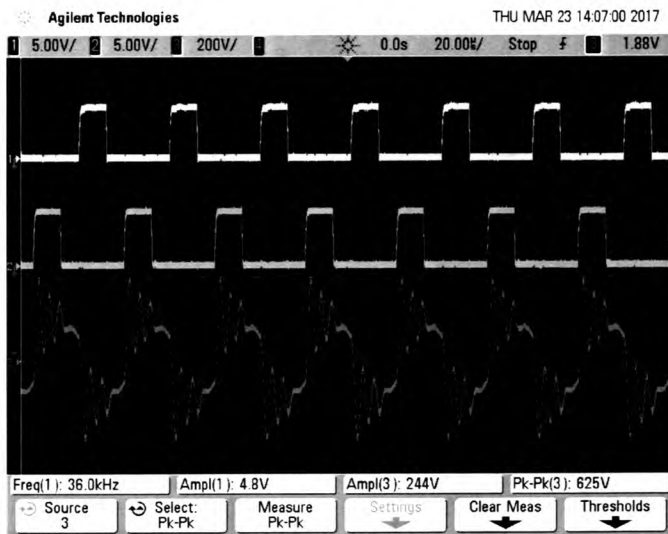
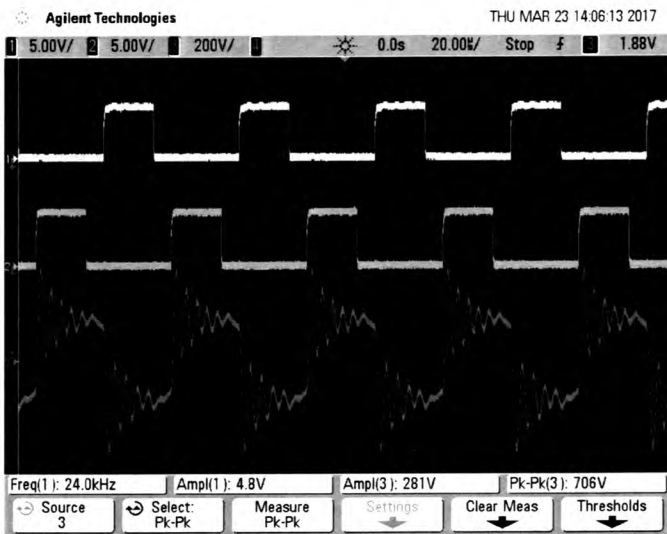

Fig.2; the yellow and green waveforms in each of these four scope grabs show the alternating gate signals to Mosfets Q1 & Q2, while the lower (blue) trace shows the the resulting high voltage waveform from the secondary of the transformer T1. This waveform is applied to the piezoelectric ultrasonic transducer.

trasonic power and cavitation is not required to kill algae.

Instead, ultrasonic vibrations cause resonance effects within algal cell structures and relatively low powers are still enough to cause cell death.

So if the boat's hull can be vibrated over a range of ultrasonic frequencies, algae will not be able to attach to it and so other more menacing marine growth will similarly be discouraged.

Our first Ultrasonic Anti-fouling project for boats was published in the September & November 2010 issues and this has proved to be very popular with boat owners. We have also had lots of good feedback from boat users not only in Australia and New Zealand but from all over the world.

Its popularity is partly due to the fact that the build-it-yourself kit, exclusive to Jaycar stores, is much cheaper than any commercial unit and has proved to be effective in minimising marine growth.

Fig.1 (facing): the PIC16F88 microprocessor provides alternating gate signals to Mosfet pairs Q1, Q2 & Q3,4. Each pair of Mosfets drives a step-up transformer (T1 & T2) and these drive separate ultrasonic transducers. The micro also monitors the battery voltage and shuts down operation if the battery drops below a threshold set by trimpot VR1. Neon indicators show the presence of high voltage at the secondary windings of the two transformers.

But feedback from boat owners has also indicated that improvements could be made to our original design and the first of these is the ability to use it on larger boats. Our recommendation for our first design was that it was suitable for boats up to 10 metres, with larger boats up to 14 metres or catamarans requiring two transducers and two drive units.

Our experience is that one transducer is not quite enough for a 10-metre power boat. Used on a 10-metre fly-bridge cruiser with twin shaft drive, the prototype has performed well in inhibiting marine growth and considerably increasing the intervals at which the boat must be pulled out of the water for service. But a 2-transducer unit would do a much better job.

So our MkII version can drive one or two ultrasonic transducers. With two transducers, it is ideal for larger boats and catamarans, up to about 14 metres.

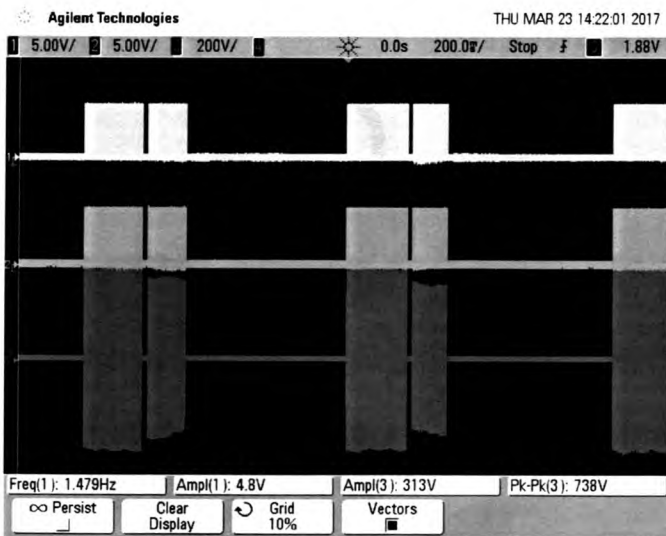

Fig.3: taken at a low sweep speed of 200ms/div, this scope grab shows that the transducer is driven in two frequency blocks, as described in the text.

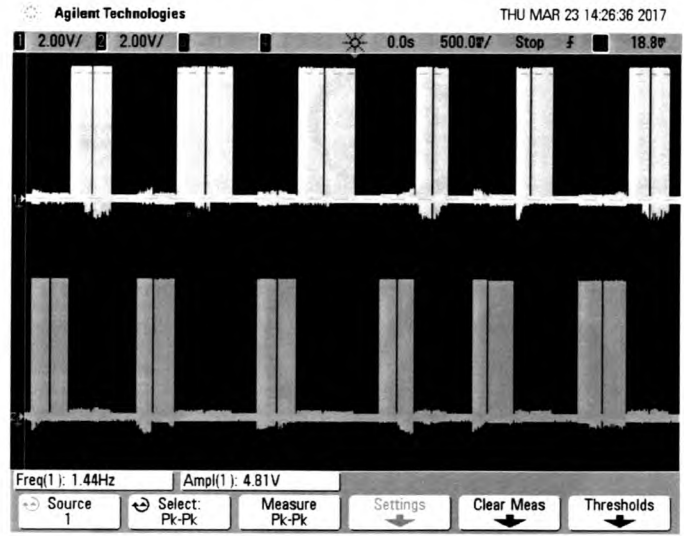

Fig.4: taken at an even lower sweep speed of 500ms/div, this shows the gate drive for Mosfets Q1 & Q4, in the separate channels, and this demonstrates how each transducer is alternately driven with its bursts of frequencies.

The single transducer version would be suitable for boats up to eight metres or perhaps a little larger.

This latest version is also much easier to build, with the Jaycar kit utilising pre-wound transformers and already-potted ultrasonic transducers.

Jaycar has funded the development of both the original and latest version of this project and so the kit is exclusive to that company.

Other changes made to the MkII version include LEDs for power, low battery and fault indication while each ultrasonic driver output has a neon indicator which shows when a transducer is being actively driven.

As well, the low-battery shut-down voltage is now adjustable.

We have also reduced current consumption during low-battery shut-down from 6.7mA down to 170µA. That's a worthwhile saving and this low current drain prevents any further significant discharge of the battery after low-battery voltage shut-down.

The circuit also includes a soft-start feature, where the high-value supply decoupling capacitors are charged slowly when power is first applied. This prevents a high surge current that could cause the fuse to blow.

Lights, (ultra)sound, action

Our new Ultrasonic Anti-fouling project provides far more visual indication that something is happening while it is operating. When power is first applied, the green LED comes on and stays on for 30 seconds which is the initial power on delay and soft-start feature. Then it flashes very brightly, in unison with the alternating flashing of the two neon indicators which show that high voltage is being delivered to the ultrasonic transducers.

If the micro shuts down operation because of low battery voltage, the red low battery LED will flash very briefly at full brightness – helping to conserve the low battery. And of course there is the fault LED which comes on (when there is fault!).

Specifications

- **Operating supply voltage: 11-16V DC**
- **Average current drain: typically 320mA for one transducer, 640mA for two transducers**
- **Peak current: 2A**
- **Output frequency range: 19.08kHz to 41.66kHz in 14 bands**
- **Frequency steps: 12 steps in each band; 80Hz steps at 20kHz increasing to 344Hz steps at 40kHz**
- **Signal burst period: 1000 cycle bursts, ~600ms at 20kHz and ~300ms at 40kHz**
- **Burst interval period: between 300ms and 600ms**
- **Dual transducer drive: alternate**
- **Transducer drive voltage: 250VAC (about 700V peak-to-peak)**
- **Low-battery cut-out threshold: adjustable from 0-15V**
- **Low-battery cut-in threshold: 0-2.5V above cut-out threshold**
- **Low-battery shut-down quiescent current: 170µA**
- **Power-up delay: 30 seconds**

The component parts of our new Ultrasonic Anti-Fouling project: centre is the driver, as described in the text. Plugging into this are one or two ultrasonic transducers, which are attached to the boat hull. The Jaycar kits have these transducers already potted, as shown here.



You can also listen to the unit operating with an AM radio. If you bring the radio near the driver unit or the transducers, you will hear it tweeting and buzzing away, giving you a clear indication that something is happening. And if you have very keen ears and very quiet surrounds (no water lapping on the hull) you might hear faint clicks from the ultrasonic transducers, in concert with the neon indicators.

Operating principle

Our Ultrasonic Anti-fouling system works in a similar manner to commercial systems – at a fraction of the cost. It uses high-power piezoelectric transducers which are attached inside the hull, driven with bursts of ultrasonic signal ranging between about 20kHz and 40kHz.

The reason for using a range of frequencies is two-fold. First, so that various resonance modes of the hull are excited and secondly, a range of frequencies is required to kill the various types of algae.

While a high-power transducer is used and we do drive it with very high voltages, the actual power level is not very great. So typical average current consumption from a 12V battery is around 320mA per transducer, with peak currents of around 2A.

The Ultrasonic Anti-fouling system should be run continuously while ever the boat is moored. In fact, there is no reason to turn it off while the boat is in use, unless you have divers underneath – we have had reports that divers can find the ultrasonic energy immediately underneath the hull causes unpleasant sensations in the ears.

You will need to make sure that the boat's 12V battery is always kept charged. This is no problem for boats in berths which have shore power (ie, 230VAC mains). For boats on swing moorings, a solar panel and battery charge controller will be required.

The Ultrasonic Anti-fouling MkII driver is housed in a sealed plastic IP65 case with a transparent lid. There is one cable gland on one side of the case for the power supply and one or two 2-pin IP67-rated sockets for connection of the transducers. The piezoelectric transducers are en-

capsulated in high-pressure plastic plumbing fittings. On the lid, there is an on/off switch, while the LED and neon indicators can be seen through the lid.

The circuitry for the Ultrasonic Anti-fouling MkII is based on a PIC16F88-I/P microcontroller, power Mosfets and step-up transformers. It can be powered from a 12V battery or a 12V DC 3A (or greater) power supply if shore power is available.

Ultrasonic bursts

Each piezoelectric transducer is driven with bursts of high-frequency signal ranging from 19.08kHz through to 41.66kHz. This is done over 14 bands, with each band sweeping over a small frequency range.

The first band is 19.08-20.0kHz and comprises 12 frequencies with approximate 83Hz steps between each frequency. The other bands also contain 12 frequencies but with larger frequency steps. For example, in the middle band of 24.75-26.31kHz, the steps are about 141Hz. For the top band between 37.87-41.66kHz, the steps are 344Hz.

Each band overlaps the following band by a few hundred hertz. This overlap ensures that the whole range of frequencies is covered from 19.08kHz to 41.66kHz. Each burst of signal comprises two separate frequency signals each for 500 cycles. The burst period for the total 1000 cycles depends on the actual frequencies that are being produced and ranges from 300-600ms. Each transducer is driven alternately to reduce peak current draw.

The two frequency bands within each burst are varied in a pseudo-random way so that the entire range of frequencies is covered every 16 seconds. This sequence is repeated after about 64 seconds. Note that there is a concentration of signal about the resonant frequency of the transducer(s), between 35.21kHz and 41.66kHz.

Circuit description

The complete circuit is shown in Fig.1. PIC microcontroller IC1 drives step-up transformer T1 in push-pull mode via N-channel Mosfets Q1 and Q2. If the circuit is built to drive two transducers, IC1 also drives transformer T2 via

With the obvious exception of the transducer/s (which mount on the boat hull) all components mount on one double-sided PCB, as shown here. Full construction details, along with information on mounting on the boat, will be presented next month.

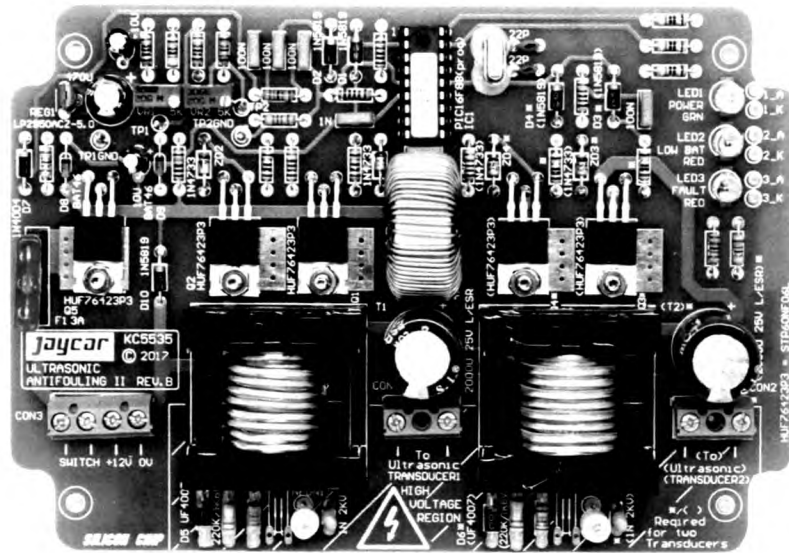

Mosfets Q3 and Q4 in the same manner. The microcontroller runs at 20MHz (using crystal X1) and this allows it to provide the small ultrasonic frequency shifts required.

Mosfets Q1 and Q2 are driven from the RB1 and RB3 outputs of IC1, while Q3 and Q4 (if fitted) are driven from RB5 and RB4. Since these outputs only swing from 0V to 5V, we are using logic-level Mosfets, type STP60NF06L or CSD18534KCS. Their on-resistance (between the drain and source) is typically 10-14mΩ for a gate voltage of 5V. The current rating is 60A/73A continuous at 25°C. There are several other logic level Mosfets that are suitable, including the HUF76423P3.

Mosfets Q1 and Q2 are driven alternately and in turn drive separate halves of transformer T1's primary winding. The centre tap connection is from the battery via the fuse (F1) and soft start Mosfet Q5.

When Q1 is switched on, current flows through its section of the primary winding for less than 50µs, depending on the frequency, after which Q1 is switched off. After 5µs, Q2 is then switched on for less than 50µs. Then, when Q2 switches off, there is another gap of about 5µs before Q1 is switched on again and so on.

Dead-time

The 5µs period during which both Mosfets are off is the "dead time" and it allows one Mosfet to fully switch off before the other is switched on. The alternate switching of the Mosfets generates an AC waveform in the primary

of T1 and this is stepped up in the secondary winding to provide a voltage of about 250VAC, depending on the particular frequency being switched and the piezoelectric transducer impedance at that frequency.

Mosfets Q1 and Q2 are rated at 60V. Should the drain voltage exceed this substantially, they will enter "avalanche breakdown", acting a bit like zener diodes and clamp the voltage to around 80V.

This is safe as long as the shunted current and conduction time are within the device's ratings, which is the case for all recommended Mosfets. This is important since a high-voltage transient is generated each time the Mosfets switch off, due to the transformer's magnetic field collapsing.

Protection for the gates of the Mosfets is provided by 5.1V zener diodes ZD1 & ZD2 (and ZD3/ZD4 for Q3/Q4). This might seem unnecessary since the Mosfets are only driven from a 5V signal but the high transient voltages at the drains can be capacitively coupled to the gate. These 5.1V zener diodes also help prevent damage to the RB1 and RB3 outputs of IC1 due to coupled voltage spikes (RB5/RB4 are similarly protected by ZD3 and ZD4).

Further protection is provided for the outputs of IC1 by schottky diodes D1-D4. These clamp the voltages at these pins to about +5.3V. They are in parallel with the internal protection diodes of IC1.

BLANK

Single and Dual Channel PCB assemblies:

Confirm that the PCB pads for the crystal
 CANNOT contact the crystal case!
 If there is the possibility of a short
 (as shown on the right),
 trim two nylon washers as shown and
 use the washers as spacers between PCB and crystal.

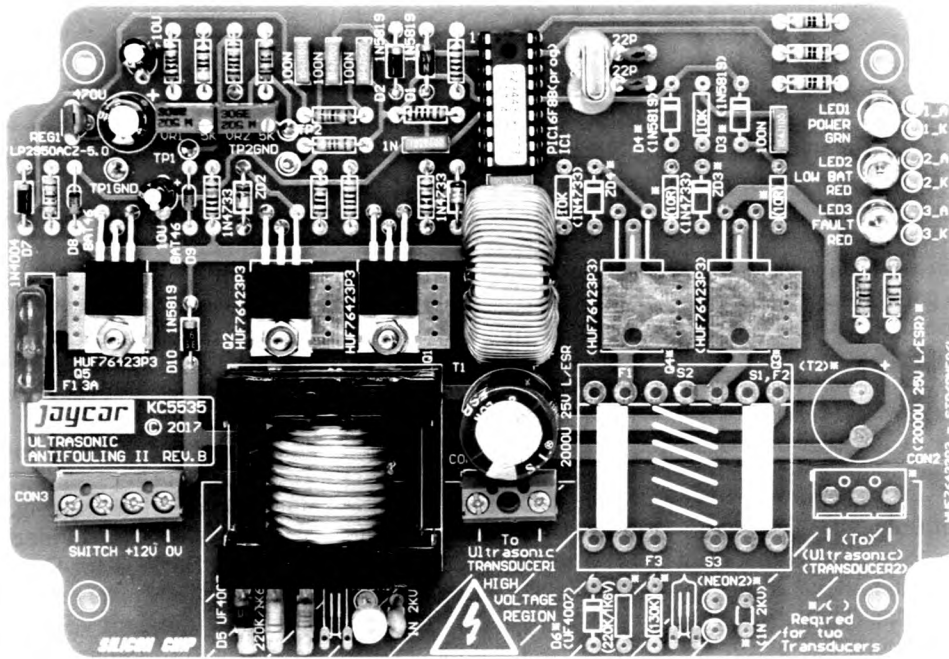
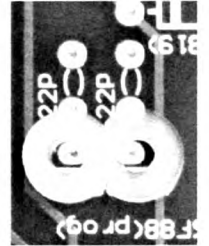
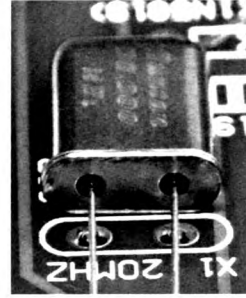

Single Channel
 PCB assembly.

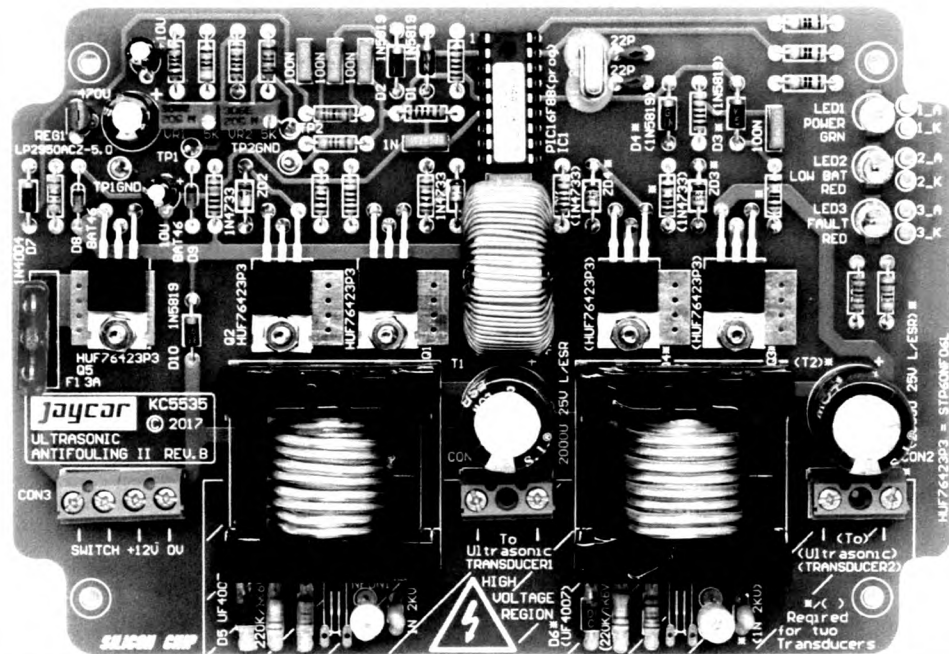

Dual Channel
 PCB assembly.

Note: this
 assembly
 requires both
 the main kit and
 the add-on kit.



(Left): here's the "business end" of the system, the Ultrasonic Transducer, which sets up the vibration pattern in the boat hull which marine vegetation doesn't particularly enjoy! Because these operate at high voltage (~700-800V peak-to-peak) they must be fully enclosed ("potted") in a suitable enclosure, as shown above. (The Jaycar kit will have potted transducers).



Neon relaxation oscillators

The output from transformers T1 and T2 is a high-voltage 250VAC waveform; up to 700V peak-to-peak. We use neon indicators to show whenever the transformer is delivering its voltage. Note that the NE2 neon lamps are not fast enough by themselves for this job. They can flash at a maximum rate of 20kHz, while the transformer output frequency can be above 40kHz.

So the neons are driven via a circuit comprising high voltage fast diode D5 (or D6), a high voltage 220k Ω resistor, a high voltage 1nF capacitor and 130k Ω current-limiting resistor. The diode and 220k Ω resistor charge the 1nF capacitor up over several cycles of ultrasonic signal until the voltage across the capacitor reaches the breakdown voltage of the neon lamp.

The 1nF capacitor can charge because the neon draws very little current until breakover, at around 70V. When this voltage is reached, the neon conducts by a gas discharge between its electrodes and the voltage across it drops to around 50V. The series 130k Ω resistance limits the current, which must be kept under 300 μ A to prevent electrode erosion. Once the 1nF capacitor has discharged, it starts recharging on the next cycle.

Hence, the neon and its associated components form a classic relaxation oscillator.

Battery voltage monitoring

In addition to driving Mosfets Q1-Q4, microcontroller IC1 monitors the battery voltage and if necessary, shuts down the drive signals to prevent the battery from discharging below a set threshold.

This is done to prevent long-term damage to the battery and also to avoid discharging a boat's main battery if it is also used to power automatic bilge pumps or to start the motor. Of course, larger boats will have multiple batteries but the circuit still needs low battery protection.

The incoming 12V supply is monitored via a voltage divider consisting of 130k Ω and 47k Ω resistors and the resulting voltage is filtered with a 100nF capacitor and monitored by IC1 at pin 1, the AN2 analog input. The resistors reduce the battery voltage to a 0-5V range, suitable for feeding to IC1. So for example, if the battery voltage is 11.5V, pin 1 will be at 3.054V. IC1 converts this voltage into a digital value using its internal analog-to-digital converter (ADC) and this is compared against a reference voltage set by trimpot VR1.

Trimpots VR1 and VR2 are fed with 5V from IC1's RB2

output at pin 8 which is held at 5V during normal operation. VR1 connects to pin 8 via a 1k Ω resistor and VR2 connects via a 4.7k Ω resistor, both of which limit their adjustment ranges. RB2 drops to 0V during low battery shut-down, to eliminate the current drawn through VR1 and VR2.

VR1 is used to set the lower voltage threshold, below which the Anti-fouling Unit switches off. VR1 is adjusted so that the voltage at TP1 is 1/10th the desired cut-out voltage. TP1 is connected to VR1's wiper via 20k Ω /12k Ω resistive divider. So say you set the low battery shut-down to 11.5V, by adjusting VR1 until TP1 reads 1.15V.

Given that the division ratio is 0.375 [12k Ω /(20k Ω + 12k Ω)], we can infer that the voltage at the wiper of VR1 (and thus IC1's AN4 analog input) is 3.067V [1.15V \div 0.375], which is very close to the 3.054V quoted above for the voltage at pin 1 with a battery at 11.5V, as you would expect.

The 5V supply rail for IC1 comes from REG1, an LP2950ACZ-5.0 low quiescent current regulator. This has a factory-trimmed output that is typically within 25mV of 5V (ie, 4.975-5.025V). Quiescent current is typically 75 μ A and this is part of the reason that during low battery shut-down, the current drawn by the Ultrasonic Anti-fouling circuitry remains so low.

When low-battery shut-down occurs, LED1 is switched off and the Low Battery indicator, LED2 flashes briefly about once every two seconds. Mosfets Q1-Q5 are all switched off and the 5V supply to VR1 and VR2 from output RB2 goes low, as the microcontroller goes into sleep mode, with the 20MHz oscillator also stopped. An internal watchdog timer then wakes the microcontroller up every two seconds to re-measure the battery voltage and flash LED2.

One problem with this is that as soon as the unit goes into shut-down, the battery voltage is likely to rebound and then the circuit will restart normal operation, the battery voltage drops again, shut-down is reinstated and so on; not ideal.

To prevent this, we have incorporated hysteresis into the shut-down function and this is set with trimpot VR2. It sets the increment of voltage by which the battery voltage must rise above the low battery threshold, for normal operation to be restored. The increment or difference between these two thresholds is known as the hysteresis.

Typically, you might decide that the battery voltage must rise by 1.5V above the low battery threshold, ie, the battery should rise to 13V. To do this, you would set VR2 to 1.5V, measured at test TP2.

So if the unit has shut down and the battery is subsequently charged to 13V, normal operation will resume, with

LED1 flashing in unison with the neon indicators.

Soft start facility

N-channel Mosfet Q5 provides soft starting, whereby the 2200 μ F bulk bypass capacitors are slowly charged at power-up to prevent high surge currents. If the capacitors were directly connected to the 12V supply, a high surge current of many amps is liable to blow the fuse. The high capacitor charging current will also momentarily exceed the current rating of the capacitor.

The gate of Q5 is driven by a switched-capacitor charge pump comprising diode D8 and D9 together with 1nF and 10 μ F capacitors. The 1nF capacitor is connected to the pulse width modulated (PWM) output pin of IC1, pin 6. Initially, this pin is at 0V but shortly after power-up, it is set to produce a 4.88kHz square wave.

Each time pin 6 goes high, the 1nF capacitor couples this voltage to the anode of D9 and thus current flows into the positive end of the 10 μ F capacitor, charging it slightly. Because the 10 μ F capacitor is 10,000 times the value of the 1nF capacitor, the increase in voltage across the 10 μ F capacitor is very small.

When the PWM output is low, at 0V, any voltage across the 1nF capacitor is discharged via schottky diode D8. D8 is connected to the Mosfet source and so voltage developed across the 1nF capacitor is with respect to this source terminal, which is connected to the V+ rail powering transformers T1 and T2.

The 10 μ F capacitor charges to a few volts above the source terminal after about 10,000 cycles, which at 4.88kHz is just over two seconds. It never quite reaches 5V though, in part because of the forward voltages of diodes D8 and D9 but also because the 10 μ F capacitor has a 100k Ω discharge resistor across it. In combination with the capacitor value, this gives a one-second discharge time constant.

So there is a constant battle between the 1nF capacitor trying to charge the 10 μ F capacitor while the 100k Ω resistor is discharging at the same time. With a 4.88kHz PWM frequency, this tug-of-war results in a gate-source voltage of about 1.6V, insufficient for Q5 to reach full conduction.

Higher PWM frequencies give a higher gate voltage, as there are more charge cycles per second to counter the slow discharge of the 10 μ F capacitor. For example, at 19.53kHz we get a 3.2V gate-source voltage.

At this point, the Mosfet should be conducting sufficiently to charge the 2200 μ F capacitors. So the soft start feature is provided by increasing the PWM frequency from pin 6 to increase Q5's conduction over the first few seconds of operation.

Once Q5 is in at least partial conduction, the voltage across the 2200 μ F capacitors can be measured via the 130k Ω and 47k Ω voltage divider resistors at the AN5 analog input of IC1, pin 12.

If there is a short circuit (eg, due to a faulty capacitor or Mosfet), the capacitor voltage will still be near zero. The gate drive can then be switched off and a fault indicated by Fault LED3 flashing.

If there is no short circuit, the PWM is also switched off and pin 6 goes to 0V. The 10 μ F capacitor will start to discharge via its parallel resistor, switching Q5 off. However, there is no current draw as Mosfets Q1-Q4 remain off so the V+ voltage rail should remain at 12V, held up by the 2200 μ F capacitors.

If any of the 2200 μ F capacitors are leaky, the V+ rail will drop. IC1 can detect this by re-measuring the voltage at input AN5 and comparing it to the voltage while Q5 was switched on. If V+ has dropped by more than 2V, there is a problem and so the unit switches off and flashes the Fault LED.

The slow charging of the 2200 μ F capacitors during power-up and the testing described above should prevent the fuse from blowing unless a fault occurs while the unit is running. In that, case the fuse will blow to protect the rest of the circuit.

Once the checks have completed, Q5 is switched on fully by producing a 156kHz square wave at pin 6, giving a gate-source voltage of around 4.6V for Q5, giving a very low on-resistance in order to feed the ultrasonic drive circuitry.

Inductor L1 is included in series with Q5 to reduce high transient current flow through Q5 and the fuse from the 12V supply. Instead, any high current transients are drawn from the 2200 μ F capacitors. It also limits the peak current drawn from the input supply. This helps to prevent any nuisance blowing of the fuse and it also reduces the amount of hash radiated from the supply wiring.

Reverse polarity protection for the circuit is provided by diode D7, which protects regulator REG1, its associated capacitors and microcontroller IC1. However, if the unit is hooked up with reverse supply polarity, current can still flow through the body diodes of Mosfets Q1-Q4, via the primaries of transformers T1 and/or T2, through Q5's body diode and through fuse F1. The fuse will then rapidly blow, isolating the circuit and preventing further damage.

That's it for this month. In our June issue we will give the full assembly, set-up and installation details. **SC**

BLANK

Ultrasonic Anti-Fouling Unit for Boats, MkII

By Leo Simpson & John Clarke

Part 2: building it and fitting it to your boat

If you own a boat which spends its time in the water, you'll know what a (costly!) bane marine growth can be. Last month we introduced our new, improved Ultrasonic Anti-Fouling Unit which can significantly reduce the amount of growth on your hull – and increase the interval between slipping and cleaning.

Ultrasonic anti-fouling won't completely eliminate marine growth but it can minimise it. As we explained last month, the tiny organisms which like to attach to your hull will be actively discouraged from, well, attaching. And the larger marine plants which feed on them will go elsewhere.

That's the theory – and using our previous Ultrasonic Anti-Fouling Unit (Sept, Nov 2010) as a yardstick, the theory is well borne-out in practice. Growth-cleaning intervals can easily be doubled and even then there is less growth into the bargain, as our photos last month showed.

There are only a few hull types which aren't suitable (which we covered last month) and, somewhat surprising to us, ultrasonic anti-fouling is effective in fresh water as well as salt.

We confidently expect this new, higher performance Ultrasonic Anti-Fouling Unit to be even more effective than the previous model and well worth the investment in money and time to build it and fit it to your boat.

Construction

The Ultrasonic Anti-fouling MkII circuitry is built on a double-sided, plated through PCB coded 04104171 and measuring 158.5 x 110.5mm. This is mounted inside an IP56 sealed polycarbonate enclosure with a clear lid, measuring 171 x 121 x 55mm.

Use the PCB overlay diagram, Fig.5, as a guide during construction. You can build the unit to drive one or two transducers. For the single transducer version, CON2, T2, Q3, Q4, ZD3, ZD4, D3, D4, D6 and all associated resistors and the 1nF 2kV capacitor are not required.

All parts for the second transducer are depicted on the

area of the circuit diagram (published last month) shaded yellow. Similarly, the component overlay diagram of Fig.5 is shaded yellow to show the extra parts for the second transducer. So if you are going to build a one-transducer version, ignore any discussion of these particular parts in the construction procedure.

Assembly can begin by installing the resistors and optional PC stakes. Use the resistor colour codes but you should also check each resistor using a digital multimeter (DMM).

Note that the 220kΩ and 130kΩ resistors near the neon lamps are first covered in a 10mm length of 3mm diameter heatshrink tubing before being fitted to the PCB, to reduce the chance of electric shock if you make accidental contact with these leads. Use a hot air gun to shrink the tubing after the resistors have been soldered in place.

PC stakes can then be installed for TP1 & TP2 and the



Unlike the earlier design, which required the ultrasonic transducer to be "potted", the MkII version uses the Soanar YS-5606 (from Jaycar) which comes already potted.

The Ultrasonic Anti-Fouling Unit can be built to drive one or (as shown here) two ultrasonic transducers. If your craft is less than 8m long, you should be able to get away with one – in which case, the majority of components on the bottom right of this photo are not installed (see below).

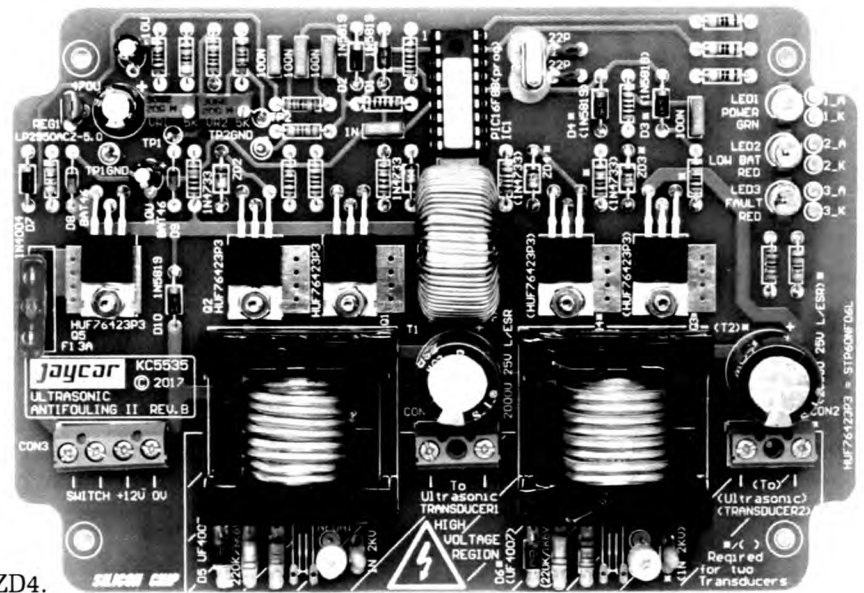

two TP GND points. Following these, mount the diodes, which must be orientated as shown in Fig.5. Note that there are several different diode types: 1N5819s for D1-D4 and D10; UF4007 for D5 and D6; 1N4004 for D7; BAT46 for D8 and D9; and 5.1V zener diodes for ZD1-ZD4.

As with the resistors, diodes D5 and D6 should be covered in 3mm heatshrink tubing before installation.

Next, install the 18-pin socket for IC1, taking care to orient it correctly. Leave IC1 out for the time being. Q1-Q5 can be fitted next. These mount horizontally above the PCB and are secured with a 6-10mm M3 screw, star washer and nut. Bend the leads at right angles so they can be inserted into the allocated holes. Secure the tab of each Mosfet before soldering its leads.

You can then fit regulator REG1, again orientated as

shown in Fig.5. Bend its leads to fit the PCB pads and solder it in place. Then proceed to mount the capacitors. The electrolytic types must be oriented with the polarity shown.

Make sure the 1nF MKT capacitor is placed in the position just above and to the left of ZD1. The remaining MKT capacitors are 100nF. The 1nF 2kV capacitors are installed near T1 and T2.

The screw terminals can go in next. The 3-way terminals

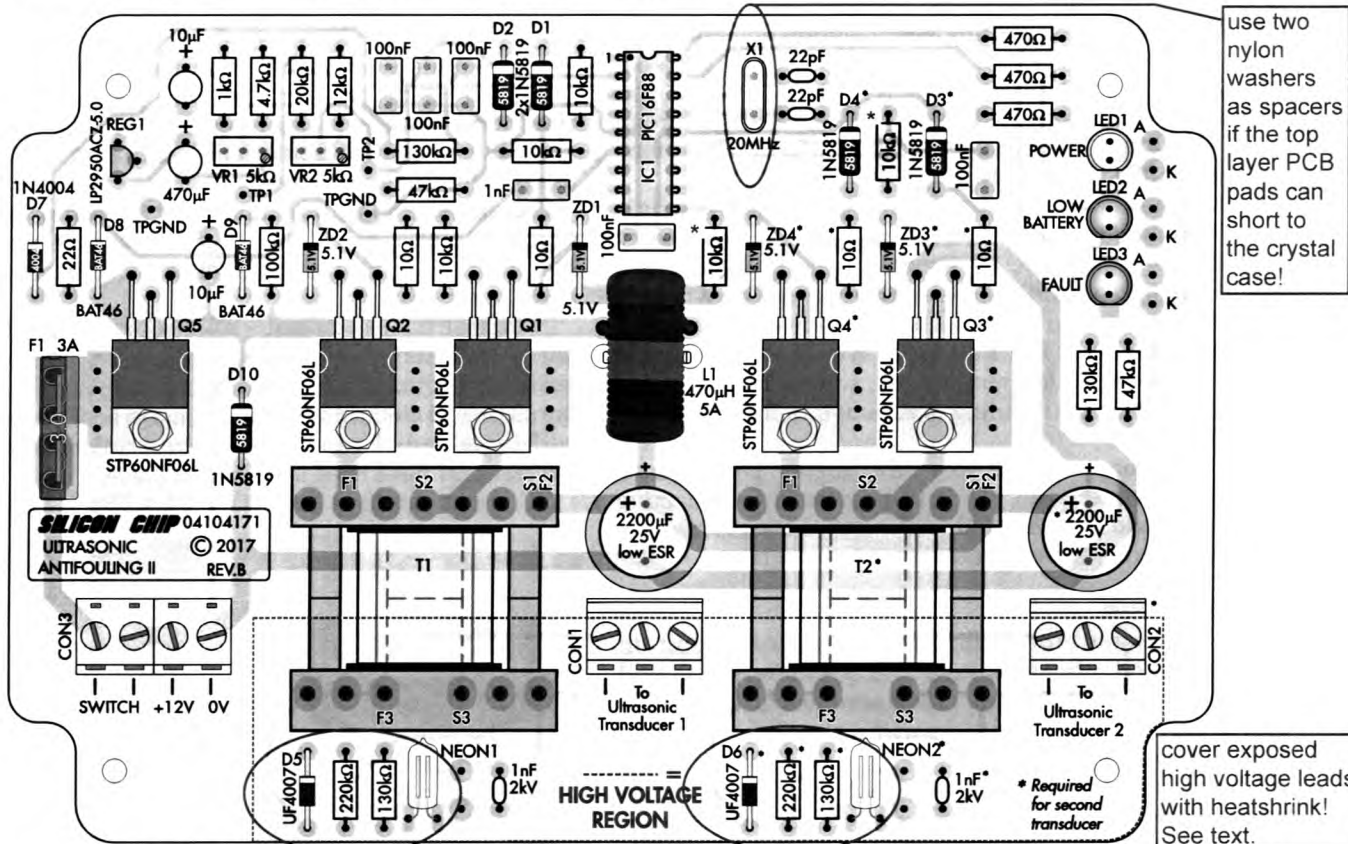
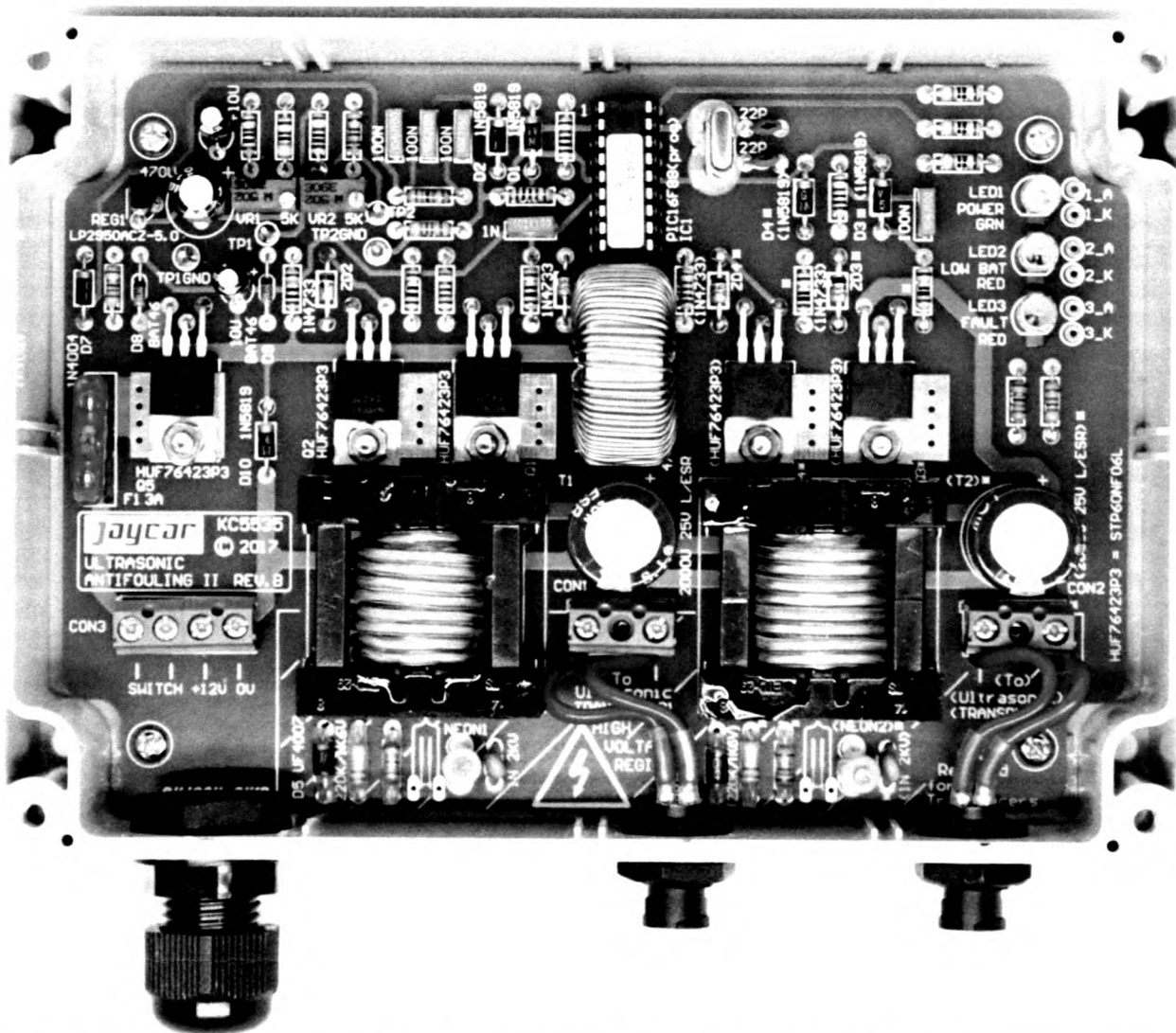

Fig.5: component overlay for the two transducer version of the Ultrasonic Anti-Fouling Unit, MkII. To build the single transducer version, simply leave out all components in the light yellow section of the PCB – Q3, Q4, ZD3, ZD4, D3, D4, D6, NEON2, T2, CON2 and associated resistors/capacitors. Note the area of the PCB with a dashed red border/light pink background has high voltages on both the tracks and component leads when operating.



Here's what the PCB looks like mounted inside the waterproof polycarbonate box with external connections made . . .

for CON1 and CON2 are modified to remove the centre terminal, to increase the voltage rating between the two outer contacts.

Fully unscrew the centre screw and prise it out of the plastic connector. The central contact will slide out of the housing. The screw terminals are installed with the lead

entry toward the lower edge of the PCB.

CON3 is made up of two 2-way screw terminals dovetailed together. Install it with the lead entry also toward the lower edge of the PCB.

Insert the leads of inductor L1 into the PCB and secure it in place with a cable tie that wraps around the lower part

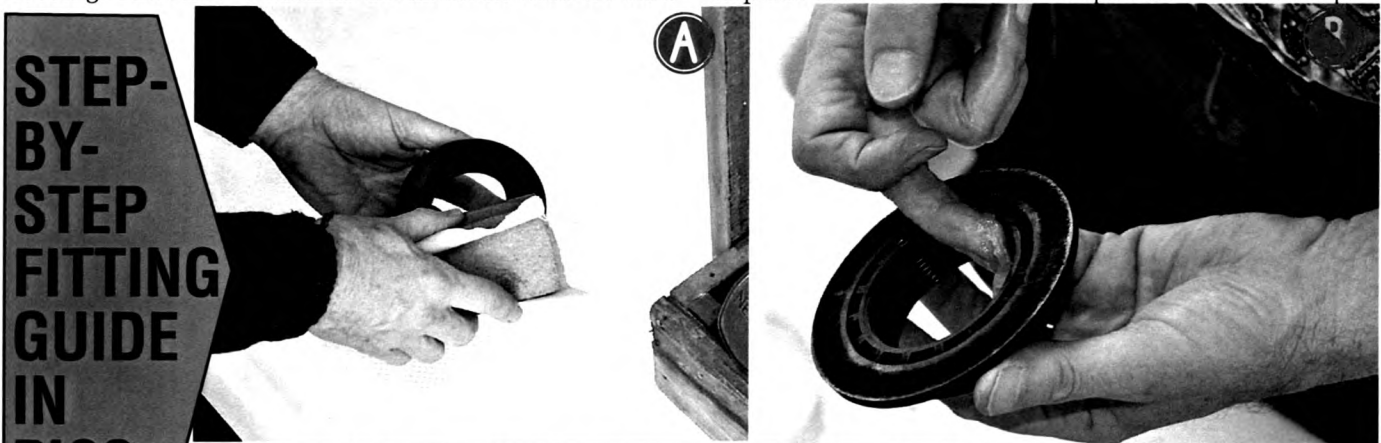

STEP-BY-STEP FITTING GUIDE IN PICS

A: Roughen the bottom of the 50mm flanged nut with some coarse sandpaper. This is to give a good "key" for the adhesive to ensure it won't vibrate loose when fixed to the boat hull.

B: It's important that glue doesn't get into the thread, where it would clog it up. Smear a good coating of Vaseline right around the threads - make sure it doesn't get on the bottom of the flange.

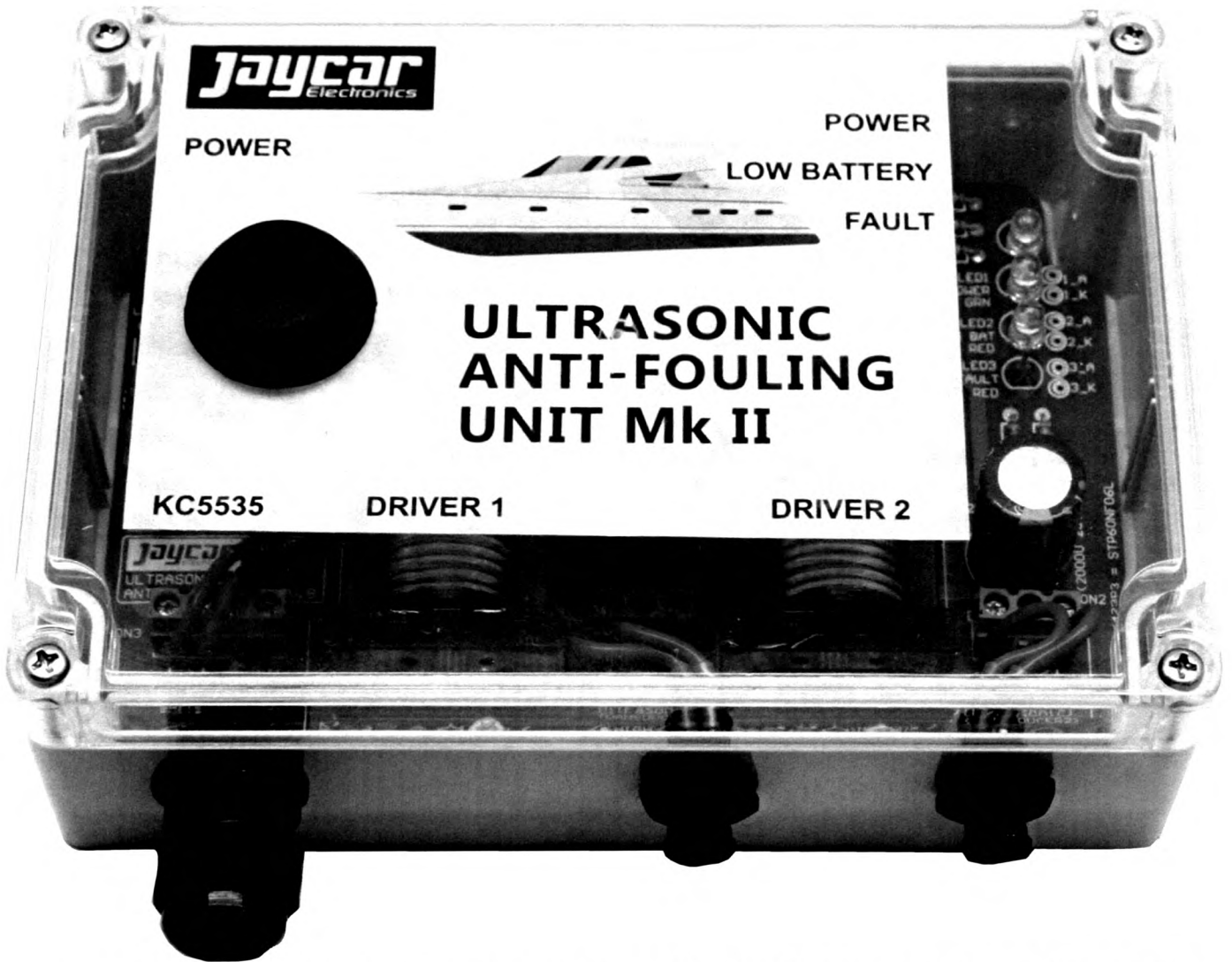

... and here it is with the lid fitted, with the front panel label mounted inside for protection from the marine environment.

of the toroid and through the two holes in the PCB. Once secured, solder the leads in place. The fuseholder for F1 can then be fitted. This requires good solder joints so use a hot soldering iron and pre-heat the fuse holder terminals. When applying solder, make sure it has adhered to both the terminals and the PCB pads.

Crystal X1 can be installed next, followed by trim pots VR1 and VR2. Orient the adjustment screws as shown so that clockwise rotation will give a rising voltage adjustment.

The LEDs are fitted next. The green LED (LED1) is for Power indication and the two red LEDs for Low Battery and Fault indication (LED2 and LED3). The anodes are the



C: Move the empty flange around the hull to determine the best transducer mounting position. When you're happy with your choice, roughen the surface as you did the black flange – for the same reason.



D: We're recommending J-B Weld to secure the flange to the hull. It's not that easy to buy (but Jaycar stores do stock it – Cat NA1518) and it's not real cheap – but it sticks like the proverbial.



You'll need each of these to mount the transducers in your boat: some Vaseline (petroleum jelly), some Fix-a-tap waterproof lubricant (available at plumbing suppliers) and some J-B Weld two-part epoxy (available at Jaycar stores). We do not recommend any other epoxy glues – J-B Weld really holds on even with a boat hull's vibration and stress!

longer of the two leads and these are inserted in the LED holes marked "A" on the PCB.

We positioned our LEDs so the tops were 20mm above the PCB for better visibility. You could place these higher if you wish, up to 40mm above the PCB (assuming the leads are long enough).

Fit the neon indicators after slipping 5mm lengths of 6mm diameter heatshrink tubing over the leads for insulation.

Initial testing

Before installing the transformers, do some tests on the PCB. It is safer to work on the PCB without the transformers installed, since high voltages are not being produced. Initially, adjust VR1 fully counter-clockwise by rotating the adjustment screw. This sets the low battery shut-down at its lowest voltage.

Insert the fuse and place a short length of wire between the switch terminals for CON3. Make sure IC1 is **not** in its socket and connect 12V across the 0V and +12V terminals of CON3.

Check that the voltage between pins 5 and 14 of the IC1 socket is close to 5V (4.975-5.025V). Switch it off, insert IC1, then re-apply power. The power LED should be lit



E: Apply a good layer of mixed glue all over the roughened base of the flange, again making sure you don't get any on the thread. You have quite a while before it starts to cure so take your time!

and voltage across the 2200µF capacitors should rise up to around 12V after a few seconds.

You can adjust VR1 for the required low battery voltage setting. This is done by monitoring the voltage between TP1 and TP GND for 1/10th the required voltage. If you aren't sure, adjust for 1.15V (a cut-out voltage of 11.5V). Then set the hysteresis by adjusting VR2 and monitoring the voltage between TP2 and TP GND. If unsure, set this to 0.5V.

You can check the operation of the low battery cut-out feature now if you have access to an adjustable supply. After power up, wait about 30 seconds until the power LED flashes on and off. This indicates that Mosfets Q1-Q4 are now being driven.

Slowly reduce the supply voltage until the power LED switches off and the low battery LED flashes and note the voltage. Battery voltage readings are averaged over about 10 seconds and so you need to wait this long each time after dropping the supply voltage.

Once low battery shut-down has occurred, assuming it's at the expected supply voltage, increase the supply until the circuit restarts with the power LED lit, as before, waiting 10 seconds between each adjustment. Readjust VR1 and VR2 if needed.

$$V_{bat} > V_{lowbat} + V_{threshold}$$

Note that during low-battery shut-down (and while ever the fault indicator is showing), VR1 and VR2 are powered down and so these cannot be set correctly. You can only successfully set VR1 and VR2 during normal startup, when the power LED is continuously lit, or during normal operation when the power LED is flashing.

Finishing construction

Now switch off power and wait until the power LED goes out. Then wait for the low battery LED to stop flashing. This can take up to 30 seconds. Now check voltage across one of the 2200µF low-ESR capacitors. Only install the transformers when the capacitor voltage has dropped to below 1V.

Note that the primary side of the transformer has seven pins and the secondary side has six pins, so it can only go in one way. That completes the PCB assembly.

Trim the self-adhesive front panel label to size, as shown by the black outline. Before you attach it to the lid, you may wish to use it as a template for drilling a hole for the power switch. The front panel label is positioned in the upper left corner of



Do not adjust VR1 fully clockwise by rotating the adjustment screw, as this sets the low battery shut-down at its highest voltage and with a 12V supply puts the circuit into low battery shut down straight after powering up.

F: It's almost inevitable that there will be some J-B Weld oozing out from under the flange. The secret: apply only as much pressure as is really needed to ensure the glue spreads right around, then wipe any excess off before it sets.

the lid and goes inside the lid to protect it from water. Confirm that the switch will clear the PCB mount components. Drill the hole and apply the self-adhesive label. The hole for switch S1 is then cut out of the panel label using a sharp hobby knife.

Holes are required in one side of the box for the power lead cable gland and for the sockets for connection to the ultrasonic transducers.

Secure the PCB into the box with M3 x 6mm screws before mounting the sockets and cable gland for the power lead. Wire up the sockets, switch and supply leads as shown in Fig.5 and the internal photos. Use 70-80mm lengths of mains-rated wire from CON1/CON2 to the panel-mount sockets. Insulate the connections at the socket end with heatshrink tubing. Attach the switch to CON3 and wire a suitable length of power cable that will go to the battery, to CON3.

When fitting the lid, use the neoprene seal and four stainless screws which came with it.

Installation in the boat

For installation, you need a few extra parts, including a 50mm BSP flanged back-nut for each transducer. This is secured to the hull using J-B Weld 2-part epoxy (Jaycar NA-1518), providing an anchor for the transducer that screws into the flanged back-nut

Additionally, "Fix-A-Tap" waterproof lubricant is required. The back-nut and lubricant are available from plumbing suppliers. You will also need a tub or tube of Vaseline (aka petroleum jelly).

The Ultrasonic Anti-fouling MkII case needs to be mounted on a bulkhead or other position where it is not likely to be splashed or immersed in any water which may be in the bilge. The encapsulated transducer or transducers must be installed inside the hull. For a single transducer, mount it near the running gear (ie, propellers and rudders). Where two transducers are used, one is placed near the running gear and the other toward the bow of the boat. Catamarans will require one transducer per hull, both placed near the running gear.

First, you must find a suitable flat section of the hull and on many boats – this will not be easy. Try temporarily positioning the flanged back-nut in a number of positions to get the best spot.



G: Once set (24 hours +), the transducer assembly is screwed into position with a good big dollop of Fix-A-Tap lubricant on the face. But before doing so, wind it anti-clockwise a number of turns.



H: The location for the driver unit is just as important as the transducer. It must be one which can NEVER interfere with any boat operation and one which won't be stepped on if you need to get into the area.

BLANK

use Araldite or any other epoxies. We want to be sure of a reliable long-term bond to the hull which won't let go with constant ultrasonic, engine and propeller vibration. [see Photo E below].

Apply a liberal coating of petroleum jelly (or Vaseline) to the thread of the flanged back-nut, as in pic B. We don't want any epoxy resin to adhere to the threads, otherwise, the flange will not be usable. Apply the mixed epoxy resin to the roughened surface of the flange, as in photo E. Then press it down onto the previously prepared section of the hull. Leave it to set for 24 hours, or longer in cold temperatures. Refer to the instructions supplied with the J-B Weld adhesive.

Some adhesive will probably ooze out from under the flange. This doesn't matter too much, apart from aesthetics. Inside, though, it should be carefully cleaned away without getting it on the thread of the flanged back-nut. That's so that the transducer (when fitted) will not sit proud of the hull.

Installing the driver unit

The next step is to install the ultrasonic driver unit. Its IP65 plastic case has internal provision for four mounting screws, near the screws which attach the lid. To fit them, you need to remove the transparent lid of the case and position the unit in the spot where it is to be mounted. Preferably, it should be on a vertical bulkhead above the waterline, say

Trim the self-adhesive front panel label to size, using the black outline.

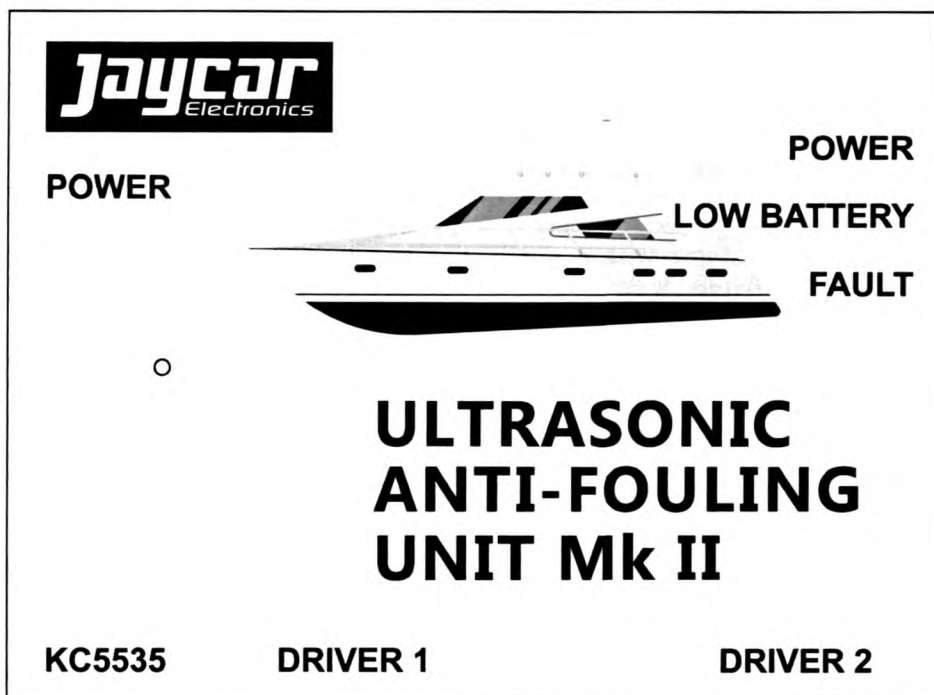

Jaycar Electronics

POWER **POWER**
LOW BATTERY
FAULT

ULTRASONIC ANTI-FOULING UNIT Mk II

KC5535 DRIVER 1 DRIVER 2

between the engine compartment and the lazarette. It is most important that the ultrasonic driver unit is mounted above any likely spray or splashes from water in the bilge.

On no account should you drill holes in the hull to mount the ultrasonic driver. Photo I overleaf shows the ultrasonic driver being mounted in place. **You must use AS316-grade stainless steel screws**; anything else will quickly corrode. Having mounted the ultrasonic driver in place, you are ready to install the encapsulated transducer or transducers to their flanged back-nut

Inevitably, this will involve running cable through parts of the boat structure.

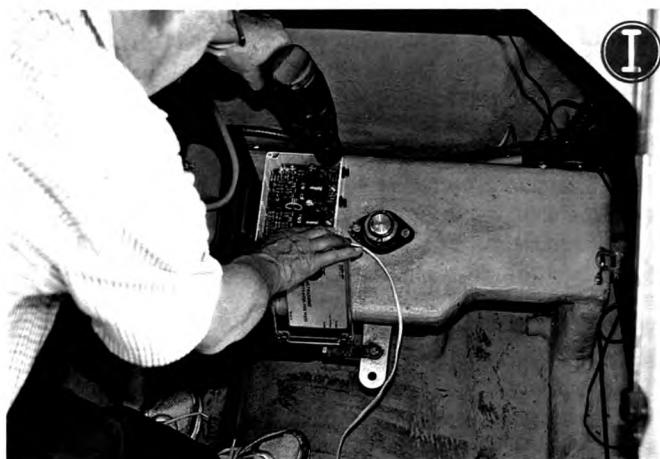

I: Use the case itself (with the lid off!) as a template to mark your drilling positions, then move the case and drill the holes to mount the driver electronics.

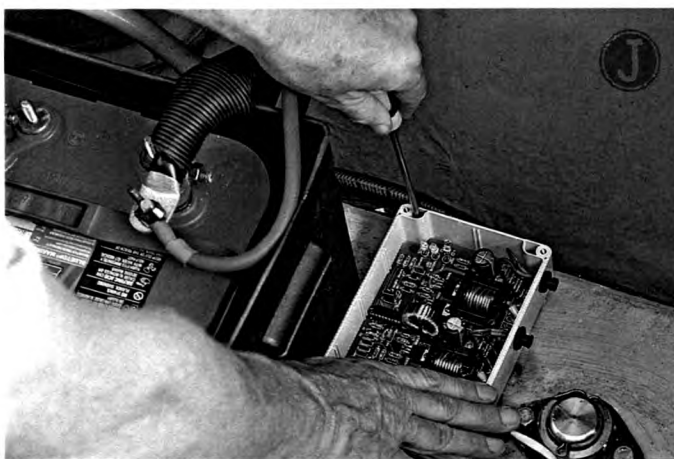

J: Use good quality marine stainless steel screws for securing the case to its mounting position. A power screwdriver is a good idea here: we didn't have the right bit and screwing into the fibreglass was really tough going.

If you can run the cable next to existing cable, so much the better. Lace or tie the cable into position where possible. It should not be allowed to flap about or hang in loose loops.

Again, remember that boats experience severe vibration and we don't want the cable to fail in the long term; see photo K below.

You may have to drill holes in bulkheads to run the transducer cable through. If so, smooth off rough edges and fit suitable grommets to protect the cable from chafing.

When the J-B Weld has cured, we can return to the transducer mounting. First, liberally coat the face of the encapsulated transducer with a non-hardening grease. We suggest "Fix-A-Tap" waterproof lubricant which can be readily obtained from hardware stores. This is applied to fill any voids when the transducer housing is screwed down into the flange.

Before screwing in the transducer, twist it anti-clockwise for the same number of turns as it takes to screw it in so that when the transducer is installed, the cable is in its natural (untwisted) position.

Do not over-tighten it but make sure that it is tight enough that it is not likely to shake loose over time. Then make sure that the transducer cable is neatly routed and cannot possibly interfere with the operation of any moveable parts such as the rudder gear.

Finally, you need to make the supply connections to the house battery. Again, lace and anchor the supply cable securely. There is no need for an in-line fuse since there is already a 3A fuse within the Ultrasonic Anti-fouling MkII unit.

Must nots

The electrical systems of boats are not nice places for electronic devices. Very high spike voltages can be generated by solenoids, electric winches, starter motors and particularly from bow and stern thrusters which pull very high currents.

With this in mind, you must connect to the ultrasonic anti-fouling unit directly to the terminals of the house battery and not somewhere else in the harness where it might be subjected to spike voltages from anchor winches, solenoids or any other nasties. We know of one user who connected the previous version of the ultrasonic anti-fouling

unit across the starter motor terminals – it did not live long!

More importantly, don't even think about running your ultrasonic anti-fouling unit from the batteries for your bow and stern thrusters. On our own prototype unit, our trusty boat electrician thought he was doing us a favour by connecting the anti-fouling unit to the much larger battery for the stern thruster. We don't know how long it lasted before the supply input components failed. Don't do it!

Note that since the unit is intended to run continuously, the battery needs to be kept charged. Preferably, a 3-state charger should be used powered via mains power (if shore power is available), solar panels or a wind turbine.

When power is applied to the Anti-fouling unit, the green power LED should light. After about 30 seconds, this LED should flash and the neon indicators will flash in unison, to indicate that the transducer(s) are being driven.

Where do you get a kit of parts?

The Ultrasonic Anti-fouling Unit MkII has been developed in conjunction with Jaycar Electronics and will not be available from any other suppliers.

Kits should be available from all Jaycar stores and some resellers from this month.

SINGLE TRANSDUCER KIT: (Cat KC5535)

SECOND TRANSDUCER KIT: (Cat KC5536)

* Single transducer kits contain only those components necessary to build a single transducer unit. This includes the waterproof case and one transducer. They DO NOT include Vaseline or waterproof lubricant

**Second transducer kits contain the second transducer plus Q3, Q4, ZD3, ZD4, D3, D4, D6, NEON 2, T2, CON2 and associated resistors/capacitors, as shown on the circuit and PCB.

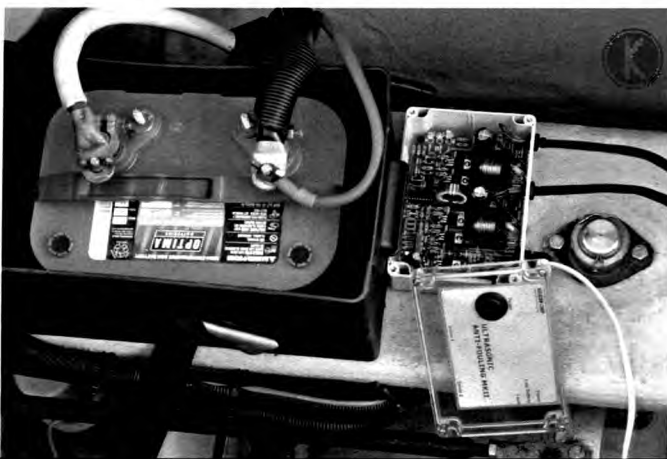

K: after mounting, connect to an appropriate battery (one that receives shore power or solar panel charging). Dress the leads so that they can't move around (remember that there is severe vibration present).

Ultrasonic Anti-fouling FAQs

Q: How big a boat can the unit handle?

A: The single transducer design and driver presented here is suitable for boats up to 8 metres long. Longer boats, say up to 14 metres, will require two transducers. Boats bigger than 15 metres, say up to 20 metres, will require at least three and maybe four transducers and drivers.

Catamarans up to 10 metres long will require a separate transducer and driver unit for each hull.

Q: Do I need to cut a hole in the hull for the transducer?

*A: You must **not do this** or do anything else to prejudice the integrity of the boat's hull. This is particularly important for boats with fibreglass or composite (sandwich) construction. The encapsulated transducer is mounted on a flat surface inside the hull. For a boat up to 8 metres, the transducer should be mounted near the running gear (ie, propellers & rudders) so that it offers maximum protection from marine growth.*

For longer boats, fit one transducer near the running gear and the other closer to the bow.

Q: Is ultrasonic anti-fouling suitable for all boats?

A: No. Ultrasonic anti-fouling relies on one or more transducers mounted inside the hull to excite it at various frequencies in order to disrupt the cell structure of algae. It works well with metal hulls such as aluminium and with fibreglass hulls. It does not work with timber hulls as the timber is not a good conductor of ultrasonic energy. The same comment applies to ferro-cement or fibreglass hulls with a balsa sandwich or other composite construction (eg, closed-cell PVC foam).

Q: Is it necessary for the boat's hull to be cleaned of marine growth and conventionally anti-fouled before the ultrasonic anti-fouling system is installed?

A: Yes. Ultrasonic anti-fouling is unlikely to kill shell fish or molluscs already attached to the hull. Nor will it cause them to detach from the hull. Hence, there is no alternative to having the hull water-blasted to clean off all existing marine growth.

And if it is already on the slips for such cleaning and other maintenance such as servicing outboard legs and replacing sacrificial anodes, it makes sense to have conventional anti-fouling paint applied,

although this may be regarded as optional.

We should also emphasise that, no matter how effective ultrasonic anti-fouling may be in keeping the hull clean of marine growth, it will still be necessary to do regular maintenance such as the servicing of outboard legs (in case of boats with inboard/outboard motors) and replacing sacrificial anodes.

Q: Does the ultrasonic anti-fouling unit present a risk of electric shock?

A: No. As stated in the circuit description, the ultrasonic transducer is driven with peak voltages up to 800V. If you make direct contact with the circuit or the ultrasonic transducer there is a very high probability that you will receive a severe electric shock. That is why the transducer itself must be completely encapsulated in a plastic fitting. This prevents anyone from getting a shock from the system.

Q: Will ultrasonic anti-fouling keep propellers, rudders and other "running gear" free of marine growth or is it still necessary to use anti-fouling compounds such as PropSpeed?

A: Ultrasonic anti-fouling will help keep props and rudders free of marine growth but it won't necessarily be the complete answer. Our experience is that PropSpeed is still worthwhile.

Q: Does ultrasonic anti-fouling cause increased electrolytic leakage currents (electrolysis) and thereby increase corrosion on boats?

A: No. The ultrasonic transducer and driver unit are installed entirely within the hull of the boat and the ultrasonic transducer itself is transformer driven and is completely encapsulated to provide a high degree of insulation. There should be no leakage currents at all.

Q: Is ultrasonic anti-fouling equipment likely to cause damage to the hull of a boat, especially those of fibreglass construction? Will it cause osmosis or de-lamination?

A: We know of no research into this topic and while it could be suggested that the continuous, albeit very low-power, ultrasonic vibration of the hull could lead to de-lamination, such ultrasonic vibration is extremely low in amplitude compared with the severe hull vibration caused by propellers and diesel or petrol motors when boats are operating at high power, especially when "on the plane".

Since we published our first Ultrasonic Anti-fouling unit in 2010, we have had a great deal of feedback and lots of questions. Here are the answers.

Furthermore, hulls are placed under very high stresses when boats are being pounded by heavy seas or are repeatedly slammed though waves or hitting wakes of other boats at speed.

Many older fibreglass boats, say more than 25 years old, can be subject to osmosis and de-lamination. Repairs are routine but expensive to carry out and the boat must be out of the water for many months to ensure that any water trapped in hull laminations is removed.

If a boat was fitted with ultrasonic anti-fouling and after years of use, there is subsequent evidence of hull osmosis or de-lamination, it would be impossible to determine if it were caused by normal wear and tear or other causes.

Ultrasonic anti-fouling is routinely fitted to brand new boats but anyone contemplating such an installation would be wise to check that hull warranties are not invalidated. We make no warranties that ultrasonic anti-fouling does not cause hull damage.

Q: Does ultrasonic anti-fouling harm fish or marine mammals?

A: This system causes no harm to fish or to marine mammals. Fish cannot hear it and while marine mammals certainly can perceive and respond to ultrasonic signals, they are not harmed in any way by the relatively low power levels which are likely to be radiated by the hull of the boat.

Furthermore, the signal levels are much lower than those directly radiated by depth sounders and fish finders.

Q: Will my boat batteries be damaged by the ultrasonic driver unit?

A: No. The ultrasonic driver circuitry described last month incorporates battery protection. If the battery is discharged to 11.5V, the circuit is disabled and will not resume operation until the battery is recharged.

However, since the ultrasonic anti-fouling driver is designed to operate continuously, the battery supplying it will need to be on permanent float charge. This will require 230VAC shore power if you are fortunate enough to have your boat in a pen or marina berth.

If your boat is on a swing mooring or is otherwise without shore power, then a solar panel and suitable charger will be needed to keep the battery up to charge.

Q: How big a solar panel will be required to keep the battery sufficiently charged?

A: The continuous power drain of the ultrasonic driver is about 5W or less for one transducer and less and 9W

for a 2-transducer version, depending on the actual supply (the peak powers applied to the transducers are much higher, at around 40W or more).

To provide this level of power on a continuous basis, you will need a solar panel installation of at least 20W. Many boats on swing moorings would already have such a solar panel but it would need to be augmented by at least another 20W to be sure that the battery is fully charged during periods of bad weather or in winter when there are less hours of sunlight.

Q: Will I be able to hear the ultrasonic anti-fouling unit in operation, especially at night when the water is very still?

A: Probably not. Unless you are a bat(!), you cannot hear ultrasonic frequencies directly. However, the transducers and the driving transformers do emit high frequencies and clicks at low levels. These are actually sub-harmonics of the ultrasonic signals and are most evident as the frequencies are continuously shifted up and down over the operating spectrum.

However, once the unit is installed, you will only be able to hear these sounds, if at all, by placing your ear directly over the ultrasonic driver or over the transducer. You might also be able to feel some slight vibration of the transducer itself.

On the other hand, divers underneath boats fitted with ultrasonic antifouling often report unpleasant pressure sensations in the ears. So if you have a diver underneath the boat for any reason, turn off the anti-fouling unit. Just remember to turn it back on when the job is finished!

Q: Will the ultrasonic anti-fouling cause interference to radio operation on my boat?

A: If you place a portable AM radio on top of the ultrasonic anti-fouling driver unit, you should be able to hear evidence of its operation as a continuously shifting squeal. However, at even small distances away from the driver, such interference should be negligible.

No interference will be caused to marine radio communications or to broadcast FM or TV reception, or to digital TV or DAB+ reception.

Q: Will the ultrasonic anti-fouling unit interfere with the operation of depth sounders or fish finders?

A: No.

56

COMPONENT IDENTIFICATION

This section will help you to match some of the symbols used in schematics (electronic circuit diagrams) to the physical component used in the actual product. You will see the symbol on the left and the component on the right.

RESISTORS



VARIABLE RESISTORS

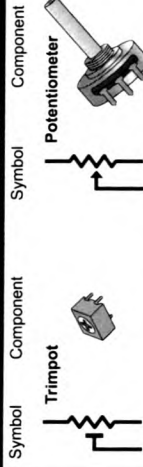

CAPACITORS

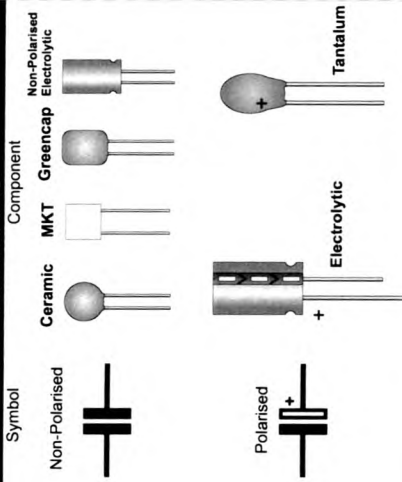

DIODE / ZENER DIODE

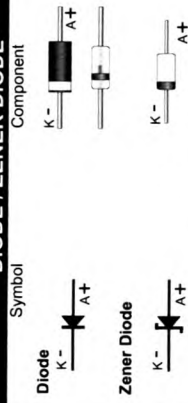

BRIDGE RECTIFIER

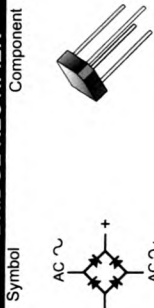

COMPONENT IDENTIFICATION

LED'S



INTEGRATED CIRCUIT (IC)

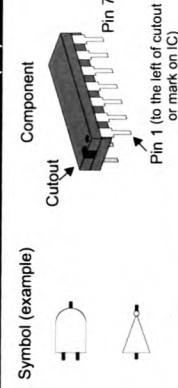

TRANSISTORS

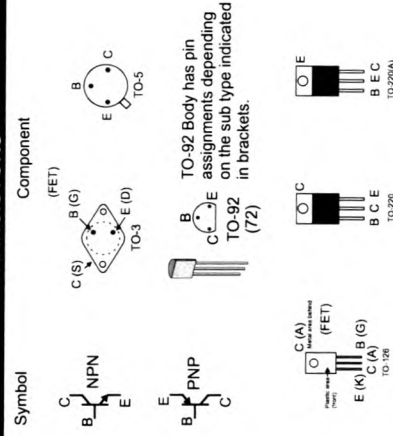

COMPONENT IDENTIFICATION

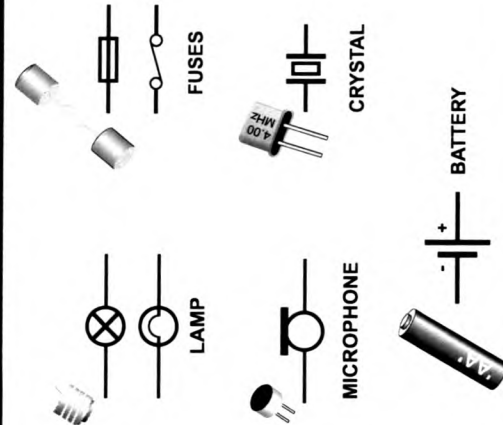

COMPONENT IDENTIFICATION

VOLTAGE REGULATORS

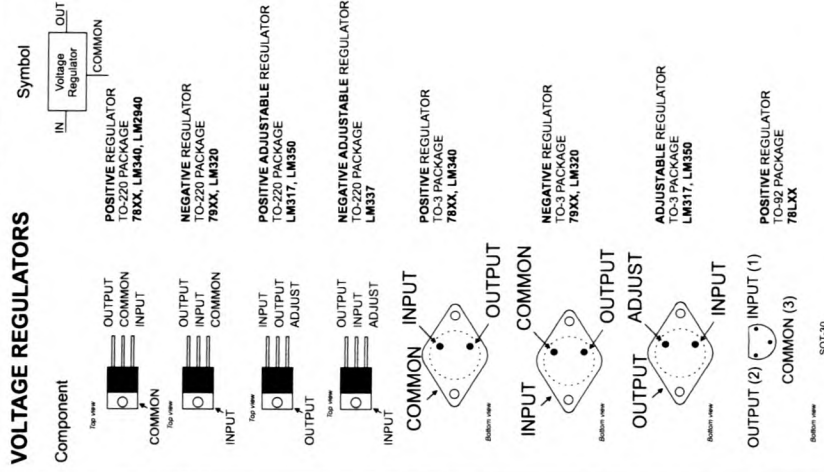

OHM'S LAW

The most basic law in electronics. The relationship between resistance, voltage and current is determined by Ohm's Law (*). If you know two out of the three values you can work out the third.

$$V = I \times R$$

$$I = V / R$$

$$R = V / I$$

The formulas are:

V is Voltage
I is Current in Amps and
R is resistance in Ohms

Jaycar
Electronics

No 1 for Kits

kits@jaycar.com.au

COMPONENT REFERENCE CHART

Ver 1.2 - 24.03.2010

RESISTOR COLOUR CODES

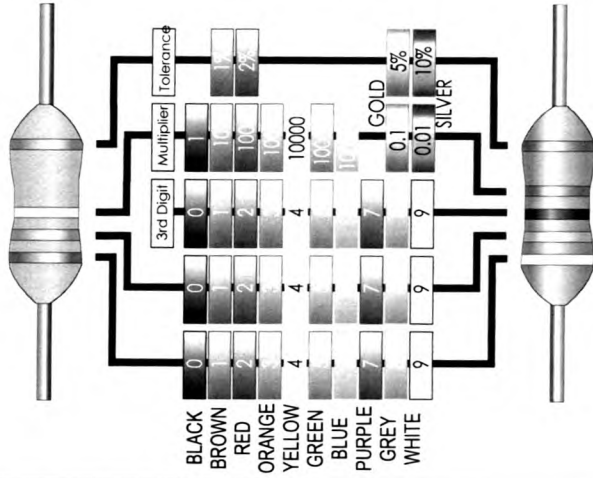

CAPACITOR CODES

Microfarads (u)	Nanofarads (n)	Picofarads (p)	EIA code
-	-	100pF	101
0.22nF	220pF	220pF	221
0.0047uF	4.7nF	4700pF	472
0.01uF	10nF	10000pF	103
0.047uF	47nF	-	473
0.1uF	100nF	-	104
0.47uF	470nF	-	474
1uF	1000nF	-	105

ZENER DIODES (1 WATT UNLESS SPECIFIED)

Part no.	Voltage	Part no.	Voltage
1N4728	3V3	1N4745	18V
1N4729	3V6	1N4746	18V
1N4730	3V9	1N4747	20V
1N4731	4V3	1N4748	22V
1N4732	4V7	1N4749	24V
1N4733	5V1	1N4750	27V
1N4734	5V6	1N4751	30V
1N4735	6V2	1N4752	33V
1N4736	6V8	1N4753	36V
1N4737	7V5	1N4754	38V
1N4738	8V2	1N4755	39V
1N4739	9V1	1N4756	43V
1N4740	10V	1N4757	47V
1N4741	11V	1N4758	51V
1N4742	12V	1N4759	56V
1N4743	13V	1N4760	62V



Specialists in electronic kits, components and products.

KC5536: KIT - U/SONIC ANTIFOULING 2ND CH ADD-ON 05/17

Rev 1

KC5536: KIT - U/SONIC ANTIFOULING 2ND CH ADD-ON 05/17

Silicon Chip Magazine May 2017 (p74 to p83) and Jun 2017 (p66 to p75)

Rev 1

Batch No: **8H8061**

PLEASE READ BEFORE COMMENCING CONSTRUCTION

The guarantee on this kit is limited to the replacement of faulty parts only, as we cannot guarantee the labour content you provide. Our Service Department does not do general service on simple kits and it is recommended that if a kit builder does not have enough knowledge to diagnose faults, that the project should not be started unless assistance can be obtained. Unfortunately, one small faulty solder joint or wiring mistake can take many hours to locate and at normal service rates the service charge could well be more than the total cost of the kit.

If you believe that you may have difficulty in building this kit (which is simply a complete set of separate parts made up to a list provided by the major electronics magazines) and you cannot get assistance from a friend, we suggest you return the kit to us IN ITS ORIGINAL CONDITION for a refund under our satisfaction guarantee. Unfortunately, kits cannot be replaced under our satisfaction guarantee once construction has been commenced.

CONTACTS:

For queries with regards to the design aspects of this project please contact the Project Designer. It is recommended to check the designers/publishers website for further updates since this document was issued. Silicon Chip Publications, POBox 138, Collaroy Beach, NSW 2097, Tel: +61-2-99393295, Fax: +61-2-99392648 www.siliconchip.com.au, silchip@siliconchip.com.au

For quality issues please contact the Production Manager at Jaycar Electronics and provide the following information:

- Product Number
- Batch No
- Details of Quality Issue

Notes and Errata (at time of print):

- Jaycar Electronics: uses netlists to confirm that the PCB artwork matches the schematic(s) and parts list(s) published.
- Observed variations are verified and incorporated into the kit but may not be published by Silicon Chip.
- upgrades the original PCB design to use component footprints, possible component shape, value and lead configuration alternatives and aligned polarized components where possible.
- You may wish to bend component leads and use component pads further apart.
- has updated the project article with relevant notes and errata. It will therefore differ from the original article published in the magazine.
- Only included the PCB overlay with this kit, as full instructions are supplied with the main kit KC5535.
- recommends to check the designers/publishers website for further notes and errata since this document was issued, before starting construction.

Possible Substitutions		
Original Part	Original Part Desc	Subst Part
N/A		Subst. Part Desc.

PARTS LIST
Please note that catalogue numbers refer to suitable products from the Jaycar product range. Quantities listed refer to the actual number of items required. When purchasing items separately, take pack quantities into account.
* See section about Substitution * See section about Notes & Errata * Processed Panel not part of Case listed
Catalogue numbers starting with "E" or listed as "Special Order" (incl. processed panels) are Kit specific and may not be readily available.

For queries with regards to the design aspects of this project please contact the Project Designer at Silicon Chip (tel: +61-2-99393295 or email: silchip@siliconchip.com.au).

CONTROL PCB

RESISTOR(S)

Cat.#	Qty*	Description	Component Ident	And/O'r Location
ER9448	1	RES 0.25W CARB 220K 1.6KV 5%	Red	Red Yellow Yellow
RR0524	2	RES 0.5W MTL 10R 1%	Brown	Black Black Gold Brown
RR0596	2	RES 0.5W MTL 10K 1%	Brown	Black Black Red Brown
RR0623	1	RES 0.5W MTL 130K 1%	Brown	Orange Black Orange Brown

CAPACITOR(S)

Cat.#	Qty*	Description	Component Ident	And/O'r Location
ER9449	1	CAP CER F 1N 2KV 5% P=5MM	1n / 1000p / 102	
RE6330	1	CAP ELECT 2200U 25V 105C U/ESR 16X25	2200uF / 25V U/ESR	

SEMICONDUCTOR(S)

Cat.#	Qty*	Description	Component Ident	And/O'r Location
EZ9411	2	MOSFET HUF76423P3 60V 33A N-CH TO220	HUF76423P3 / Peray	74623P Q3, Q4
ZR1020	2	DIODE 1N5819 SCHOTTKY 40V 1A DO41	IN5819 / SOD 81	D3, D4
ZR1038	1	DIODE UF4007 1000V 1A U/FAST DO41	UF4007	D6
ZR1403	2	DIODE ZENER 1N4733 5.1V 1W DO41	1N4733 (5V1)	ZD3, ZD4

HARDWARE / WIRE(S) / MISCELLANEOUS

Cat.#	Qty*	Description	Component Ident	And/O'r Location
HM3132	1	TERMINAL PCB SCREW 3WAY P=5.08MM ORG		CON2
HP0403	2	SCREW M3X10MM PHIL R/HD SP	Mount MOSFET	
HP0425	2	NUT M3 SP	Mount MOSFET	
HP0433	2	WASHER MTL M3 S/PRF INTT/ SLV	Mount MOSFET	
NS3015	50cm	SOLDER 60/40 1MM		
PP0542	1	PLG PNL IP67 LTW 2PIN 5A		
SL2695	1	GLOBE NEON NE2 BLU 90V PIGTAIL		NEON2
WH3040	15cm	CABLE HU RND 24X0.2MM H/D RED	Transducer ---	Colour may vary for high voltage parts and transducer socket
WH5551	10cm	HEATSHRINK 2.5MM X 1.2M CLR		
WH5554	2cm	HEATSHRINK 6MM X 1.2M CLR		

HARDWARE / WIRE(S) / MISCELLANEOUS - LOOSE

Cat.#	Qty*	Description	Component Ident	And/O'r Location
EH1937	1	NUT HANSEN LARGE BACK BLACK 50MM PLASTIC		
EM2791	1	T/F (KC5498/KC5499) ETD29 3C85 BIFILAR		
NA1518	1	GLUE EPOXY J-B WELD JB8270 2X28G TUBE		
YS5605	1	SPARE TRANSDUCER [YS5600/5602] COMPLETE		

REQUIRED

Cat.#	Qty*	Description	Component Ident	And/O'r Location
KC5535	1	KIT - U/SONIC ANTIFOULING BOAT SGL 05/17		

KC5536 - KIT - U/SONIC ANTIFOUL BOAT 2ND CH 05/17

This kit contains the parts to upgrade the KC5535, single channel ultrasonic antifouling project for boats, to a dual channel system. Full assembly instructions are provided with the kit KC5535, therefore only PCB overlay and schematic are included with this kit.

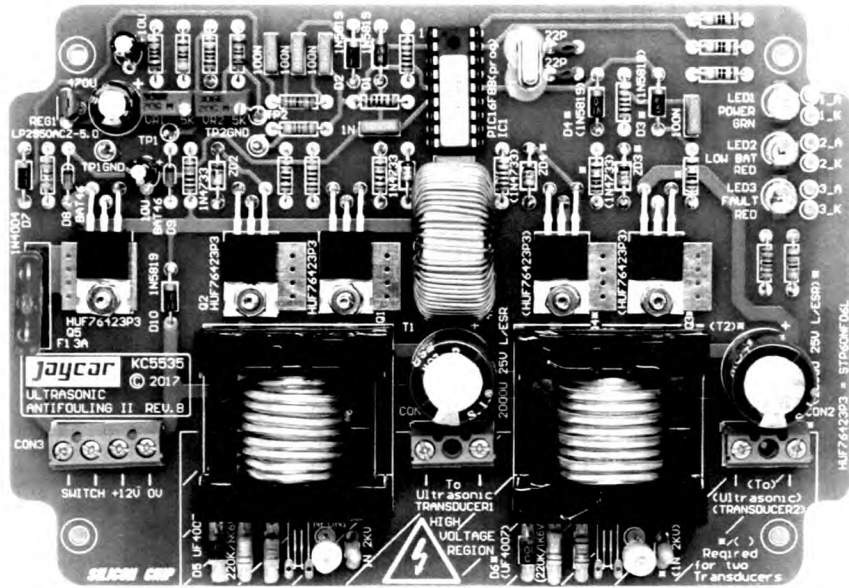

The Ultrasonic Anti-Fouling Unit can be built to drive one or (as shown here) two ultrasonic transducers. If your craft is less than 8m long, you should be able to get away with one – in which case, the majority of components on the bottom right of this photo are not installed.

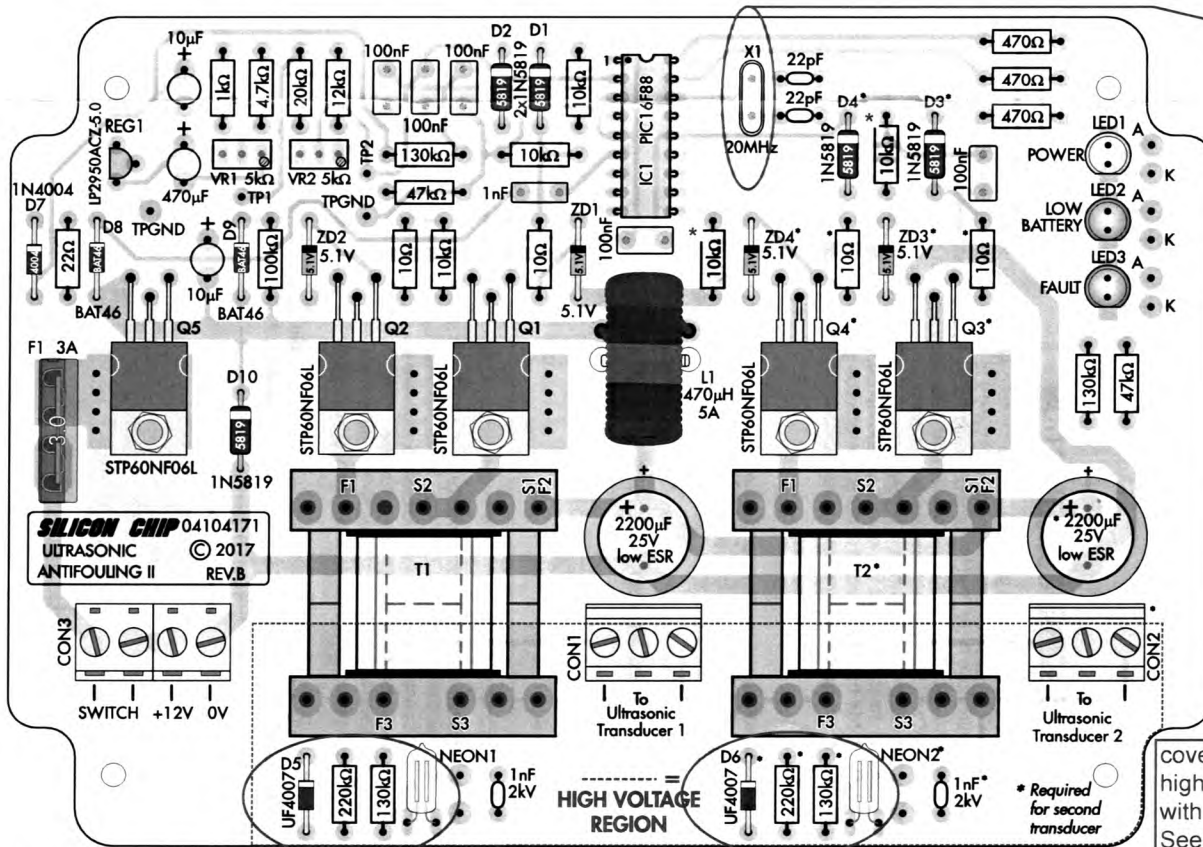

use two nylon washers as spacers if the top layer PCB pads can short to the crystal case!

cover exposed high voltage leads with heatshink! See text.

Fig.5: component overlay for the two transducer version of the Ultrasonic Anti-Fouling Unit, MkII. To build the single transducer version, simply leave out all components in the light yellow section of the PCB – Q3, Q4, ZD3, ZD4, D3, D4, D6, NEON2, T2, CON2 and associated resistors/capacitors. Note the area of the PCB with a dashed red border/light pink background has high voltages on both the tracks and component leads when operating.

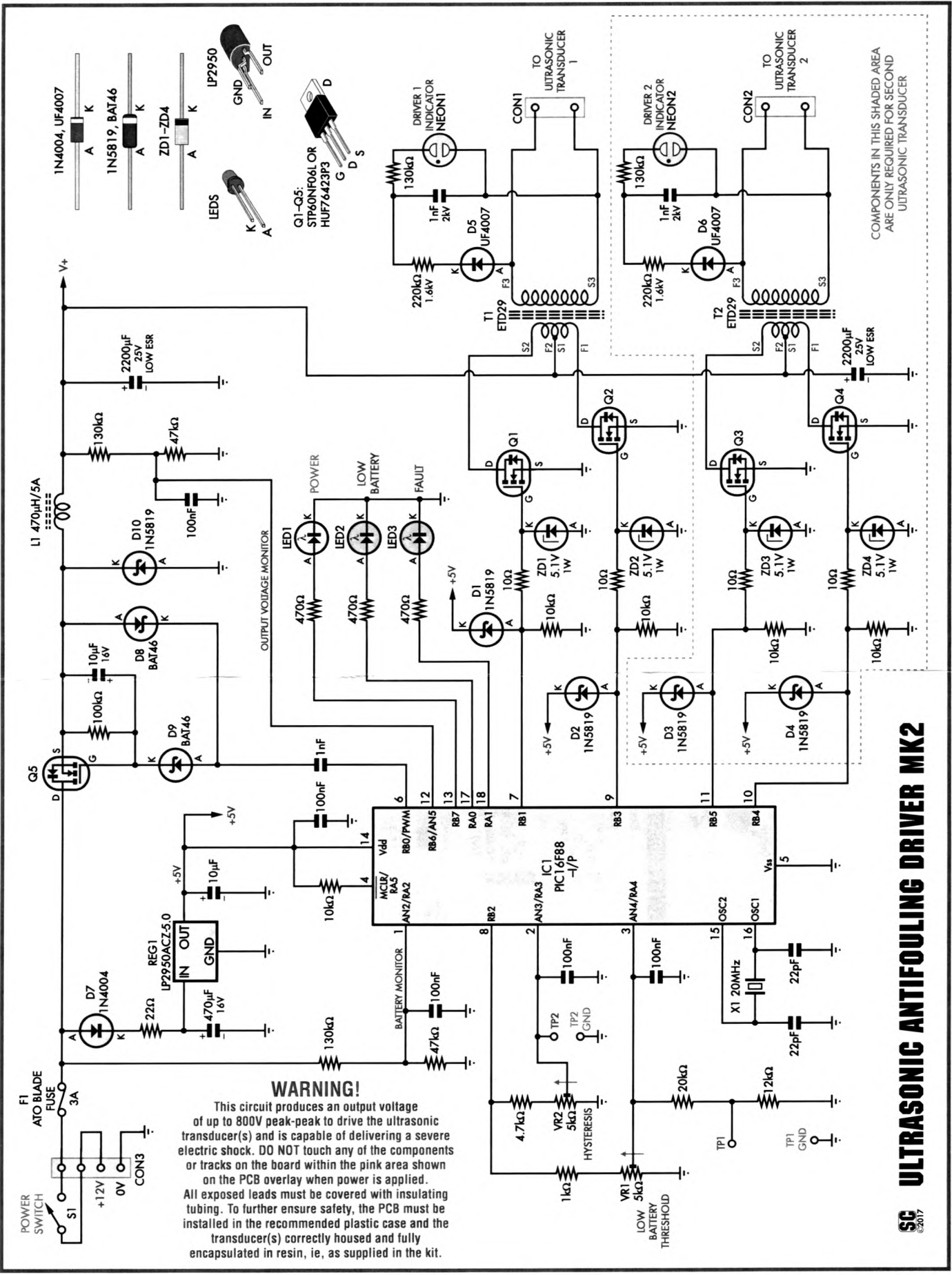

- 1N4004, UF4007
- 1N5819, BAT46
- ZD1-ZD4
- LP2950
- LEDS
- Q1-Q5: STP60NF04 OR HUF76423P3

COMPONENTS IN THIS SHADED AREA ARE ONLY REQUIRED FOR SECOND ULTRASONIC TRANSDUCER

WARNING!
 This circuit produces an output voltage of up to 800V peak-peak to drive the ultrasonic transducer(s) and is capable of delivering a severe electric shock. DO NOT touch any of the components or tracks on the board within the pink area shown on the PCB overlay when power is applied. All exposed leads must be covered with insulating tubing. To further ensure safety, the PCB must be installed in the recommended plastic case and the transducer(s) correctly housed and fully encapsulated in resin, ie, as supplied in the kit.

ULTRASONIC ANTIFOULING DRIVER MK2



COMPONENT IDENTIFICATION

This section will help you to match some of the symbols used in schematics (electronic circuit diagrams) to the physical component used in the actual product. You will see the symbol on the left and the component on the right.

RESISTORS

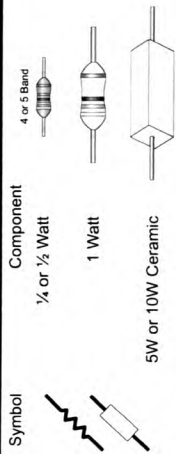

VARIABLE RESISTORS

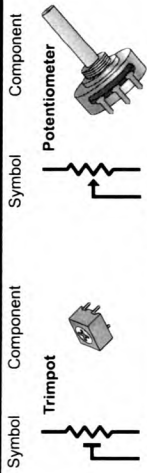

CAPACITORS

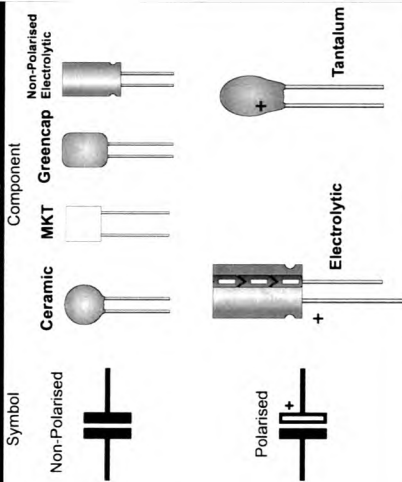

DIODE / ZENER DIODE

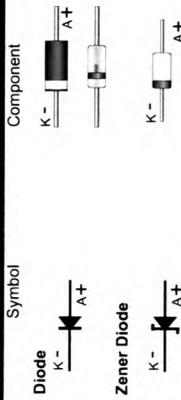

BRIDGE RECTIFIER

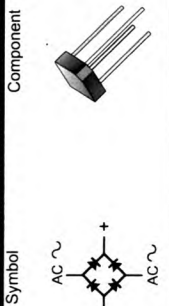

COMPONENT IDENTIFICATION

LED's



INTEGRATED CIRCUIT (IC)

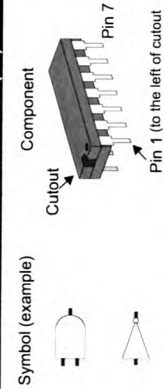

TRANSISTORS

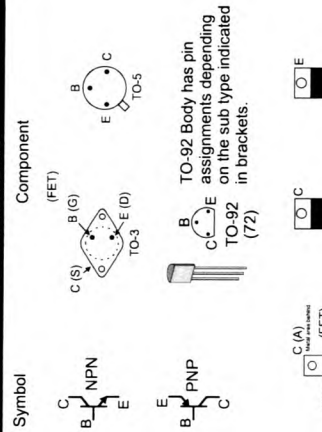

COMPONENT IDENTIFICATION

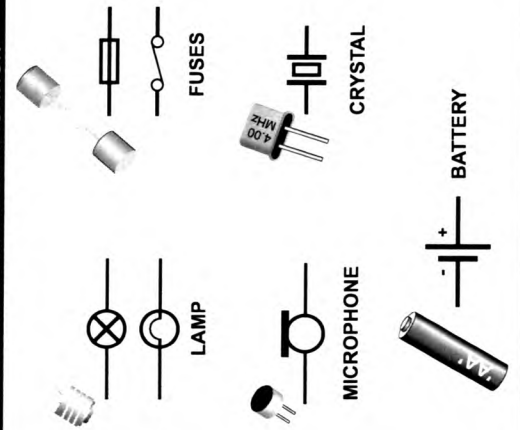

COMPONENT IDENTIFICATION

RESISTOR COLOUR CODES

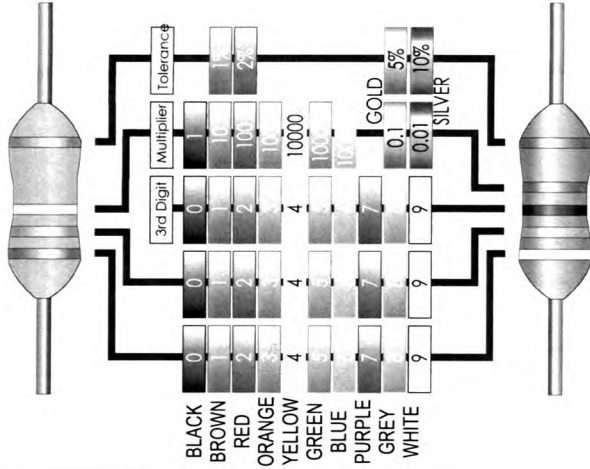

Examples:

(5 BAND) yellow-purple-black-brown-brown = 4-7-0-1-1% = 4K7 1%

(4 BAND) orange-purple-yellow-gold = 3-7-4-10% = 370K 10%

CAPACITOR CODES

Microfarads (u)	Nanofarads (n)	Picofarads (p)	EIA code
0.001uF	0.22nF	100pF	101
0.0047uF	1nF	220pF	221
0.01uF	4.7nF	1000pF	102
0.047uF	10nF	4700pF	472
0.1uF	100nF	-	103
0.47uF	470nF	-	473
1uF	1000nF	-	104
			474
			105

ZENER DIODES (1 WATT UNLESS SPECIFIED)

Part no.	Voltage	Part no.	Voltage
1N4728	3V3	1N4744	15V
1N4729	3V6	1N4745	16V
1N4730	3V9	1N4746	18V
1N4731	4V3	1N4747	20V
1N4732	4V7	1N4748	22V
1N4733	5V1	1N4749	24V
1N4734	5V6	1N4750	27V
1N4735	6V2	1N4751	30V
1N4736	6V8	1N4752	33V
1N4737	7V5	1N4753	36V
1N4738	8V2	1N4754	39V
1N4739	9V1	1N4761	75V
1N4740	10V	1N5349B	12V 5W
1N4741	11V	1N5352N	15V 5W
1N4742	12V	1N5374	75V 5W
1N4743	13V		

VOLTAGE REGULATORS

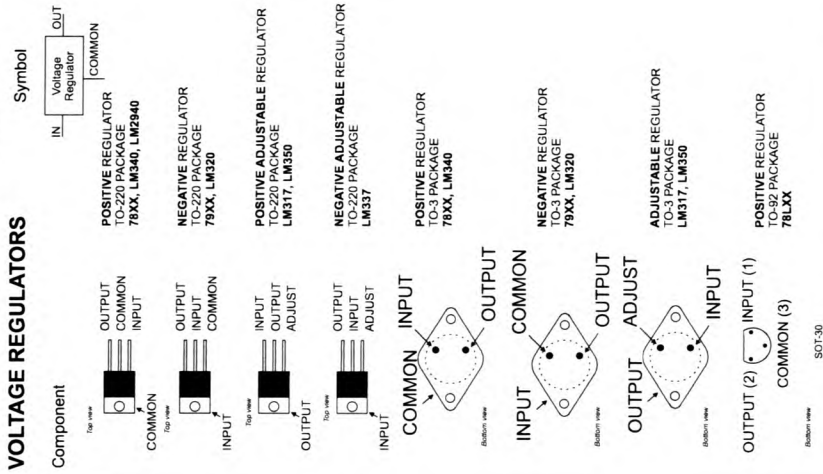

OHM'S LAW

The most basic law in electronics. The relationship between resistance, voltage and current is determined by Ohm's Law (*). If you know two out of the three values you can work out the third.

$$V = I \times R$$

$$I = V / R$$

$$R = V / I$$

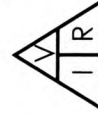

The formulas are:

V is Voltage

I is Current in Amps and

R is resistance in Ohms

Jaycar
Electronics

No 1 for Kits

kits@jaycar.com.au

COMPONENT REFERENCE CHART

Ver 1.2 - 24.03.2010