

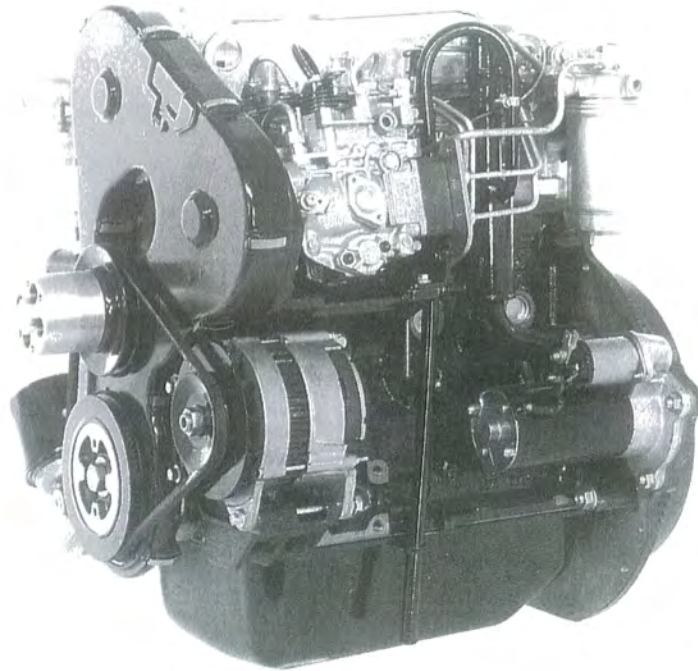

Workshop Manual



**Prima
Prima Marine
500 Series**

Visit Us
at
www.foleyengines.com

FOLEY ENGINES

1-800-233-6539



 **Perkins**
POWER
SERVICE

WORKSHOP MANUAL

- | | |
|---------------------|--|
| Prima | Four cylinder diesel engines for vehicle applications |
| Prima Marine | Four cylinder diesel engines for marine applications |
| 500 Series | Four cylinder diesel engines for agricultural and industrial applications |

*This publication is written in
Perkins Approved Clear English*

PACE

Publication TPD 0192 1273.
© Perkins Group Limited 1992, all rights reserved.
Published by Technical Publications,
Perkins Power Sales and Service Limited, Peterborough PE1 5NA, England.

Amendment status

Number	Description	Date
1	To amend and add information	January 1992

Contents

General information	10
Specifications	11
SERVICE OPERATIONS										
Cylinder head assembly	12
Piston and connecting rod assemblies	13
Crankshaft assembly	14
Timing case and drive assembly	15
Cylinder block assembly	16
Engine timing	17
Aspiration system	18
Lubrication system	19
Fuel system	20
Cooling system	21
Flywheel, flywheel housing and marine reverse gearbox	22
Electrical equipment	23
Auxiliary equipment	24
List of special tools	25

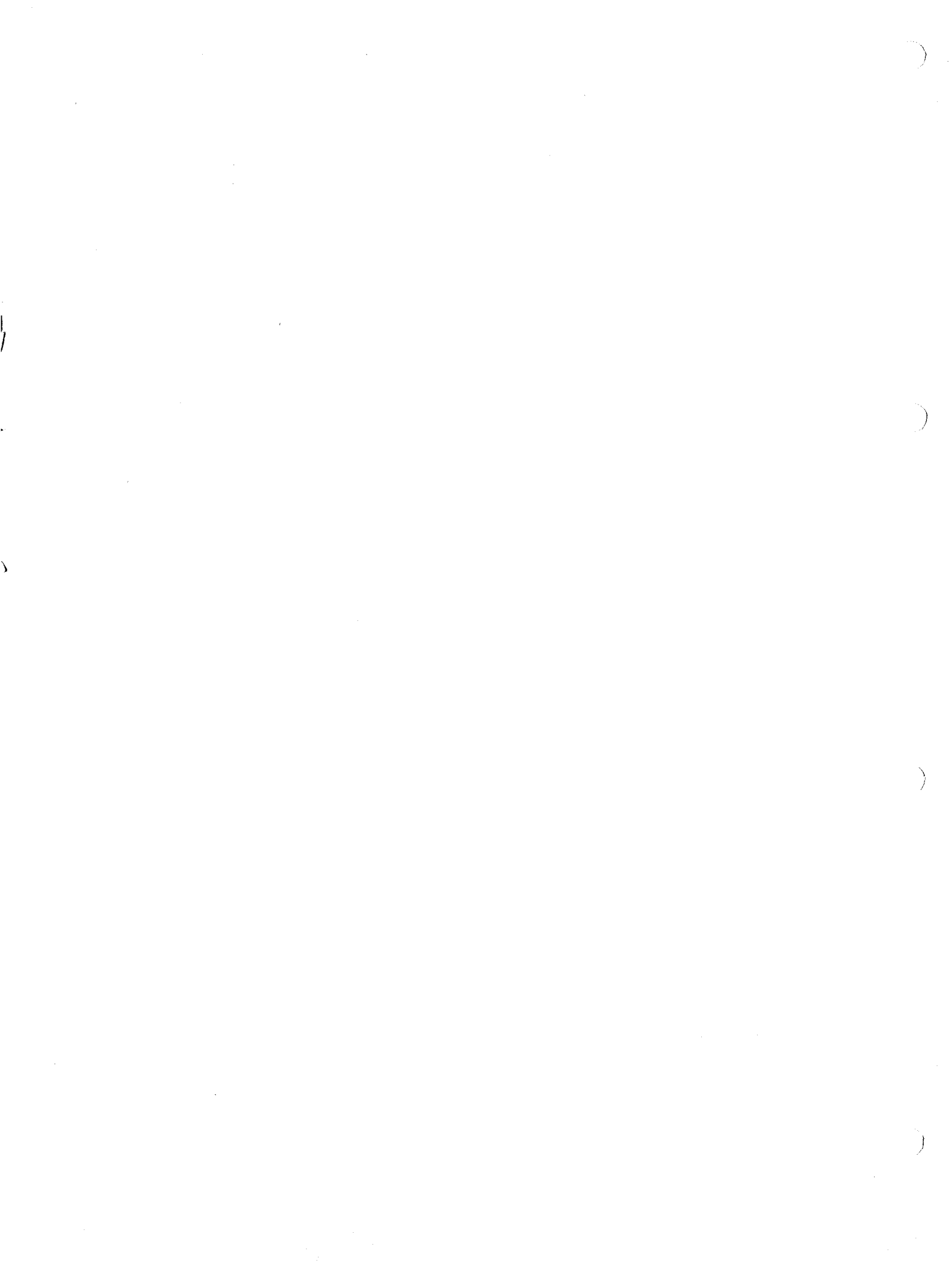

General information

10

Introduction	10.02
Engine identification	10.03
Safety precautions	10.04
Asbestos joints	10.05

Introduction

This workshop manual has been designed to provide assistance in the service and overhaul of Perkins Prima and 500 Series engines.

Most of the general information which is included in the relevant User's Handbook (sections 1 to 9) has not been repeated in this workshop manual and the two publications should be used together.

Where the information applies only to certain engine types, this is indicated in the text.

When reference is made to the "left" or "right" side of the engine, this is as seen from the flywheel end of the engine.

Special tools have been made available and a list of these is given in section 25. Reference to relevant special tools is also made at the beginning of each operation.

All the joints on these engines can be fitted dry unless instructions are given for the application of sealant. Where fasteners are fitted into threaded holes which are open to the inside of the engine, manifolds, etc., a suitable sealant must be applied to the threads. If necessary, sealant is already applied to new fasteners but, if these are used more than once, the threads should be cleaned and new sealant applied.

Read and remember the "Safety precautions". They are given for your protection and must be used at all times.



A hazard symbol in the text indicates that there is a danger of personal injury if certain operations are not done correctly.

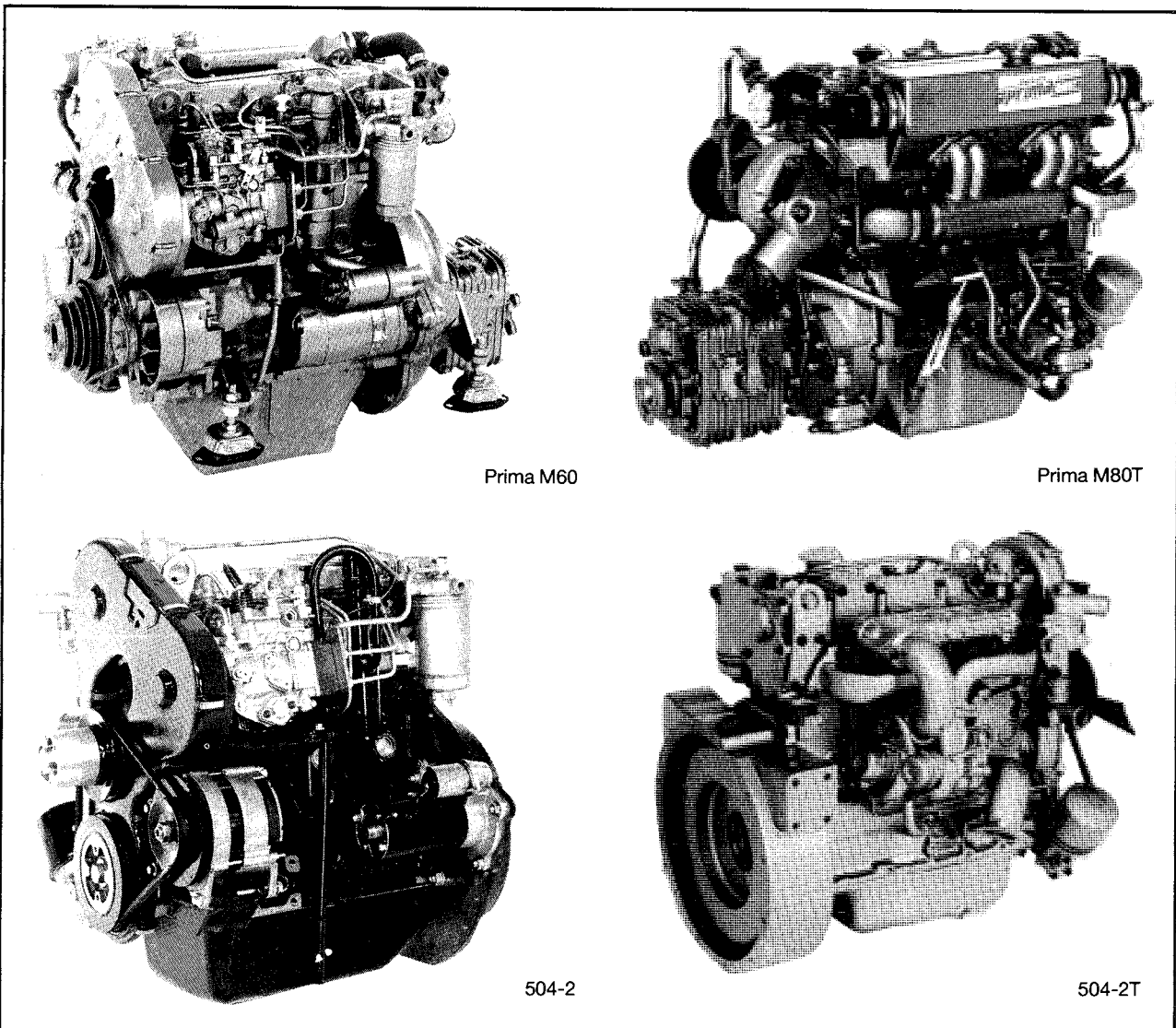

Prima M60

Prima M80T

504-2

504-2T

Engine identification

The Perkins Prima and 500 Series engines have been designed for specific applications, as shown below.

Prima for vehicle applications

Prima Marine for marine applications

500 Series for agricultural and industrial applications

Each series consists of a range of four cylinder engines which are either naturally aspirated or turbocharged.

There are different models in each series.

Prima engines are named according to their approximate power output, for example:

Prima 65 - naturally aspirated vehicle engine rated at 62 bhp

Prima M50 - naturally aspirated marine engine rated at 49 bhp

Prima M80T - turbocharged marine engine rated at 78 bhp

500 Series engines are identified by a system of numbers and letters, for example:

504-2T - four cylinder turbocharged engine of two litres capacity

Further information about the engine number system can be found in the relevant user's handbook.

The information in this workshop manual is relevant to all engine models, unless specifically indicated.

The engine number is stamped on a label which is fastened to the left side of the cylinder block (A1). An example of an engine number is BA50240U523456S.

If you need parts, service or information for your engine, you must give the complete engine number to your Perkins distributor.

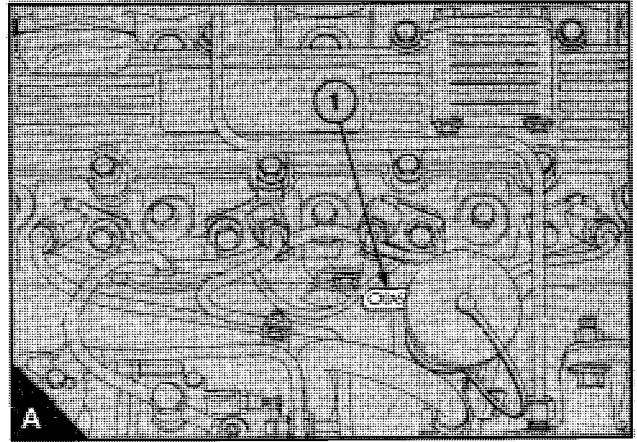

Safety precautions

These safety precautions are important. You must refer also to the local regulations in the country of use. Some items only apply to specific applications.

- Only use these engines in the type of application for which they have been designed.
- Do not change the specification of the engine.
- Do not smoke when you put fuel in the tank.
- Clean away fuel which has been spilt. Material which has been contaminated by fuel must be moved to a safe place.
- Do not put fuel in the tank while the engine runs (unless it is absolutely necessary).
- Do not clean, add lubricating oil, or adjust the engine while it runs (unless you have had the correct training; even then extreme caution must be used to prevent injury).
- Do not make adjustments that you do not understand.
- Ensure that the engine does not run in a location where it can cause a concentration of toxic emissions.
- Other persons must be kept at a safe distance while the engine, or equipment, is in operation.
- Do not permit loose clothing or long hair near moving parts.
- Keep away from moving parts during engine operation.
Attention: Some moving parts cannot be seen clearly while the engine runs.
- Do not operate the engine if a safety guard has been removed.
- Do not remove the filler cap of the cooling system while the engine is hot and while the coolant is under pressure, because dangerous hot coolant can be discharged.
- Do not use salt water or any other coolant which can cause corrosion in the closed coolant circuit.
- Do not allow sparks or fire near the batteries (especially when the batteries are on charge) because the gases from the electrolyte are highly flammable. The battery fluid is dangerous to the skin and especially to the eyes.
- Disconnect the battery terminals before a repair is made to the electrical system.
- Only one person must control the engine.
- Ensure that the engine is operated only from the control panel or from the operator's position.
- If your skin comes into contact with high-pressure fuel, obtain medical assistance immediately.
- Diesel fuel and lubricating oil (especially used lubricating oil) can damage the skin of certain persons. Protect your hands with gloves or a special solution to protect the skin.
- Do not wear clothing which is contaminated by lubricating oil. Do not put material which is contaminated with oil into the pockets.
- Discard used lubricating oil in a safe place to prevent contamination.
- Do not move mobile equipment if the brakes are not in good condition.
- Ensure that the control lever of the transmission drive is in the "out-of-drive" position before the engine is started.
- Use extreme care if emergency repairs must be made at sea or in adverse conditions.
- The combustible material of some components of the engine (for example certain seals) can become extremely dangerous if it is burned. Never allow this burnt material to come into contact with the skin or with the eyes.
- Read and use the instructions relevant to asbestos joints.
- Fit only genuine Perkins parts.

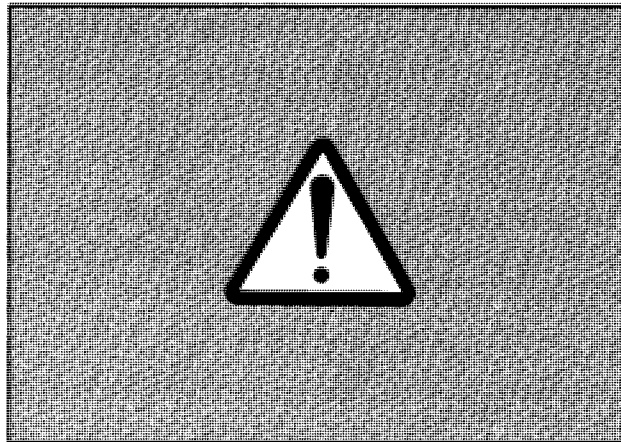

Asbestos joints

- | These engines do not contain asbestos joints and gaskets.
- | These instructions may apply to certain joints and gaskets in components which have been fitted to the engine after it has left the factory.

Some joints and gaskets contain compressed asbestos fibres in a rubber compound or in a metal outer cover. The "white" asbestos (Chrysotile) which is used is a safer type of asbestos and the risk of damage to health is extremely small.

The risk of asbestos from joints occurs at their edges or if a joint is damaged when a component is removed or if a joint is removed by abrasion.

To ensure that the risk is kept to a minimum, the procedures given below must be applied when an engine which has asbestos joints is dismantled or assembled.

- Work in an area with good ventilation
- Do not smoke
- Use a hand scraper to remove the joints - do not use a rotary wire brush
- Ensure that the joint to be removed is wet with oil or water to contain loose particles
- Spray all asbestos debris with water and put it in a closed container which can be sealed for safe disposal

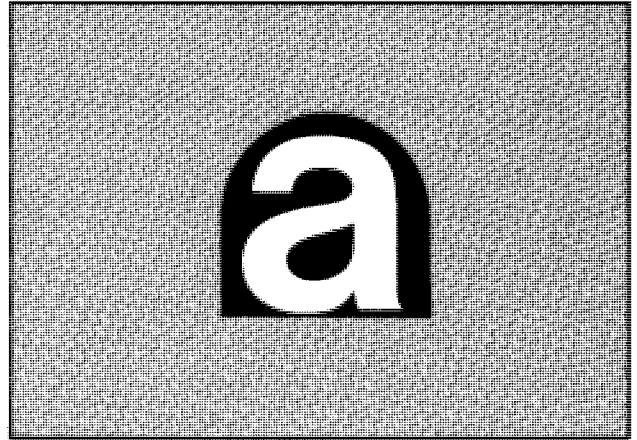

Specifications

11

Basic engine data	11A
Recommended torque tensions	11B
Data and dimensions	11C

Basic engine data

11A

Basic engine data 11A.02

Recommended torque tensions

The torque tensions below apply to components lubricated lightly with clean engine oil before they are fitted.

Description	Thread size	Torque		
		Nm	lbf ft	kgf m
Cylinder head assembly				
Setscrews, cylinder head	M12	See section 12		
Setscrews, camshaft cover	M8	22	16	2,2
Piston and connecting rod assemblies				
Nuts, connecting rod big ends	11/32 UNF	47	35	4,8
Banjo bolts, piston cooling jets	M8	11	8	1,1
Crankshaft assembly				
Setscrews, main bearings	M12	112	83	11,4
Setscrew (gold colour), crankshaft pulleys	M14	180	133	18,4
Setscrew (black colour), crankshaft pulleys	M14	200	148	20,4
Cap screws, crankshaft pulley	M6	12	9	1,2
	M8	27	20	2,7
Setscrews, rear oil seal housing	M8	22	16	2,2
	M10	43	32	4,4
Timing case and drive assembly				
Setscrews, timing case	M5	3	2	0,3
	M6	6	4	0,6
	M8	10	7	1,0
Setscrew, hub of camshaft pulley	M12	85	63	8,7
Setscrew, camshaft pulley to hub	M8	22	16	2,2
Cap screw, tensioner pulley	M10	43	32	4,4
Setscrew, idler pulley	M10	43	32	4,4
Aspiration system				
Nuts, turbocharger to manifold	M8	22	16	2,2
Nuts, exhaust outlet to turbocharger or to heat exchanger	M8	22	16	2,2
Setscrews, inlet and exhaust manifolds	M8	22	16	2,2
Lubrication system				
Plug, lubricating oil sump	1/4 BSP	43	32	4,4
Setscrews, lubricating oil pump	M6	9	7	0,9
	M10	43	32	4,4
Screws, backplate to oil pump	M4	4	3	0,4
Setscrews, filter head to oil pump	M8	22	16	2,2
Setscrews, lubricating oil sump	M6	12	9	1,2
Fuel system				
Nuts, high-pressure fuel pipes	M12	18	13	1,8
Setscrews, atomiser clamps	M10	43	32	4,4
Setscrews, fuel lift pump	M8	22	16	2,2
Setscrews, mounting bracket for fuel injection pump	M10	43	32	4,4
Nut, pulley to fuel injection pump	M14	60	44	6,1
Nuts for flange of fuel injection pump	M8	22	16	2,2

Description	Thread size	Torque		
		Nm	lbf ft	kgf m
Cooling system				
Setscrews, water pump	M8	22	16	2,2
- with engine mounting	M10	48	35	4,9
- without engine mounting	M10	43	32	4,4
Setscrews, raw water pump (marine only)	M6	9	7	0,9
Cap screws, drive adaptor for raw water pump	M6	9	7	0,9
Setscrews, fan and fan extension	M6	9	7	0,9
Cap screw, mounting plate to cylinder head (high level fan drive)	M8	39	29	4,0
Setscrews, fan drive mounting (high level fan)	M8	22	16	2,2
	M10	43	32	4,4
Setscrew, tensioner pulley for fan belt	M10	43	32	4,4
Flywheel and housing				
Setscrews, flywheel to crankshaft	7/16 UNF	65	48	6,6
Setscrews, flywheel housing	M8	22	16	2,2
	M10	43	32	4,4
	M12	81	60	8,3
Electrical equipment				
Nut, alternator pulley	M17	60	44	6,1
Glow plug	M12	20	15	2,0
Auxiliary equipment				
Setscrew, exhauster	M8	22	16	2,2

Data and dimensions

11C

Introduction	11C.02
Cylinder head assembly	11C.02
Piston and connecting rod assemblies	11C.04
Crankshaft assembly	11C.06
Timing case and drive assembly	11C.07
Cylinder block assembly	11C.07
Aspiration system	11C.08
Lubrication system	11C.08
Fuel system	11C.09
Cooling system	11C.10
Flywheel and housing	11C.10
Electrical equipment	11C.11
Auxiliary equipment	11C.11

Introduction

This information is given as a guide for personnel engaged on engine overhauls. The dimensions which are shown are those which are mainly used in the factory. The information applies to all engines, unless an engine type is shown.

Cylinder head assembly

Cylinder head

Angle of valve seats	45°
Diameter of bores for camshaft	48,018/48,057 mm (1.890/1.892 in)
Diameter of parent bores for valve guides	11,98/12,00 mm (0.4716/0.4724 in)
Diameter of bores for tappets	31,750/31,775 mm (1.250/1.251 in)
Leak test pressure	200 kPa (29 lbf/in ²) 2,04 kgf/cm ²
Maximum permissible distortion of cylinder head	0,10 mm (0.004 in)
Head thickness	120,0/120,1 mm (4.724/4.728 in)
Permissible amount to machine from cylinder head face	0,20 mm (0.008 in) - depth of head must not be less than 119,85 mm (4.718 in)

Valve guides

Inside diameter (reamed in position)	7,450/7,463 mm (0.2933/0.2938 in)
Outside diameter	12,04/12,06 mm (0.474/0.475 in)
Interference fit of valve guide in cylinder head	0,04/0,08 mm (0.0016/0.0031 in)
Protrusion above location face for valve spring	10 mm (0.39 in)

Inlet valves

Diameter of valve stem	7,41/7,42 mm (0.2917/0.2922 in)
Clearance in valve guide	0,03/0,05 mm (0.001/0.002 in)
Maximum permissible clearance in valve guide	0,13 mm (0.005 in)
Diameter of valve head	37,10/37,25 mm (1.461/1.467 in)
Angle of valve face	44° 30' (91° included angle)
Depth of valve head below face of cylinder head	0,90/1,24 mm (0.035/0.049 in)
Overall length	93,72/93,97 mm (3.690/3.700 in)
Seal arrangement	Rubber seal fitted to valve guide

Exhaust valves

Diameter of valve stem	7,39/7,41 mm (0.2909/0.2917 in)
Clearance in valve guide	0,04/0,07 mm (0.0016/0.0028 in)
Maximum permissible clearance in valve guide	0,13 mm (0.005 in)
Diameter of valve head	33,55/33,70 mm (1.321/1.327 in)
Valve face angle	44° 30' (91° included angle)
Depth of valve head below face of cylinder head	1,30/1,64 mm (0.051/0.065 in)
Overall length	93,72/93,97 mm (3.690/3.700 in)
Seal arrangement	Rubber seal fitted to valve guide

Valve springs - vehicle, M60 and M80T engines

Fitted length	...	34,7 mm (1.37 in)
Load at fitted length	...	198 N (44.5 lbf) 20,2 kgf
Number of active coils	...	4.5
Number of damper coils	...	0
Direction of coils	...	Left hand
Identification colour	...	Orange

Valve springs - 500 and M50 engines

Fitted length	...	34,7 mm (1.37 in)
I Load at fitted length	...	142/157 N (32/35 lbf) 14.5/16.0 kgf
Number of active coils	...	5.2
Number of damper coils	...	0
Direction of coils	...	Left hand
Identification colour	...	White

Tappets and shims

Material:

- Vehicle, M60 and M80T engines	...	Steel
- 500 and M50 engines	...	Cast iron

Outside diameter of tappet	...	31,725/31,745 mm (1.2490/1.2498 in)
----------------------------	-----	-------------------------------------

Clearance of tappet in cylinder head	...	0,005/0,050 mm (0.0002/0.0020 in)
--------------------------------------	-----	-----------------------------------

Thickness of tappet head	...	6,85/6,93 mm (0.270/0.273 in)
--------------------------	-----	-------------------------------

Overall length:

- Vehicle, M60 and M80T engines	...	25,7/26,3 mm (1.01/1.04 in)
---------------------------------	-----	-----------------------------

- 500 and M50 engines	...	29,7/30,3 mm (1.17/1.19 in)
-----------------------	-----	-----------------------------

Shim thickness	...	Range of 45 shims from 2,286 mm (0.090 in) to 3,400 mm (0.134 in) in grades of 0,025 mm (0.001 in)
----------------	-----	--

Camshaft

Diameter of front and rear journals	...	47,963/47,975 mm (1.8883/1.8888 in)
-------------------------------------	-----	-------------------------------------

Diameter of centre journal	...	47,958/47,975 mm (1.8881/1.8888 in)
----------------------------	-----	-------------------------------------

Clearance of journals in bores:

- Front and rear	...	0,043/0,094 mm (0.0017/0.0037 in)
------------------	-----	-----------------------------------

- Centre	...	0,043/0,099 mm (0.0017/0.0039 in)
----------	-----	-----------------------------------

Diameter for pulley hub	...	36,58/36,61 mm (1.440/1.441 in)
-------------------------	-----	---------------------------------

Cam lift - vehicle, M60 and M80T engines:

- Inlet and exhaust	...	9,544/9,724 mm (0.3757/0.3828 in)
---------------------	-----	-----------------------------------

Cam lift - 500 and M50 engines:

I - Inlet (camshaft part number L141DF11)...	...	8,844/9,024 mm (0.3482/0.3553 in)
--	-----	-----------------------------------

I - Inlet (camshaft part number L141DF02)...	...	9,044/9,224 mm (0.3561/0.3632 in)
--	-----	-----------------------------------

- Exhaust	...	9,344/9,524 mm (0.3679/0.3750 in)
-----------	-----	-----------------------------------

End-float	...	0,11/0,27 mm (0.004/0.011 in)
-----------	-----	-------------------------------

Maximum permissible end-float in service	...	0,50 mm (0.020 in)
--	-----	--------------------

Width of recess for thrust washer	...	6,06/6,12 mm (0.239/0.241 in)
-----------------------------------	-----	-------------------------------

Camshaft thrust washer

Type	...	180° washer fitted in camshaft cover
------	-----	--------------------------------------

Thickness	...	5,90/5,95 mm 0.232/0.234 in
-----------	-----	-----------------------------

Transition fit of thrust washer in camshaft cover recess	...	± 0,05 mm (± 0.002 in)
--	-----	------------------------

Piston and connecting rod assemblies

Pistons

Type	"Swirl lip" combustion bowl, controlled expansion, insert for top ring groove, off centre gudgeon pin
Diameter of bore for gudgeon pin	28,004/28,010 mm (1.1025/1.1028 in)
Difference between height grades:		
- Production grades 1 to 6	0,05 mm (0.002 in)
- Service grades 3 and 6	0,15 mm (0.006 in)
Height of piston above top face of cylinder block:		
- Naturally aspirated vehicle, and M60 engines	0,46/0,65 mm (0.018/0.026 in)
- Turbocharged vehicle and M80T engines	0,41/0,60 mm (0.016/0.024 in)
- 500 and M50 engines	0,52/0,71 mm (0.020/0.028 in)
Width of groove for top ring	2,10/2,12 mm (0.0827/0.0835 in)
Width of groove for second ring	1,81/1,83 mm (0.071/0.072 in)
Width of groove for third ring	3,03/3,05 mm (0.119/0.120 in)
Oversize piston	0,50 mm (0.020 in) on diameter

Piston rings

Top compression ring	Barrel face, molybdenum insert, internal chamfer in top face
Second compression ring	Taper face, cast iron
Oil scraper ring	Coil spring loaded, chromium faced
Width of top ring	1,978/1,990 mm (0.0778/0.0783 in)
Width of second ring	1,73/1,74 mm (0.068/0.069 in)
Width of third ring	2,98/2,99 mm (1.117/0.118 in)
Clearance of top ring in groove	0,11/0,14 mm (0.004/0.006 in)
Clearance of second ring in groove	0,07/0,10 mm (0.003/0.004 in)
Clearance of third ring in groove	0,04/0,07 mm (0.002/0.003 in)
Gap of top ring	0,28/0,56 mm (0.011/0.022 in)
Gap of second ring	0,28/0,56 mm (0.011/0.022 in)
Gap of third ring	0,23/0,56 mm (0.009/0.022 in)

Connecting rods

Type	"H" section
Diameter of parent bore for big end	57,683/57,696 mm (2.2710/2.2715 in)
Diameter of parent bore for small end	30,93/30,96 mm (1.218/1.219 in)
Length between centres	144,98/145,03 mm (5.708/5.710 in)

Connecting rod alignment (A)

The large and small end bores must be square and parallel with each other within the limits of $\pm 0,25\text{mm}$ (0.010in) measured 127 mm (5.0 in) each side of the connecting rod axis on a test mandrel. With the small end bush fitted, the limits are reduced to $\pm 0,06\text{ mm}$ (0.0025 in).

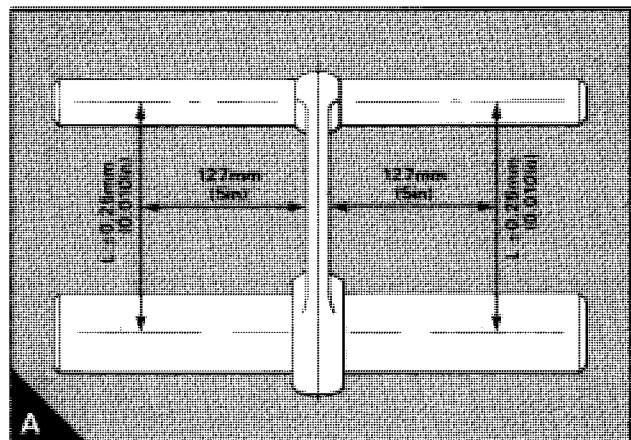

Gudgeon pins

Type	Fully floating
Outside diameter	27,995/28,000 mm (1.1022/1.1024 in)
Clearance fit in piston boss	0,004/0,015 mm (0.0002/0.0006 in)

Small end bushes

Type	Steel back, lead bronze bearing material
Inside diameter (reamed)	28,005/28,018 mm (1.1026/1.1031 in)
Clearance between small end bush and gudgeon pin	0,005/0,023 mm (0.0002/0.0009 in)

Connecting rod bearings

Type	Steel back, copper lead bearing material
Thickness	1,815/1,825 mm (0.0715/0.0719 in)
Inside diameter	54,033/54,066 mm (2.1273/2.1286 in)
Bearing clearance	0,023/0,076 mm (0.001/0.003 in)
Available undersize bearings	-0,30 mm (-0.012 in)

Crankshaft assembly

Crankshaft

Diameter of main journals	56,99/57,01 mm (2.2437/2.2445 in)
Maximum permissible wear and ovality of main journals	0,03 mm (0.001 in)
Width of front journal	27,9/28,6 mm (1.10/1.13 in)
Width of centre journal	32,35/32,43 mm (1.724/1.727 in)
Width of all other journals	30,5/31,1 mm (1.20/1.22 in)
Diameter of crank pins	53,99/54,01 mm (2.1256/2.1264 in)
Maximum permissible wear and ovality of crank pins	0,03 mm (0.001 in)
Width of crank pins	27,45/27,65 mm (1.081/1.089 in)
Crankshaft end-float	0,03/0,26 mm (0.001/0.010 in)
Diameter of rear flange	88,84/88,95 mm (3.498/3.502 in)
Minimum permissible diameter of rear flange (service)	88,59 mm (3.488 in)
Diameter for front oil seal	34,965/34,995 mm (1.3766/1.3778 in)
Minimum permissible diameter for front oil seal (service)	34,72 mm (1.367 in)
Diameter for toothed pulley	31,98/32,00 mm (1.259/1.260 in)
Diameter of recess for spigot bearing	28,58/28,60 mm (1.125/1.126 in)
Depth of recess for spigot bearing	20,8 mm (0.82 in)
Undersize journals and crank pins	-0,30 mm (-0.012 in)

Main bearings

Type	Steel back, aluminium tin bearing material
Bearing width, centre bearing	24,27/24,52 mm (0.956/0.965 in)
Bearing width, all other bearings	22,35/22,60 mm (0.880/0.890 in)
Bearing thickness	1,828/1,835 mm (0.0720/0.0722 in)
Inside diameter	57,033/57,063 mm (2.2454/2.2466 in)
Bearing clearance	0,023/0,073 mm (0.001/0.003 in)
Available undersize bearings	-0,30 mm (-0.012 in)

Crankshaft thrust washers

Type	Steel back, aluminium tin bearing material
Position	Each side of centre main bearing
Thickness	2,31/2,36 mm (0.091/0.093 in)

Timing case and drive assembly

Toothed pulley for crankshaft

Number of teeth	24
Diameter of bore	32,010/32,035 mm (1.2602/1.2612 in)
Clearance fit of pulley on crankshaft	0,010/0,055 mm (0.0004/0.0022 in)

Toothed pulley and hub for camshaft

Number of teeth	48
Diameter of bore in hub	36,62/36,65 mm (1.442/1.443 in)
Clearance fit of hub on camshaft	0,01/0,07 mm (0.0004/0.0028 in)

Toothed pulley for fuel injection pump

Number of teeth	48
Bore	Tapered

Timing tooth and keyway letter:

I Where plunger lift of fuel injection pump at engine TDC is 1.26 mm (0.050 in) and above	"A"
I Where plunger lift of fuel injection pump at engine TDC is below 1.26 mm (0.050 in)	"B"

Idler pulley for timing belt

Outside diameter	79,8/80,2 mm (3.14/3.16 in)
Radial internal clearance	0,005/0,025 mm (0.0002/0.0010 in)

Tensioner pulley for timing belt

Outside diameter	59,8/60,2 mm (2.35/2.37 in)
Radial internal clearance	0,005/0,025 mm (0.0002/0.0010 in)

Timing belt tension (gauge):

- New belt	95/105 lbf
- Used belt	80 lbf

Cylinder block assembly

Cylinder block

Height between top face and location face for bearing cap	236,85/236,98 mm (9.325/9.330 in)
Cylinder bore diameter	84,442/84,469 mm (3.3245/3.3256 in)
Maximum permissible wear in bore	0,15 mm (0.006 in)
Oversize cylinder bore diameter	84,942/84,969 mm (3.3442/3.3452 in)
Diameter of parent bore for main bearing	60,703/60,719 mm (2.3899/2.3905 in)

Aspiration system

Turbocharger

Make and type of turbocharger	Airesearch T2
Boost pressure	89/96 kPa (12.9/13.9 lbf/in ²) 0,91/0,98 kgf/cm ²

Lubrication system

Lubricating oil pump

Type	Differential rotor, fitted around nose of crankshaft
Number of lobes	Inner rotor 10, outer rotor 11
Outer rotor to body clearance	0,30/0,36 mm (0.012/0.014 in)
Inner rotor to outer rotor clearance	0,025/0,082 mm (0.001/0.003 in)
Inner rotor end clearance	0,030/0,075 mm (0.001/0.003 in)
Outer rotor end clearance	0,05/0,10 mm (0.002/0.004 in)

Oil pressure relief valve

Valve open pressure	414 kPa (60 lbf/in ²) 4,2 kgf/cm ²
Bore diameter of sleeve	14,21/14,25 mm (0.5594/0.5610 in)
Outside diameter of plunger	14,160/14,186 mm (0.5575/0.5585 in)
Clearance of plunger in sleeve	0,024/0,090 mm (0.0009/0.0035 in)
Length of spring (fitted)	30,4 mm (1.2 in)
Load on spring (fitted)	51,1 N (11.5 lbf) 5,2 kgf

Fuel system

Fuel injection pump

- Make Bosch
- Type EPVE
- Direction of rotation (from drive end) Clockwise
- Outlet for number 1 cylinder "A"
- Plunger lift at engine TDC:
 - I - Naturally aspirated vehicle engines
 - with standard atomisers 1,37 mm (0.054 in)
 - with two-stage atomisers 1,00 mm (0.039 in)
 - Turbocharged vehicle engines
 - with standard atomisers 1,00 mm (0.039 in)
 - with two-stage atomisers 1,20 mm (0.047 in)
 - I - Naturally aspirated industrial engines 1,42 mm (0.056 in)
 - I - Turbocharged industrial engines
 - all build lists except BB50325 1,24 mm (0.049 in)
 - build list BB50325 1,42 mm (0.056 in)
 - I - M50 marine engines 1,42 mm (0.056 in)
 - I - M60 marine engines 1,37 mm (0.054 in)
 - I - M80T marine engines 1,17 mm (0.046 in)

Atomisers

Code	Holder	Nozzle	Set and reset pressure			
			atm	lbf/in ²	MPa	
JC	LRB67030	JB6801061	225	3310	22,8	
JD	LRB67030	JB6801062	225	3310	22,8	
RG	KBEL68P40	DLLA150P159	225	3310	22,8	
I I	JP RL	Two stage atomiser - first stage (check pressure only)		180 200	2650 2975	18,2 20,5

Fuel lift pump

- Type A.C.Delco, type YD
- Method of drive Eccentric on camshaft
- Static pressure (no delivery) 41/69kPa (6/10lbf/in²) 0,4/0,7 kgf/cm²

Fuel filter

- Make Bosch
- Type Screw type canister

Cooling system

Water pump

Type Centrifugal, belt driven

Raw water pump - marine engines only

Make Jabsco

Type Rubber impeller

Drive From rear end of camshaft

Thermostat - vehicle engines

Type Wax pellet, by-pass blanking

“Start to open” temperature 85°/89°C (185°/192°F)

“Fully open” temperature 99°/102°C (210°/216°F)

Valve lift, fully open 9,5 mm (0.374 in) minimum

Thermostat - 500 and marine engines

Type Wax pellet, by-pass blanking

“Start to open” temperature 77°/85°C (171°/185°F)

“Fully open” temperature 92°/98°C (198°/208°F)

Valve lift, fully open 9,1 mm (0.358 in) minimum

Flywheel and housing

Flywheel

Maximum permissible run-out 0,30 mm (0.012 in) total indicator reading

Maximum alignment error 0,03 mm (0.001 in) total indicator reading for every 25 mm (1.0 in) of flywheel radius from crankshaft axis to indicator plunger

Flywheel housing

Limits for concentricity and alignment 0,15 mm (0.006 in) total indicator reading

Electrical equipment**Alternator**

Manufacturer	Lucas
Type	A127-55 or A127-70MT
Rating:		
-A127-55	12V/55A
-A127-70MT	12V/70A
Rotation	Clockwise, from drive end

Starter motor

Manufacturer	Lucas
I Type	M80R or 2M113
Voltage	12V
Number of teeth on pinion	10
Maximum resistance of starter cable at 20°C (68°F)	0.0017 ohms
I Brush length:		
		M80R 2M113
I - New	9,0 mm (0.35 in) 22 mm (0.87 in)
I - Minimum permissible, worn	3,5 mm (0.14 in) 8 mm (0,32 in)

Glow plugs

I Manufacturer	Bosch or BERU
I Current:		
I - Bosch with 23 mm (0.90 in) probe...	12A after 20 seconds
I - Bosch with 28 mm (1.10 in) probe...	11A after 20 seconds
I - BERU with 24 mm (0.95 in) probe...	16A after 4 seconds

Auxiliary equipment**Exhauster**

Make and type	Clayton Dewandre REGA 1560, 70 ml piston
Drive	Eccentric on camshaft



Cylinder head assembly

12

	General description	12A.02
	Camshaft cover	
12A-01	To remove and to fit	12A.03
	Tappet clearances	
12A-02	To check	12A.04
12A-03	To adjust	12A.04
	Front oil seal of camshaft	
12A-04	To remove and to fit	12A.06
	Rear oil seal of camshaft	
12A-05	To remove and to fit	12A.06
	Camshaft	
12A-06	To remove and to fit	12A.07
	Cylinder head assembly	
12A-07	To remove and to fit	12A.08
	Valves and valve springs	
12A-08	To remove and to fit	12A.10
12A-09	To inspect and to correct	12A.10
	Valve guides	
12A-10	To inspect	12A.11
12A-11	To remove and to fit	12A.11
	Cylinder head	
12A-12	To inspect and to correct	12A.12
12A-13	To correct a valve seat with a valve seat cutter	12A.13
12A-14	To fit valve seat inserts	12A.13

General description

In a diesel engine there is little carbon deposit and for this reason the number of hours run is no indication of when to overhaul a cylinder head assembly. The factors which indicate when an overhaul is necessary are how easily the engine starts and its general performance.

The cylinder head is made of aluminium and the head and the camshaft cover are bored together to provide bearing locations for the camshaft. The cams of the camshaft are directly above the valves and operate them through tappets which are fitted on top of the valves. Shims are fitted between the tappets and the tops of the valves to allow for adjustment of tappet clearances.

The cylinder head assembly has two valves fitted for each cylinder. Each valve is fitted with a single valve spring.

The valves move in cast iron guides which are a press fit in the cylinder head and can be renewed.

Both valve stems are fitted with oil seals which fit over the top of the valve guides.

Valve seat inserts are fitted in the cylinder head for both inlet and exhaust valves.

Camshaft cover

To remove and to fit

12A-01

To remove

1 Remove the setscrew which fastens the front flange of the camshaft cover to the timing case (A1).

Some vehicle engines have a setscrew, fitted inside the timing case, which also fastens the timing case to the camshaft cover (A2). For these engines the timing case cover will have to be removed and the setscrew released.

Marine engines: Remove the setscrew which is fitted through the drive housing of the raw water pump into the rear flange of the cover (A3). If the cover is too tight for removal, loosen the mounting bracket for the raw water pump.

2 Remove the setscrew from the timing hole in the top front of the camshaft cover (A4). Turn the crankshaft until the timing hole in the front journal of the camshaft aligns with the hole in the cover. This will ensure easier removal of the fuel lift pump and the camshaft cover.

3 Remove the engine lift brackets, if fitted. If nothing is driven from the rear of the camshaft, remove the rear cover and fit the camshaft retainer PD.181 (B1). This will ensure that the camshaft will not tilt when the camshaft cover is removed.

4 Remove the fuel lift pump, operation 20A-03 and the exhauster, operation 24A-01, if fitted.

5 Loosen evenly the setscrews of the camshaft cover in the reverse sequence to that given in figure D. Remove the setscrews and the cover (B). Ensure that the thrust washer (B2) remains in position in the cover.

To fit

1 Check the cover and the thrust washer for the camshaft for wear and for other damage. If the cover is worn or damaged, a new cylinder head assembly will be needed as the bores for the camshaft journals are machined with the cover and the head fastened together.

2 Check that the location thimbles (B3) and the thrust washer (B2) are correctly fitted. Ensure that the front and the rear seals of the camshaft are still in their correct positions against the shoulders in the cylinder head and that they are not tilted.

3 Ensure that the grooves in the camshaft cover and the contact faces of the cylinder head and the cover are clean. Apply a 2 mm (0.08 in) diameter bead of POWERPART Hylosil to the outer grooves of the cover but leave the inner grooves empty, as shown in figure (C). As soon as the sealant has been applied, fit the cover. Fit the cover setscrews with the longer setscrews at each end of the cover. Gradually tighten the setscrews to keep the cover parallel to the cylinder head as it is pulled down. Finally tighten the cover setscrews to 22 Nm (16 lbf ft) 2,2 kgf m in the sequence shown in figure (D).

4 Where necessary, remove the camshaft retainer and fit the rear end cover.

Marine engines: Fit and tighten the setscrew which fastens the drive housing of the raw water pump to the camshaft cover. If the mounting bracket for the raw water pump has been loosened, align the bracket before it is fastened, see operation 21A-08.

5 Fit and tighten the setscrew(s) which fasten(s) the timing case to the camshaft cover. If necessary, fit the timing case cover.

6 Ensure that the timing hole in the front journal of the camshaft aligns with the timing hole in the camshaft cover. Fit the fuel lift pump, operation 20A-03 and if necessary, the exhauster, operation 24A-01. Fit the setscrew in the timing hole in the camshaft cover. If necessary, fit the engine lift brackets.

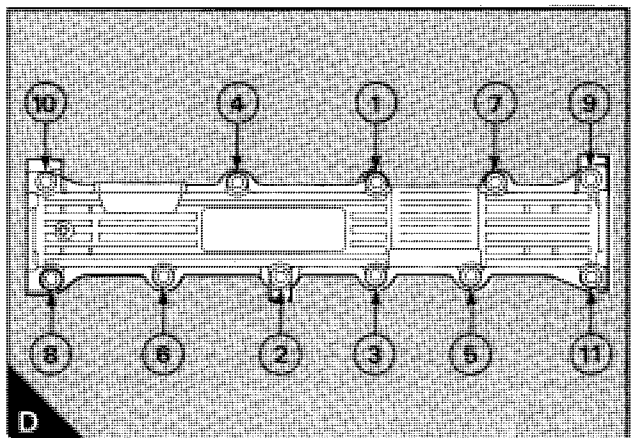
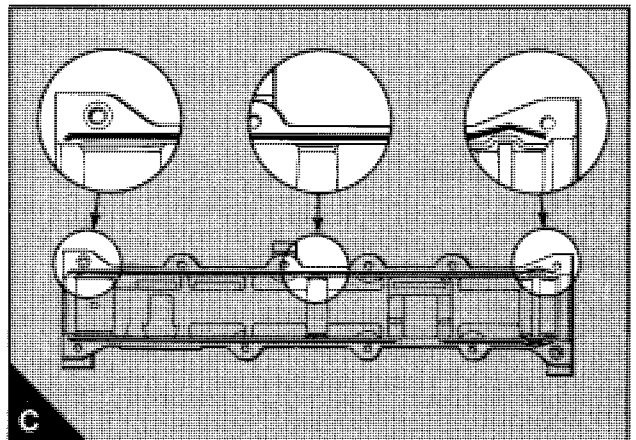
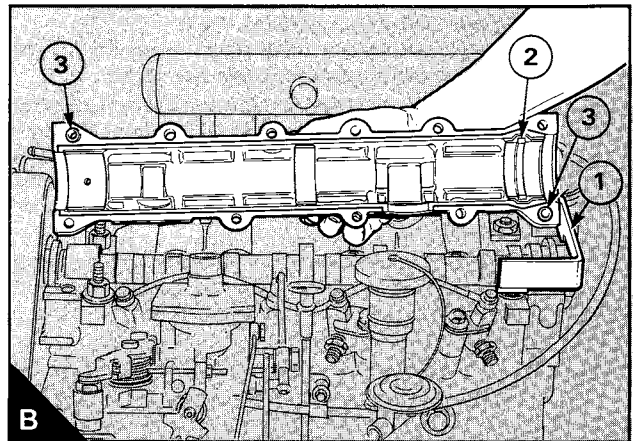
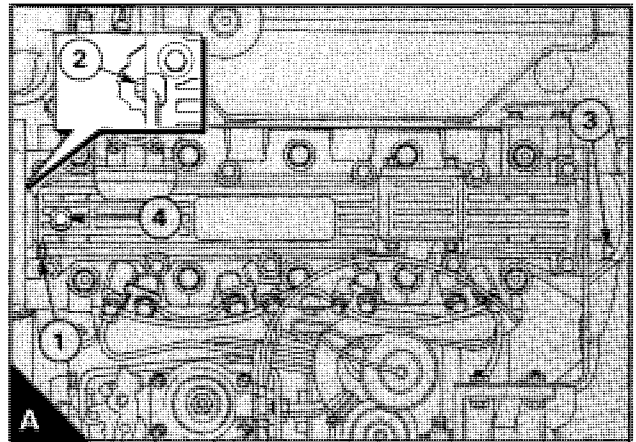

Tappet clearances

To check

12A-02

Special tools:

Camshaft retainer, PD.181

Camshaft clamps, PD.180

The tappet clearances are measured between the camshaft and the top of the tappets (A). With the engine cold, the correct clearances are 0,25/0,35 mm (0.010/0.014 in) for the inlet valves and 0,35/0,45 mm (0.014/0.018 in) for the exhaust valves. See B for the position of the inlet and exhaust cams.

Number 1 cam is at the pulley end of the camshaft.

Attention: If the cylinder head is not fitted to the engine, see 16, operation 12A-12.

- 1 Disconnect the battery.
- 2 Remove the camshaft cover, operation 12A-01.
Marine engines: Remove the raw water pump, operation 21A-06 and fit the camshaft retainer before the cover is removed.
- 3 Fit the camshaft clamps PD.180 (A1) to retain the camshaft and fit the relevant cover setscrews to the clamps. It will be necessary to move the rear seal on the camshaft to ensure that there is clearance between the rear clamp and the seal. Ensure that the spring loaded pads are correctly fitted on the camshaft journals and tighten evenly the clamp setscrews.
- 4 Turn the crankshaft until the lobes of numbers 1 and 3 cams are both near to their top position. Use feeler gauges with bent blades to measure the tappet clearances of numbers 1 and 3 valves. Make a note of the clearances.
- 5 Repeat 4 for valves 2 and 5, 6 and 8, and 4 and 7.
- 6 Adjustment is only necessary if the clearances are outside the limits of 0,20/0,40 mm (0.008/0.016 in) for inlet valves or 0,30/0,50 mm (0.012/0.020 in) for exhaust valves. If adjustment is necessary, see operation 12A-03.
- 7 When the clearances are correct, remove the camshaft journal clamps and fit the camshaft cover, operation 12A-01.
- 8 Connect the battery.

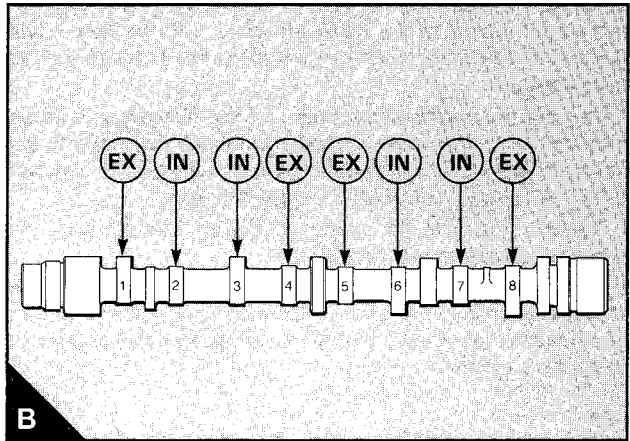
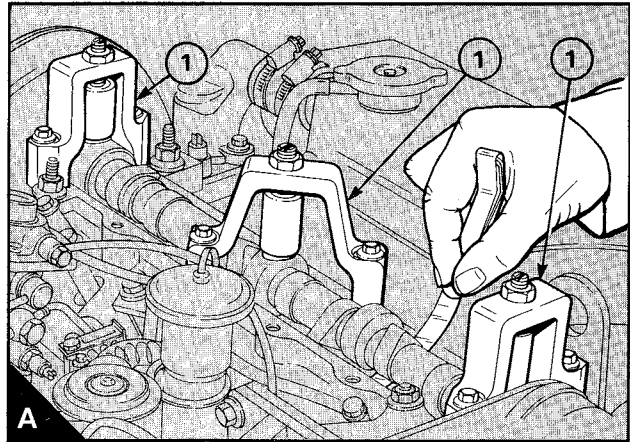

To adjust

12A-03

Special tools:

Camshaft clamps, PD.180

Camshaft retainer, PD.181

Timing pins for camshaft and crankshaft, PD.182

Location pins for the pulley of the fuel injection pump, PD.190

Anti-rotation tool, PD.203

If it is found during a check of the tappet clearances, operation 12A-02, that adjustment is necessary, proceed as follows:

Attention: If the cylinder head is not fitted to the engine, see 16, operation 12A-12.

- 1 Turn the crankshaft until the timing hole in the front journal of the camshaft is in the 12 o'clock position. Fit the timing pin PD.182 through the backplate or through the flywheel housing into the timing hole in the flywheel. Remove the starter motor, operation 23B-01 and fit the anti-rotation tool PD.203 to the flywheel.
- 2 Remove the timing case cover, operation 15A-01.
- 3 Loosen the setscrews of the camshaft pulley and the setscrew of the pulley hub.
- 4 Fit the location pins PD.190 to hold the pulley of the fuel injection pump.
- 5 Remove the timing belt, the camshaft pulley and the pulley hub, see section 15.
- 6 Remove the camshaft retainer or, for marine engines, remove the raw water pump, operation 21A-06 and the pump mounting bracket, operation 21A-08.

7 Remove the camshaft clamps and remove the camshaft (12A.07/A). Remove the seals from the camshaft.

8 Adjust at each tappet in sequence: Remove the tappet (A1) and remove the shim (A2) which is fitted in the top of the valve spring cap (A3). From the notes obtained in operation 12A-02, find the amount of adjustment needed for this tappet. Measure the thickness of the shim. If the clearance needs to be increased, put in a shim which is thinner by the necessary amount. If the clearance needs to be decreased, put in a thicker shim. For calculation purposes, use the average clearances of 0,30 mm (0.012 in) for inlet valves and 0,40 mm (0.016 in) for exhaust valves. Lubricate the tappet and fit it into its bore. Repeat the operation for each tappet which needs adjustment.

9 When all the necessary shims have been changed, put the camshaft in position and temporarily fit the hub for the camshaft pulley. Remove the timing pin and the anti-rotation tool from the flywheel. Turn the crankshaft a quarter of a turn in a clockwise direction. Fit the camshaft clamps PD.180 and check that the tappet clearances are correct, operation 12A-02.

10 When the clearances are correct, remove the hub for the camshaft pulley and the camshaft clamps. Turn the crankshaft a quarter of a turn in a counter-clockwise direction. Fit the timing pin and the anti-rotation tool to the flywheel. Lubricate the tappets and the journals and cams of the camshaft.

11 Fit the camshaft cover, operation 12A-01.

12 Fit new front and rear seals to the camshaft, operations 12A-04 and 12A-05.

13 Fit the camshaft pulley and the timing belt, see section 15. Remove the location pins from the pulley of the fuel injection pump and adjust the belt tension, operation 15A-03.

14 Remove the flywheel timing pin and the anti-rotation tool. Check the timing of the fuel injection pump, operation 17A-03.

15 Fit the timing case cover, operation 15A-01.

16 Fit the setscrew in the timing hole of the camshaft cover. Fit the rear plate of the camshaft cover.

Marine engines: Fit the bracket for the raw water pump, operation 21A-08 and the raw water pump, operation 21A-06.

17 Turn the crankshaft through two revolutions to ensure that there is no restriction to movement.

18 Fit the starter motor, operation 23B-01 and connect the battery.

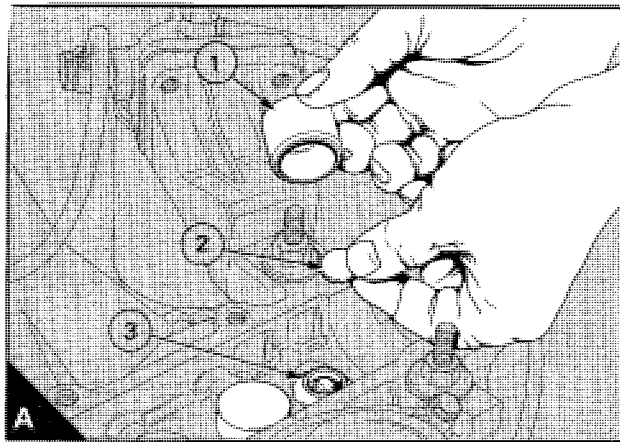

Front oil seal of camshaft

To remove and to fit

12A-04

Special tools:

Remover for front seal of camshaft, PD.185

Replacer for front seal of camshaft, PD.186

Timing pins for camshaft and crankshaft, PD.182

Location pins for the pulley of the fuel injection pump, PD.190

Anti-rotation tool, PD.203

- 1 Disconnect the battery.
- 2 Remove the setscrew from the timing hole in the top front of the camshaft cover (12A.03/A4). Turn the crankshaft until the timing hole in the front journal of the camshaft aligns with the hole in the cover.
- 3 Fit the timing pins PD.182 to the camshaft and to the flywheel. Remove the starter motor, operation 23B-01 and fit the anti-rotation tool PD.203 to the flywheel.
- 4 Remove the timing case cover, operation 15A-01.
- 5 Remove the camshaft pulley, operation 15A-06.
- 6 Fit the plug of tool PD.185 (A1) into the front end of the camshaft. Release the centre screw (A2) enough to ensure that it will not reach the plug and enter the main tool into the seal. Turn the tool clockwise to ensure that it is tight in the seal and tighten the centre screw onto the plug to remove the seal.
- 7 Ensure that the seal housing and the camshaft are clean and that they are not damaged. Lubricate the new seal with clean engine lubricating oil and enter it into position with the seal lip to the inside. Use the seal replacer PD.186 (B1) with a soft face hammer to fit the seal into its final position.
- 8 Fit the camshaft pulley and the timing belt, see section 15. Remove the location pins from the pulley of the fuel injection pump and adjust the tension of the timing belt, operation 15A-03.
- 9 Remove the anti-rotation tool.
- 10 Check the timing of the fuel injection pump, operation 17A-03.
- 11 Remove the timing pins and turn the crankshaft through two revolutions to ensure that there is no restriction to movement.
- 12 Fit the setscrew in the timing hole in the camshaft cover. Fit the starter motor, operation 23B-01 and connect the battery.

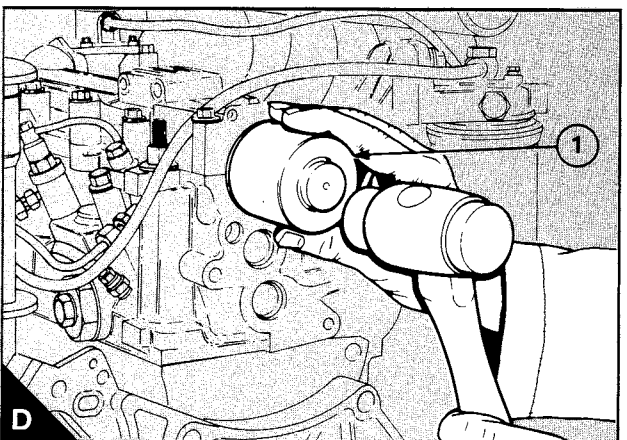
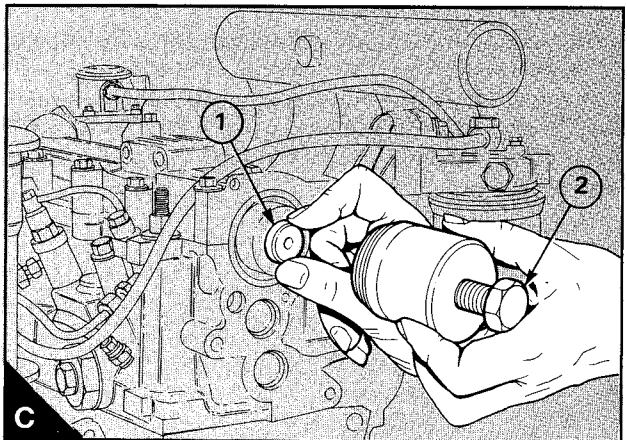
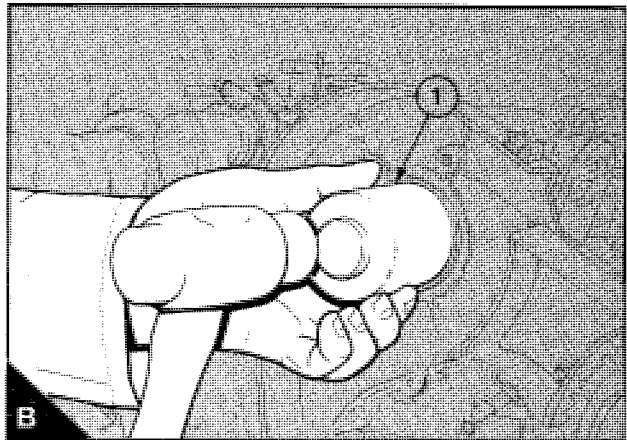
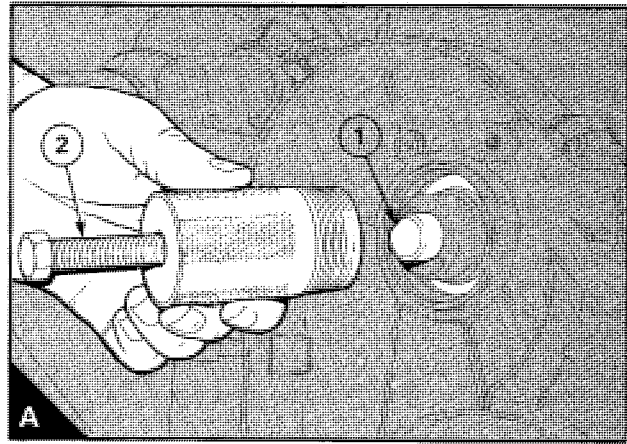

Rear oil seal of camshaft

To remove and to fit

12A-05

Special tools:

Remover for rear seal of camshaft, PD.187

Replacer for rear seal of camshaft, PD.188

Alignment adaptor for drive housing of raw water pump (marine engines only), PD.207

- 1 Remove the rear cover of the camshaft.
Marine engines: Remove the raw water pump and its drive housing and remove the drive adaptor from the end of the camshaft, see section 21.
- 2 Fit the plug of tool PD.187 (C1) into the rear of the camshaft.
- 3 Release the centre screw (C2) enough to ensure that it will not reach the plug and enter the main tool into the seal. Turn the tool clockwise to ensure that it is tight in the seal and tighten the centre screw onto the plug to remove the seal.
- 4 Ensure that the seal housing and the camshaft are clean and that they are not damaged. Lubricate the new seal with clean engine lubricating oil and enter it into position with the seal lip to the inside. Use the seal replacer PD.188 (D1) with a soft face hammer to fit the seal into its final position.

5 Fit the rear cover of the camshaft.

Marine engines: Fit the drive housing of the raw water pump with the bore correctly aligned, operation 21A-08. Fit the drive adaptor for the raw water pump and tighten the cap screws to 9 Nm (7 lbf ft) 0,9 kgf m. Fit the raw water pump, operation 21A-06.

Camshaft

To remove and to fit

12A-06

- 1 Disconnect the battery.
 - 2 Remove the setscrew from the timing hole in the top front of the camshaft cover (12A.03/A4). Turn the crankshaft until the timing hole in the front journal of the camshaft aligns with the hole in the cover.
 - 3 Fit the timing pins PD.182 to the camshaft and to the flywheel. Remove the starter motor, operation 23B-01 and fit the anti-rotation tool PD.203 to the flywheel.
 - 4 Remove the timing case cover, operation 15A-01.
 - 5 Remove the camshaft pulley, operation 15A-06.
 - 6 Remove the camshaft cover, operation 12A-01.
- Marine engines: Remove the raw water pump and its drive housing and bracket and, if necessary, the drive adaptor from the end of the camshaft, see section 21.
- 7 Remove the camshaft (A) and remove the camshaft seals.
 - 8 Check the camshaft for wear and for damage and renew it, if necessary.
 - 9 If necessary, fit the drive adaptor for the raw water pump (marine engines only).
 - 10 Ensure that the camshaft is clean and lubricated with clean engine oil. Put the camshaft in position and, if necessary, check the tappet clearances, see operation 12A-02.
 - 11 Fit the camshaft cover, operation 12A-01.
 - 12 Check the end-float of the camshaft with a dial test indicator (B). The limits are given in section 11C.
 - 13 Fit the camshaft seals, operations 12A-04 and 12A-05.
 - 14 Fit the rear cover of the camshaft.
- Marine engines: Fit the drive bracket and the housing for the raw water pump and fit the pump, section 21.
- 15 Fit the camshaft pulley and the timing belt and adjust the belt tension, section 15.
 - 16 Check the timing of the fuel injection pump, operation 17A-03.
 - 17 Fit the timing case cover, operation 15A-01. Fit the setscrew in the timing hole in the top front of the camshaft cover.
 - 18 **Ensure that all the timing pins and the anti-rotation tool are removed.** Turn the crankshaft through two revolutions to ensure that there is no restriction to movement.
 - 19 Fit the starter motor operation 23B-01 and connect the battery.

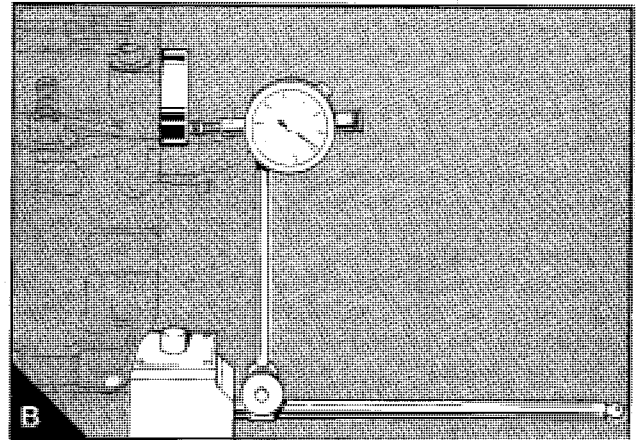
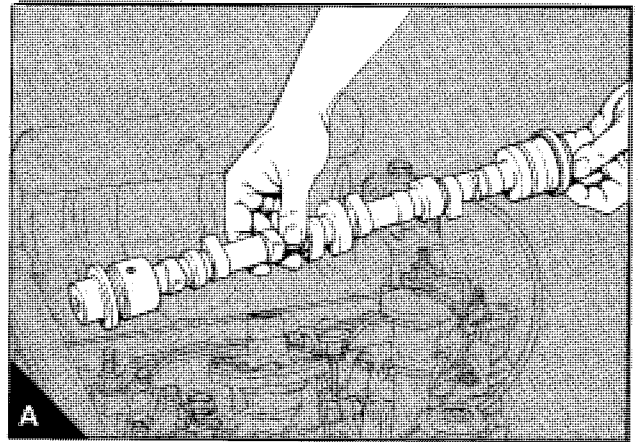

Cylinder head assembly

To remove and to fit

12A-07

To remove

- 1 Disconnect the battery.
- 2 Drain the cooling system.

Marine engines: See operations 21A-01 and 21A.03.

3 Disconnect the coolant hose from the thermostat housing. If necessary, disconnect the by-pass hose at the bottom of the thermostat housing. If necessary, disconnect the heater hoses.

4 Disconnect all electrical connections at the cylinder head and the thermostat housing.

5 Disconnect the air inlet pipe and the exhaust pipe.

6 If the cylinder head is to be dismantled, remove the inlet and the exhaust manifolds.

Marine engines: Remove the inlet manifold, the turbocharger (if fitted) and the heat exchanger/manifold/header tank assembly, operation 21A-12.

7 Disconnect the fuel lift pump and the exhauster, if fitted.

8 Disconnect the fuel filter and remove it from its bracket.

9 Remove the high-pressure pipes from the atomisers and from the fuel injection pump - do not bend the pipes. When a pipe nut is loosened at the pump, hold the outlet connection of the pump with a spanner to prevent movement of the connection. Fit covers to the open connections of the atomisers and of the pump.

10 Remove the atomisers, operation 20A-02, and the glow plugs, operation 23C-01, to prevent possible damage to their tips.

11 Remove the setscrew from the timing hole in the top front of the camshaft cover 12A.03/A4. Turn the crankshaft until the timing hole in the front journal of the camshaft aligns with the hole in the cover.

12 Remove the starter motor, operation 23B-01 and fit the anti-rotation tool PD.203 to the flywheel.

13 Remove the timing case cover, operation 15A-01 and remove the camshaft pulley, operation 15A-06.

14 Remove the setscrew which is fitted through the camshaft cover into the timing case (A1).

Vehicle engines: Remove the setscrew which is fitted through the timing case into the camshaft cover. Later engines: Remove the setscrew which fastens the timing case to the cylinder head (A3).

15 Release evenly the setscrews of the cylinder head in the reverse sequence to that shown in figure 12A.09/A. Remove the setscrews and remove the head (B) - ensure that the camshaft does not hit the timing case. Put the head on a flat surface which will not damage the bottom face.

16 Check the top face of each cylinder head setscrew for centre punch marks. If there are four centre punch marks on the setscrew head, it has been tightened four times in service and it cannot be used again. Also check the setscrews for distortion with a straight edge held along the setscrew. If there is a visual reduction in the diameter of the stem or of the thread that has not been in engagement with the cylinder head, the setscrew must be discarded.

17 Remove the cylinder head gasket.

To fit

Special tools:

Angle gauge, to tighten cylinder head setscrews, MS.1531

- 1 Clean the bottom face of the cylinder head and the top face of the cylinder block. Ensure that there is no debris in the cylinder bores.

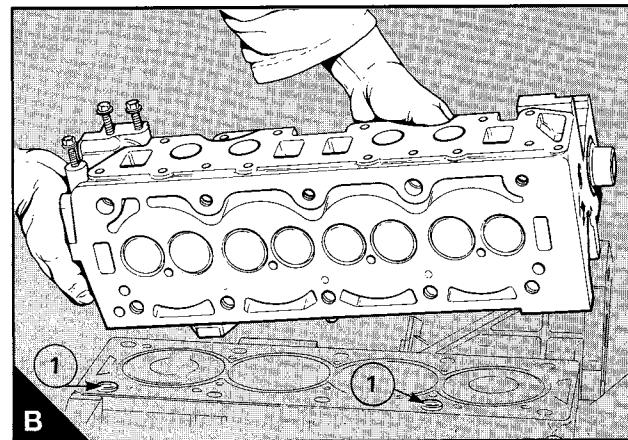
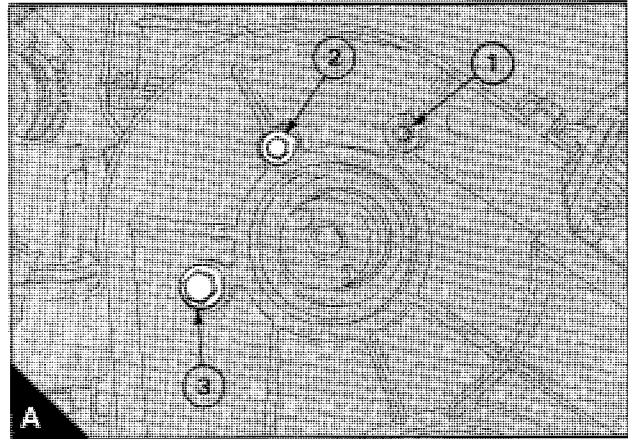

2 Ensure that numbers 1 and 4 pistons are at TDC and that the timing pin is fitted through the backplate or through the flywheel housing into the timing hole in the flywheel.

3 Ensure that the two location thimbles (12A.08/B1) are in position in the top face of the cylinder block and fit the cylinder head gasket without jointing compound. The gasket will only fit in one position over the thimbles.

4 Ensure that the timing pin is fitted through the camshaft cover into the timing hole in the camshaft. Put the cylinder head in position over the thimbles. Engage the cylinder head setscrews with the longer setscrews fitted at the ends of the head. Tighten evenly all the setscrews in the sequence shown in figure (A) to a torque of 50 Nm (37 lbf ft) 5,1 kgf m. Tighten all the setscrews again, in the same sequence, to a torque of 100 Nm (74 lbf ft) 10,2 kgf m. Finally tighten the setscrews, in the same sequence, another quarter of a turn (90°). Tool MS.1531 can be used for this operation (B). Fit the tool between the socket and the handle. Put the stop (B1) against a suitable protrusion on the cylinder head to prevent movement of the degree dial in a clockwise direction. Turn the pointer to align with the 90° mark on the degree dial. Tighten the setscrew until the pointer aligns with the zero position.

If no tool is available, make a suitable mark on the flange of each setscrew (C1). Make other marks on the cylinder head (C2) at 90° clockwise to the marks on the setscrews. Tighten each setscrew in the correct sequence until the marks on the flange are next to, and in line with, the marks on the cylinder head (C3). The setscrews do not need to be tightened again with the engine hot or after a period in service.

If the original setscrews have been fitted again, mark the top of each setscrew with a centre punch to indicate that it has been tightened in service. A maximum of four centre punch marks is permissible.

5 If necessary, fit the inlet and the exhaust manifolds, section 18. Marine engines: Fit the heat exchanger/manifold/header tank assembly, operation 21A-12 and fit the inlet manifold.

6 Connect the air filter and the exhaust pipe.

7 Fit the setscrews which fasten the timing case to the cylinder head (12A.08/A1) and to the camshaft cover 12A.03/A1 (and 12A.03/A2 on some vehicle engines).

8 Fit the camshaft pulley, fit the timing belt and check the belt tension, see section 15.

9 Check the timing of the fuel injection pump, operation 17A-03 and remove the timing pins. Remove the anti-rotation tool and turn the crankshaft through two revolutions to ensure that there is no restriction to movement.

10 Fit the starter motor, operation 23B-01.

11 Fit the glow plugs, operation 23C-01.

12 Fit the atomisers, operation 20A-02.

13 Fit the high-pressure fuel pipes and tighten the pipe nuts to 18 Nm (13 lbf ft) 1,8 kgf m. Ensure that a separate spanner is used to prevent movement of the outlets of the fuel injection pump.

14 Fit the fuel filter and the low-pressure fuel pipes between the fuel injection pump and the fuel filter.

15 If necessary, fit the fuel lift pump, operation 20A-03 and the exhauster, operation 24A-01. Connect the pipes to the fuel lift pump and the exhauster.

16 Fit the timing case cover, operation 15A-01.

17 If necessary, fit the turbocharger, operation 18A-02.

18 Connect the coolant by-pass and the coolant outlet pipe.

Marine engines: Connect the raw water pipes to the heat exchanger and to the raw water pump. If necessary, connect the heater hoses.

19 Connect the electrical connections to the cylinder head and to the thermostat housing.

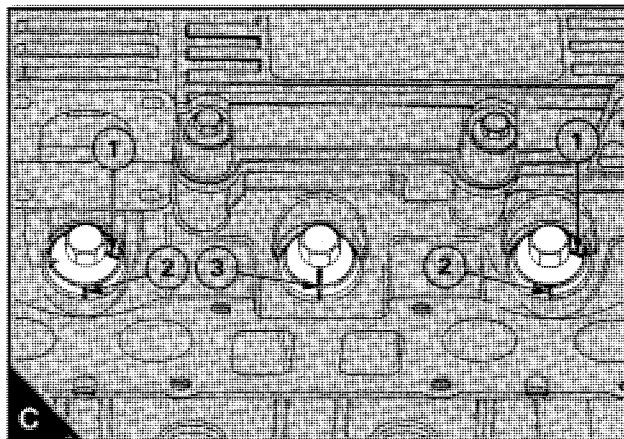
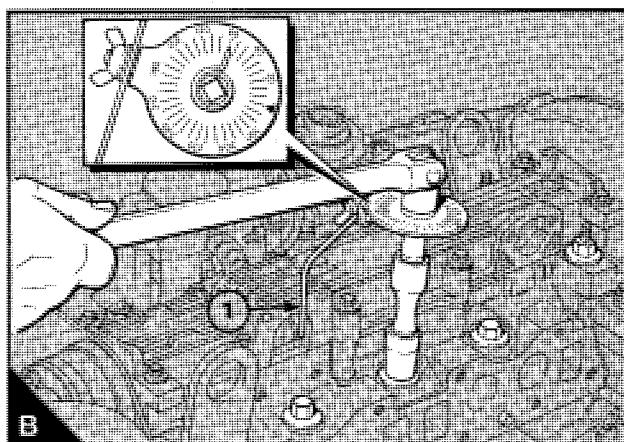
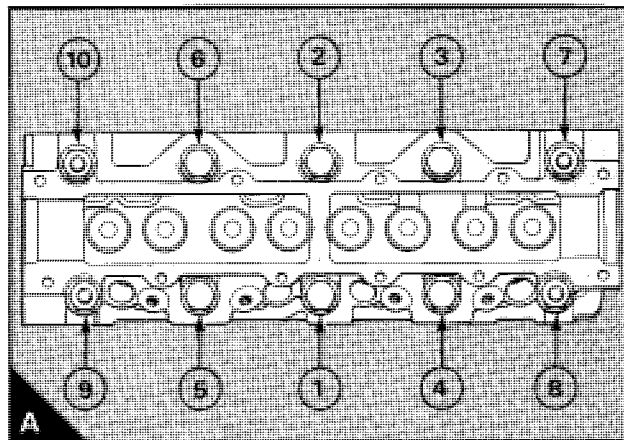

20 Fill the cooling system.

For marine engines: see operation 21A-02.

21 Connect the battery.

22 Eliminate air from the fuel system, operation 20A-10.

23 Start the engine and check for leaks.

Valves and valve springs

To remove and to fit

12A-08

Special tools:

Valve spring compressor, MS.1519A

To remove

- 1 Remove the cylinder head, operation 12A-07.
- 2 Remove the rear cover of the camshaft or, for marine engines, remove the raw water pump, operation 21A-06.
- 3 Remove the camshaft cover, operation 12A-01.
- 4 Remove the tappets and the shims and keep the tappet and shim from each valve together in a marked container to ensure that they can be fitted in their original positions.
- 5 Clean the bottom face of the cylinder head and check the depth of the heads of the valves below the face of the cylinder head, see operation 12A-09.
- 6 Make a suitable mark on the heads of the valves to ensure that the valves can be fitted in their original positions, if they are to be used again.
- 7 Use the valve spring compressor to compress the valve spring (A1). Ensure that the valve spring is compressed squarely or damage can occur to the valve stem. Remove the split collets (B1).
- 8 Release the valve spring compressor and remove the valve spring cap (B2), the valve spring (B3), the valve stem seal (B4) and the spring seat washer (B5). Remove the exhaust valve (B6) or the inlet valve (B7).
- 9 Repeat items 7 and 8 for the other valves.

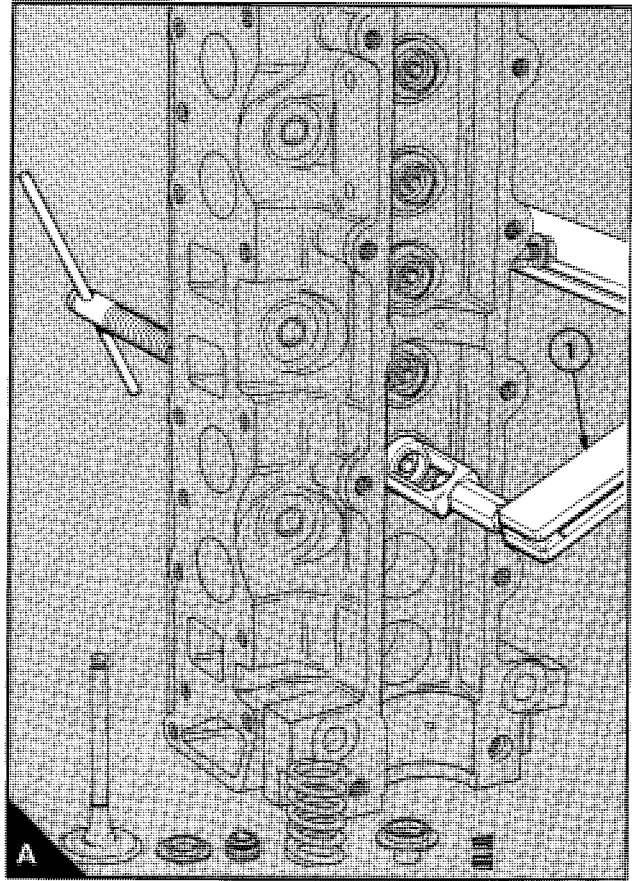

To fit

The components of the valve assembly are shown in B.

- 1 Ensure that all the components are clean.
- 2 Lubricate the valve stems with clean engine oil and fit the valves (B6/B7) in their relevant guides. Ensure that the valve head depth is correct, see operation 12A-09.
- 3 Fit the spring seat washers (B5). Fit new valve stem seals (B4) on the valve guides. Fit the valve springs (B3) and the valve spring caps (B2).
- 4 Use the valve spring compressor to compress the valve spring and fit the collets (B1). Ensure that the valve spring is compressed squarely or damage can occur to the valve stem.
- 5 Lubricate the shims and the tappets. Fit each shim in the top of the spring cap of the relevant valve and fit the tappet on the top of the shim.
- 6 Put the camshaft in position and check the tappet clearances as shown in operation 12A-02. Adjust the clearances as necessary.
- 7 Fit the camshaft and the camshaft cover, operation 12A-02.
- 8 Fit the rear cover of the camshaft or, for marine engines, fit the raw water pump, operation 21A-06.
- 9 Fit the cylinder head, operation 12A-07.

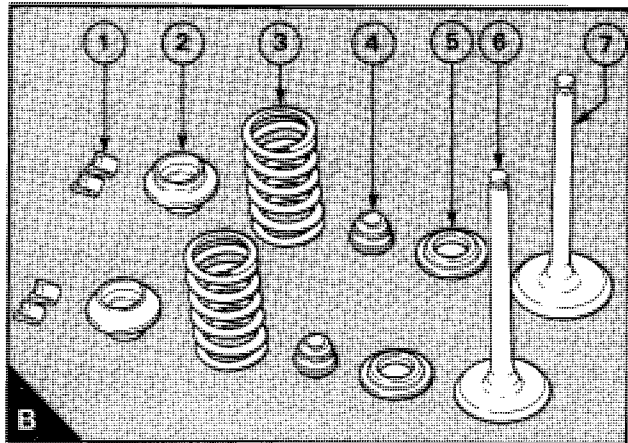

To inspect and to correct

12A-09

Special tools:

Gauge, valve depth, PD.197

Dial gauge for use with PD.197, PD.208

- 1 Check the depth of the valves below the face of the cylinder head before the valve springs are removed. Ensure that the heads of the valves and the bottom face of the cylinder head are clean. Put the valve depth tool on the face of the cylinder head and set the dial gauge to zero. Carefully put the valve depth tool in position

over the head of each valve (A) and make a note of the measurement. The limits for the valve head depth are given in section 11C. If a valve is deeper than the maximum limit, check the valve depth with a new valve in position and, if the valve depth is still below the limit, a new valve seat insert can be fitted, operation 12A-14.

2 Check the valves for cracks. Check the stems of the valves for wear and for correct fit in their valve guides.

3 Check that the seat faces of the valves are not badly burnt or damaged. Seat faces of valves which are damaged can be ground on a special machine. Valves which have only little damage can be lapped to their valve seats. When new valves are fitted, the valve depths must be checked, see 1.

4 Check that the load on the valve springs is correct at their fitted length, see section 11C.

Fit new valve springs at every complete engine overhaul.

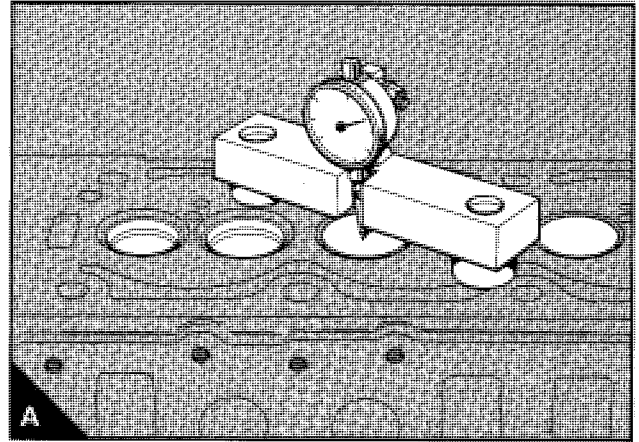

Valve guides

To inspect

12A-10

Check the valve guides for wear. The maximum clearance between the valve stem and the bore of the guide is 0,13 mm (0.005 in). If the clearance with a new valve fitted is more than the limit, then a new valve guide must be fitted.

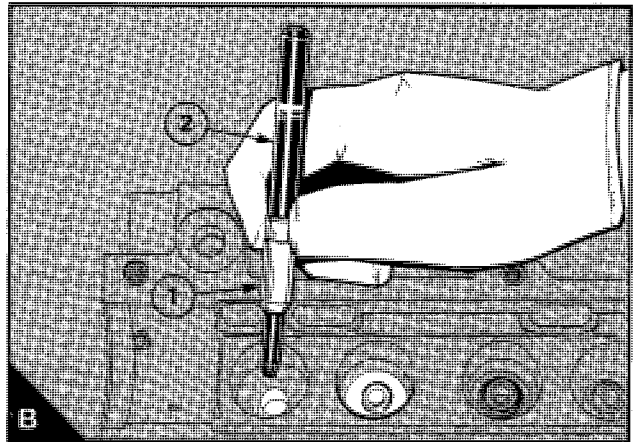

To remove and to fit

12A-11

Special tools:

Remover/replacer for valve guides, PD.189

Reamer for new valve guides, PD.196

To remove

1 Ensure that the face of the cylinder head and the base of a suitable press are clean.

2 Heat the whole cylinder head slowly and evenly to approximately 100°C (212°F) and put the head on the press, with the head face downward. Ensure that the head face is not damaged during this operation.

Attention: Use suitable gloves as a protection against hot metal.

3 Put the narrow shaft of tool PD.189 in the guide and press out the guide. Repeat as necessary, if other guides need to be renewed.

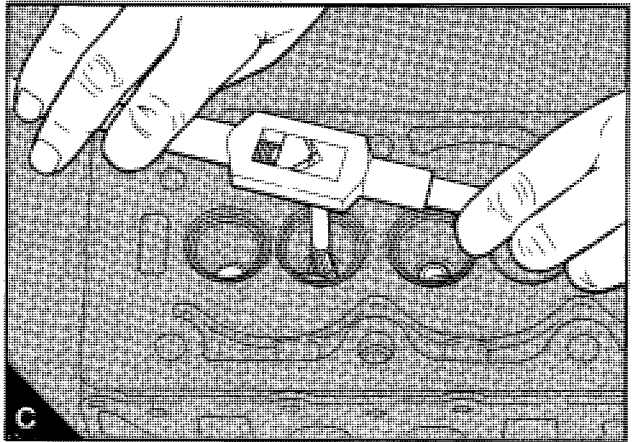

To fit

1 Clean the parent bore for the valve guide and ensure that it is not damaged.

2 Heat the whole cylinder head slowly and evenly to approximately 100°C (212°F). Put the head on the press, with the head face downward and with a flat plate underneath the valve port. Ensure that the head face is not damaged during this operation.

Attention: Use suitable gloves as a protection against hot metal.

3 Put the guide (B1) on to the narrow shaft of the tool PD.189 (B2) with the chamfer towards the narrow end of the tool (B). Enter the chamfer end of the guide into the top of the parent bore and press in the guide until the end of the tool is in contact with the flat plate. Check that the guide protrusion above the location face for the valve spring is 10 mm (0.39 in).

4 Allow the head to cool.

5 Ream the bore of the new guide(s) with reamer PD.196 (C).

Cylinder head

To inspect and to correct

12A-12

- 1 Remove the cylinder head assembly, operation 12A-07.
- 2 Remove the thermostat housing.
- 3 Remove the rear cover of the camshaft or, for marine engines, remove the raw water pump, operation 21A-06.
- 4 Remove the camshaft cover, operation 12A-01 and the camshaft.

Remove the tappets and the shims and keep the tappet and shim from each valve together in a marked container to ensure that they can be fitted in their original positions.

- 5 Inspect the cylinder head for signs of gas or coolant leakage.
- 6 Remove the valve springs and the valves, operation 12A-08.
- 7 Clean the face of the cylinder head. Clean the passages for coolant and for lubricating oil. The water jacket can be cleaned with a special solvent which must be used in accordance with the manufacturer's instructions.
- 8 Test the cylinder head for leaks at the pressure given in section 11C.
- 9 When the cylinder head is thoroughly clean, check it for cracks. Examine carefully the areas around the valve seats and around the holes for the atomiser nozzles.

10 Use a straight edge and feeler gauges to check the cylinder head for distortion across and along its bottom face (A). If the distortion is more than 0,10 mm (0.004 in), the bottom face can be machined. Remove only the minimum material and ensure that the thickness of the cylinder head will not be less than 119,85 mm (4.718 in) after the cylinder head has been machined.

Attention: After the cylinder head has been machined, the valve seats must be corrected to give the correct valve head depth. It is advisable to work to the minimum limit to allow for later wear.

- 11 Check the valve seats for wear and for damage.
- 12 Before any work is done on the valve seats, ensure that there is no wear on the valve guides, see section 11C. If the valve guide wear is more than the limit, then the valve guide must be renewed, operation 12A-11.
- 13 Where there is little damage, the valve and valve seat can be lapped. When the valve seats are lapped keep the seat as narrow as possible and ensure that all the compound used to lap the valve and seat is removed.
- 14 More badly damaged valve seats can be corrected by use of the cutter tool, operation 12A-13, or new inserts can be fitted, operation 12A-14.
- 15 Fit the valve springs and the valves, operation 12A-08.

16 Fit the tappets and the shims in their relevant positions. Put the camshaft in position, check the tappet clearances, operation 12A-02 and adjust if necessary, operation 12A-03.

Attention: When the cylinder head is not fitted to the cylinder block, the clearances are increased by 0,05 mm (0.002 in) as follows:

- Clearance check
- Inlet - 0,30/0,40 mm (0.012/0.016 in)
- Exhaust - 0,40/0,50 mm (0.016/0.020 in)
- Permissible clearance limits
- Inlet - 0,25/0,45 mm (0.010/0.018 in)
- Exhaust - 0,35/0,55 mm (0.014/0.022 in)
- Clearances for shim calculations
- Inlet - 0,35 mm (0.014 in)
- Exhaust - 0,45 mm (0.018 in)

- 17 Fit the camshaft and the camshaft cover, operation 12A-01.
- 18 Fit the rear cover of the camshaft or, for marine engines, fit the raw water pump, operation 21A-06.
- 19 Fit the thermostat housing.
- 20 Fit the cylinder head assembly, operation 12A-07.

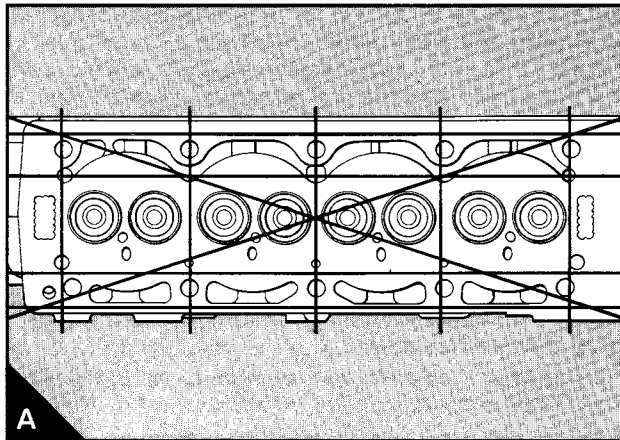

To correct a valve seat
with a valve seat cutter

12A-13

Special tools:

Pilot for use with valve seat cutters, MS.150-7
Handle set for use with valve seat cutters, MS.76B
Cutter for valve seats, MS.275

- 1 If the valve guide is worn, renew it, operation 12A-11.
 - 2 Fit the pilot in the valve guide and tighten the pilot.
 - 3 Fit the cutter on the pilot with the 46° side towards the valve seat and fit the handle (A). Ensure that the cutter is not allowed to fall on to the seat as this can damage the blades.
 - 4 Carefully turn the cutter in a clockwise direction. Remove only the minimum material to ensure a good seat. Keep the seat as narrow as possible.
 - 5 When the seat is correct, remove the cutter and the pilot. Remove any debris from the area of the valve seat and the port.
 - 6 Fit the valve and lightly lap the valve and the seat.
 - 7 Check that the valve depth is within limits, see section 11C.
- If a valve seat has become too damaged or too worn, it can be renewed, operation 12A-14.

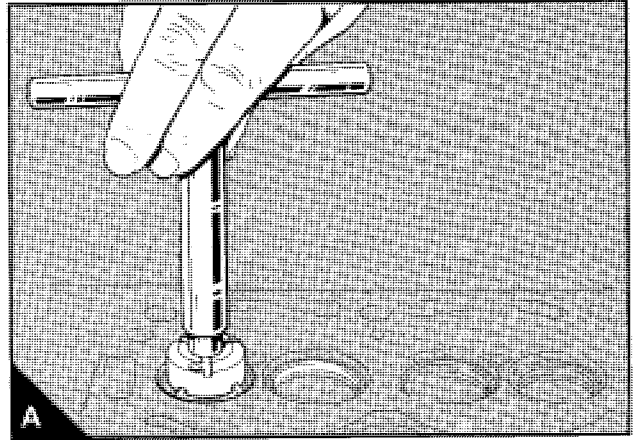

To fit a valve seat insert

12A-14

- 1 Fit a new valve guide, operation 12A-11.
 - 2 Machine a small segment from the inside of one side of the insert to a depth of 8,25 mm (0.325 in) from the face of the cylinder head. Break the insert at its thinnest point and remove it from the recess. Ensure that the recess is not damaged during this operation.
 - 3 The valve seat insert must be fitted with the cylinder head hot and the insert cold. Heat the whole cylinder head slowly and evenly to approximately 100°C (212°F) and cool the insert, if possible, in liquid nitrogen to -35°C (-31°F). If liquid nitrogen is not available, reduce the temperature of the insert as far as possible in a deep freeze unit. Fit the insert in position with the outside chamfer to the inside of the head. Ensure that the bottom of the insert is in contact with the bottom of the recess.
- Attention:** Use suitable gloves as a protection against the hot cylinder head and the cold insert.
- 4 Cut the valve seat, operation 12A-09 and lightly lap the valve and the valve seat. Ensure that the depth of the valve head below the face of the cylinder head is within the production limits, see section 11C. Work as near as possible to the minimum figure to allow for future wear on the valve seat.



Piston and connecting rod assemblies

13

	General description	13A.02
	Big end bearing		
13A-01	To remove and to fit	13A.03
13A-02	To inspect	13A.03
	Piston and connecting rod assembly		
13A-03	To remove and to fit	13A.04
	Piston rings		
13A-04	To remove and to fit	13A.06
	Piston and connecting rod assembly		
13A-05	To dismantle and to assemble	13A.07
	Piston and rings		
13A-06	To inspect	13A.08
	Connecting rod		
13A-07	To inspect	13A.08
	Small end bush		
13A-08	To remove and to fit	13A.08
	Piston cooling jets		
13A-09	To remove and to fit	13A.09
13A-10	To check the jet alignment	13A.09

General description

The combustion chamber in the top of the piston has a special "swirl lip" at the top to give an efficient mix of fuel and air. There are cut-outs in the top of the pistons for some engines (A) to ensure that there is clearance for the valves and for the glow plugs.

The pistons have two compression rings and an oil control ring. The groove for the top ring is machined in a hard metal insert to reduce wear of the groove. Axial location of the fully floating gudgeon pin is by circlips. There is a steel insert in the piston skirt to control piston expansion.

The connecting rods are machined from "H" section forgings of steel. The location of the bearing caps to the connecting rods is made by tight fit connecting rod bolts.

The connecting rod assemblies are fitted in sets with a maximum weight range of 7 grams (0.25 oz) within each engine.

Turbocharged vehicle and marine engines have cooling jets fitted in the cylinder block to spray lubricating oil onto the inner surface of the piston.

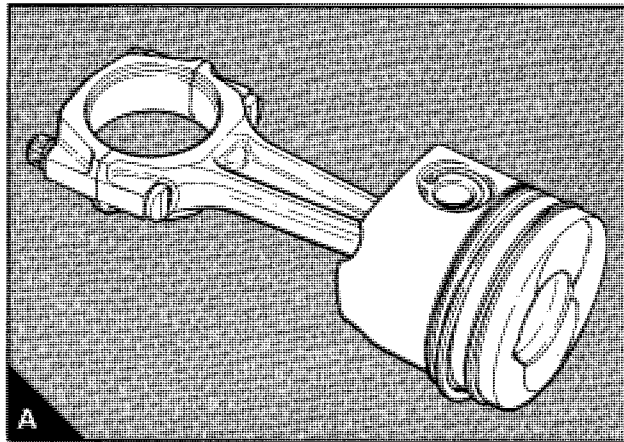

Big end bearing

To remove and to fit

13A-01

To remove

- 1 Disconnect the battery.
 - 2 Drain the engine lubricating oil.
 - 3 Remove the lubricating oil sump, operation 19A-03.
 - 4 Remove the lubricating oil strainer and suction pipe, operation 19A-04.
 - 5 Turn the crankshaft until the relevant connecting rod is at its lowest position.
 - 6 Release the nuts and remove the bearing cap (A). Do not try to remove the connecting rod bolts.
 - 7 Remove the lower half bearing from the cap but keep it with its relevant cap.
 - 8 Fit a suitable length of rubber or plastic hose to each connecting rod bolt to protect the crank pin. Carefully push the connecting rod up the cylinder bore just enough to allow access to the upper half bearing. Remove the bearing from the connecting rod. Keep the bearings from the connecting rod and cap together.
- Attention:** Do not allow the connecting rod to hit the piston cooling jet, if fitted.

To fit

- 1 Clean the bearing faces of the connecting rod and the crank pin.
- 2 Clean the complete bearing and lubricate the bearing surface and the crank pin with clean engine lubricating oil. Fit the upper half bearing to the connecting rod with the location tag fitted correctly in its recess (A1). Fit the connecting rod to the crankpin. Ensure that the assembly number on the connecting rod (B) is on the same side as the other connecting rods.
- 3 Clean, lubricate and fit the lower half bearing into the cap. Ensure that the location tag is fitted correctly in its recess (A2). Remove the protection hoses from the connecting rod bolts and ensure that the bolts have not been moved. Fit the cap to the connecting rod. Ensure that the assembly number on the cap is the same as that on the connecting rod (B) and that both of the assembly numbers are on the same side.
- 4 Fit new nuts to the connecting rod bolts and tighten them gradually and evenly to the recommended torque of 47 Nm (35 lbf ft) 4,8 kgf m.
- 5 Ensure that the crankshaft turns freely.
- 6 Fit the lubricating oil strainer and suction pipe, operation 19A-04.
- 7 Fit the lubricating oil sump, operation 19A-03 and fill the sump to the correct level with lubricating oil of an approved grade.
- 8 Connect the battery.

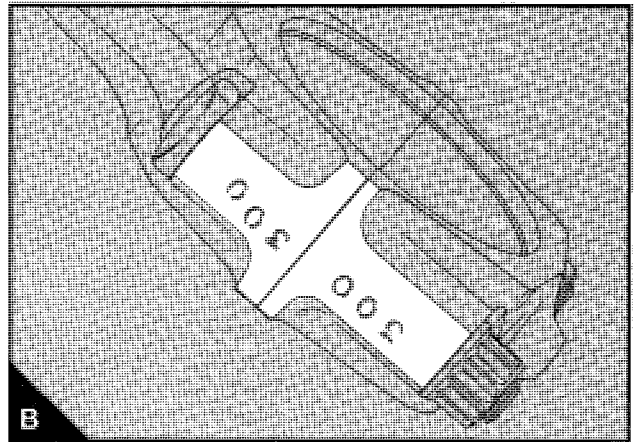
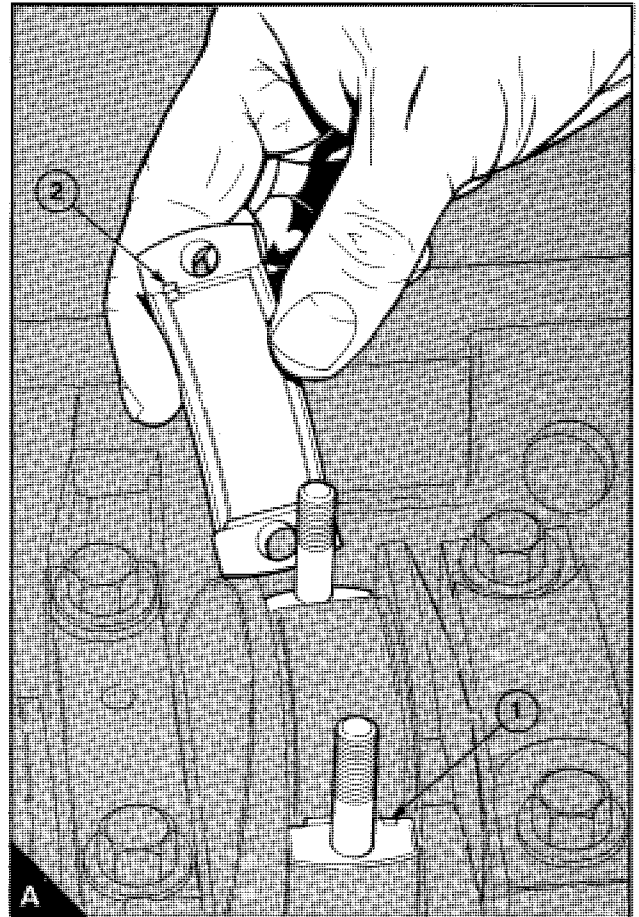

To inspect

13A-02

Check the bearings and the crank pin for wear or other damage.

Piston and connecting rod assembly

To remove and to fit

13A-03

To remove

- 1 Disconnect the battery.
 - 2 Drain the lubricating oil and the cooling system, see section 21 for marine engines.
 - 3 Remove the cylinder head assembly, operation 12A-07.
 - 4 Turn the crankshaft until all the pistons are at the same height in their bores. Put a suitable clean rag on the top of the piston to fill the bore. Remove all carbon from the top of the cylinder bore with a coarse grade of emery cloth. The emery cloth should be wet with lubricating oil to hold the debris. Obtain a smooth surface to the cleaned area with a fine grade of emery cloth. Clean the bore and remove the rag protection.
 - 5 Remove the lubricating oil sump, operation 19A-03.
 - 6 If necessary, remove the lubricating oil strainer and suction pipe, operation 19A-04.
 - 7 Check that all the connecting rods and their caps are marked with their relevant cylinder number (A). If they are not marked, mark them 1 to 4 with number 1 at the timing case end of the engine.
 - 8 Remove the big end cap and the big end bearings from the connecting rod, operation 13A-01. Keep the bearings and cap together to ensure that they can be fitted in their original positions.
 - 9 Fit protection sleeves made of rubber or plastic to the connecting rod bolts (B1). Push the piston and the connecting rod out through the top of the cylinder bore. A suitable tool can be made for this operation with a "U" bend of metal tube and two lengths of plastic pipe (C).
- Attention:** Do not allow the connecting rods to hit the piston cooling jets, if fitted. If a cooling jet is hit, check its alignment, operation 13A-10 and, if necessary, renew it.
- 10 Inspect the crank pin for damage.

To fit

Special tools:

Piston ring compressor, 38U3

Piston height tool, PD.197

Plate for measurement of piston height, PD.197-1

Dial gauge for use with PD.197, PD.208

- 1 Ensure that the piston, the cylinder bore, the crank pin and the big end of the connecting rod are clean. Lubricate the piston and the cylinder bore with clean engine lubricating oil.
- 2 Turn the crankshaft until the relevant crank pin is at its lowest position. Lubricate the crank pin with clean engine lubricating oil.
- 3 Fit a suitable length of rubber or plastic hose to each connecting rod bolt to protect the crank pin. Fit the upper half bearing to the connecting rod. Ensure that the location tag is fitted correctly in its recess. Lubricate the bearing with clean engine lubricating oil.
- 4 Ensure that the gaps of the piston rings are 120° apart and compress the rings with the piston ring compressor (D1). Ensure that the protrusions which are pressed in one edge of the tool are at the bottom.
- 5 Enter the assembly into its correct bore. When the piston is fitted, the arrow on the top of the piston must be towards the front (timing case end) of the engine (D). In this position the combustion bowl in the top of the piston will be towards the fuel injection pump side of the engine. There are also front indicators on the bottom of the piston and on the connecting rod and these must be on the same side, see 13A.07/B.

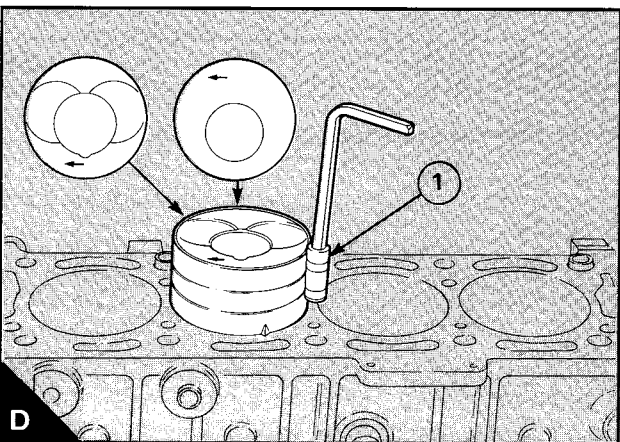
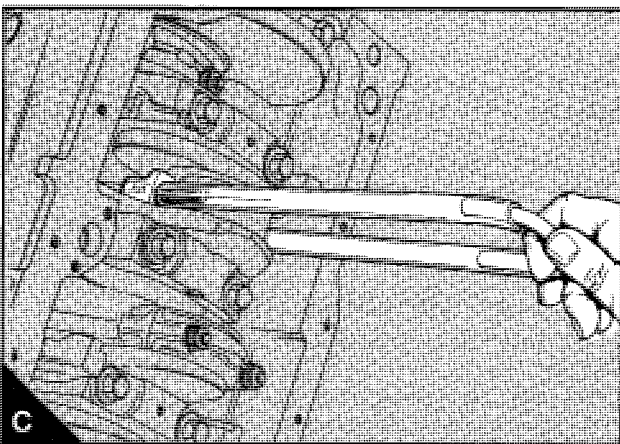
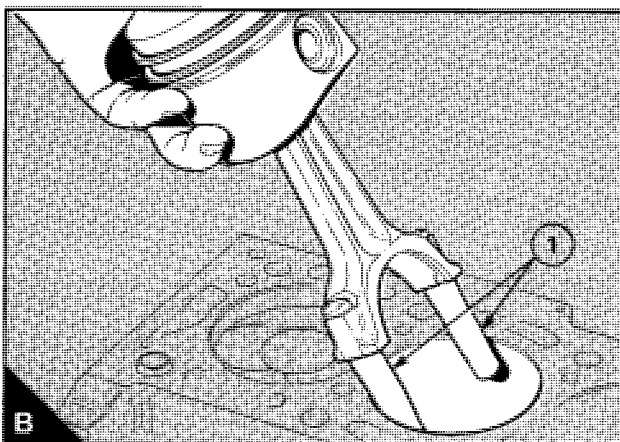
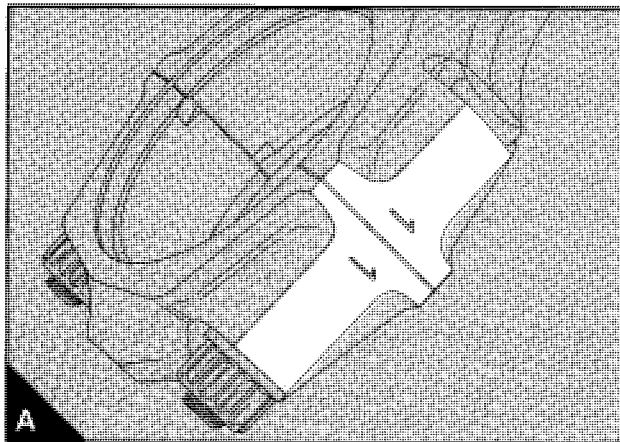

6 Push the piston and connecting rod assembly through the bore and onto the crank pin. If piston cooling jets are fitted, the assembly must be turned to ensure that the connecting rod will not hit the jet as the rod is fitted. When the connecting rod has passed the piston cooling jet, turn the connecting rod until the arrow on the top of the piston is towards the front of the engine.

7 Remove the protection hoses from the big end bolts. Clean the connecting rod cap and the lower half bearing. Fit the bearing to the cap with the location tag fitted correctly in its recess. Lubricate the bearing with clean engine lubricating oil. Fit the cap and ensure that the assembly number is the same as that on the connecting rod and that the numbers are on the same side. Fit new nuts to the big end bolts and tighten them gradually and evenly to 47 Nm (35 lbf ft) 4,8 kgf m.

8 Check that the crankshaft will turn freely.

9 Check the piston height above the top face of the cylinder block with the piston height tool (A). A 4 mm (0.157 in) plate, number PD.197-1 is available to allow the piston height to be measured above the centre of the piston. Put the measurement tool on a flat surface with the plate under the gauge plunger and turn the gauge dial to the zero position. Turn the crankshaft until the piston is approximately at TDC. Put the plate on the top of the piston. Put the measurement tool over the cylinder bore with the plunger of the gauge in contact with the centre of the plate. Turn the crankshaft to bring the piston to its highest position and make a note of the gauge indication. The correct piston height is given in section 11C. If a new lower grade of service piston has been fitted, see operation 13A-05, the piston height can be 0,10 mm (0.004 in) below the bottom limit. The piston must not be higher than the top limit. It is not permissible to remove metal from the top of the piston.

10 If necessary, fit the lubricating oil strainer and suction pipe, operation 19A-04.

11 Fit the lubricating oil sump, operation 19A-03.

12 Fit the cylinder head assembly, operation 12A-07.

13 Fill the sump to the correct level with lubricating oil of an approved grade.

14 Fill the cooling system, see operation 21A-02 for marine engines.

15 Connect the battery.

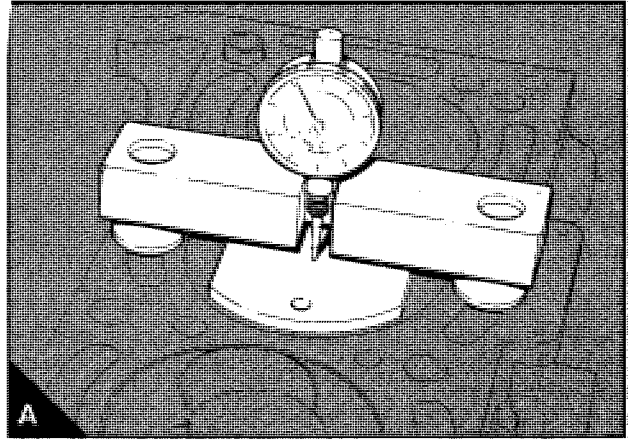

Piston rings

To remove and to fit

13A-04

To remove

Remove the piston rings with a suitable ring expander. Only increase the ring gaps enough to ensure that the ends of the rings do not damage the piston. Keep the rings with their relevant piston.

To fit

Use a suitable ring expander to fit the piston rings. Only increase the ring gaps enough to ensure that the ends of the rings do not damage the piston.

- 1 Fit the spring of the oil control ring in the bottom groove with the latch pin inside both ends of the spring (A). Fit the oil control ring over the spring (B). Ensure that the ring gap is at 180° to the latch pin.
- 2 Fit the cast iron ring with the tapered face into the second groove with the word "TOP", or the manufacturer's symbol, towards the top of the piston. New piston rings have a green identification mark. This must be on the left of the ring gap when the ring is fitted and the piston is upright.
- 3 Fit the barrel face ring with the molybdenum insert into the top groove. The word "TOP", the manufacturer's identification mark or the internal chamfer, must be towards the top of the piston. New piston rings have a red identification mark. This must be on the left of the ring gap when the ring is fitted and the piston is upright.
- 4 Ensure that the ring gaps are 120° apart.

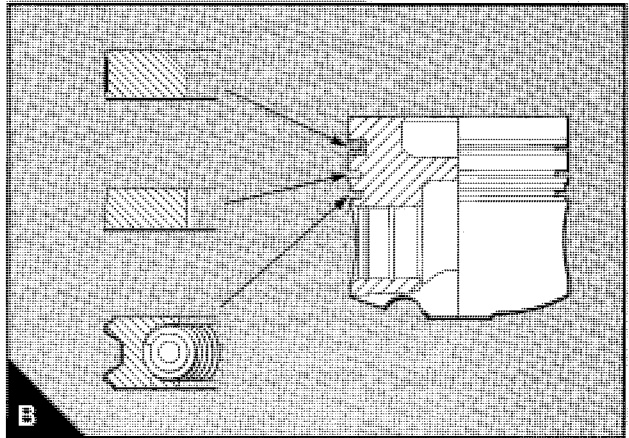
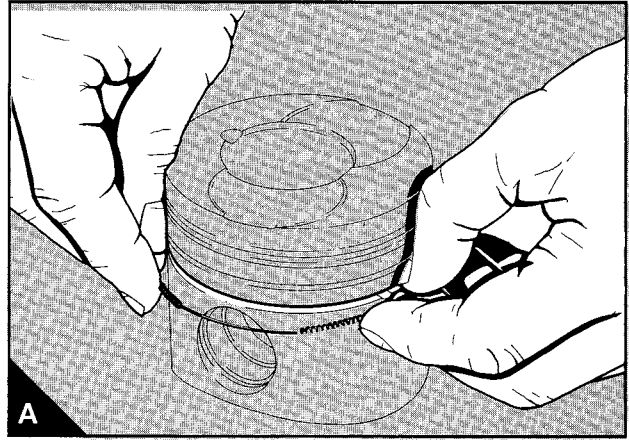

I Piston and connecting rod assembly

To dismantle and to assemble

13A-05

To dismantle

- 1 Remove the piston rings, operation 13A-04.
- 2 Remove the circlips which retain the gudgeon pin.
- 3 Put a temporary mark on the piston to indicate the cylinder number as shown on the connecting rod. Put the mark on the piston on the same side as the mark on the big end to ensure that they are assembled correctly.
- 4 Push the gudgeon pin out by hand. If the gudgeon pin is tight, heat the piston to 40°/50°C (100°/120°F) for easy gudgeon pin removal.

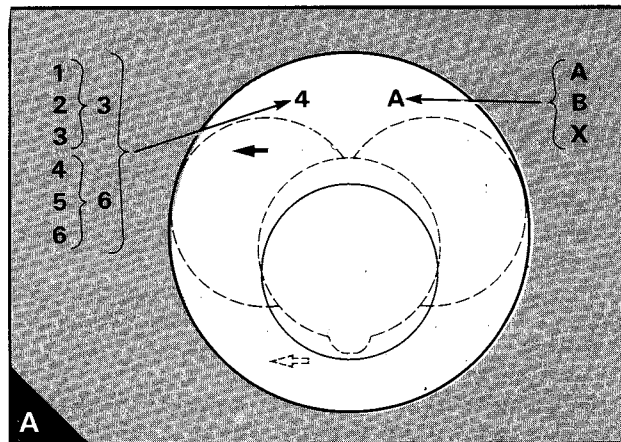

To assemble

- 1 Clean the bore of the small end bush and lubricate it with clean engine lubricating oil.
- 2 Fit a new circlip in the circlip groove of one of the gudgeon pin bosses. Ensure that it fits correctly in the groove.
- 3 If the original piston is used, ensure that it is assembled to the correct connecting rod and is used in the original cylinder. If a new piston is to be fitted, ensure that it is of the correct height grade. In the factory, six different height grades can be used. The grades are identified by numbers which are stamped on the top of the piston (A). Number 1 is the highest piston and number 6 is the lowest piston. In service, only grades 3 and 6 will be available. Grade 3 must be used if the original piston is stamped 1, 2 or 3. Grade 6 must be used if the original piston is stamped 4, 5 or 6. Two different diameter grades "A" and "B" are also used in the factory. Only the smaller diameter piston "A" will be supplied in service for the standard size bore. A grade "X" piston will be available for bores which have been bored 0,50 mm (0.020 in) oversize in diameter in service. The diameter grades are stamped on a machined pad at the top rear of the right side of the cylinder block (16A-04/C). If a bore has been bored oversize in service, the original grade letter for that bore should be over stamped with a letter "X".

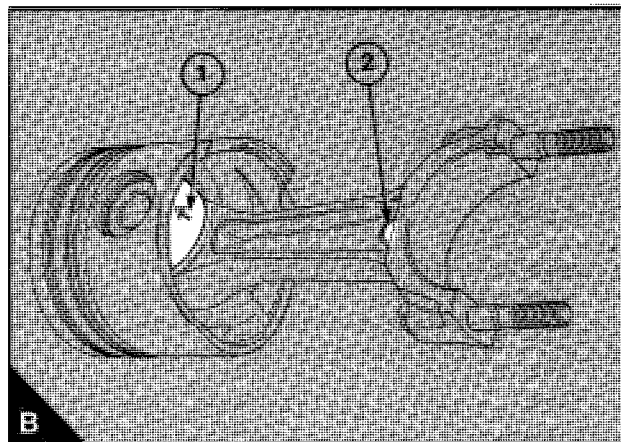

Attention: Earlier Prima; M60 and M80T engines had pistons with recesses in the top to give clearance for the valves. Later engines may be fitted with pistons which do not have these recesses.

- 4 With the piston upside down, put the connecting rod in position. The location boss on the rod (B2) must be on the same side as the arrow on the bottom of the piston (B1).
- 5 Lubricate the gudgeon pin bosses with clean engine lubricating oil and push in the gudgeon pin towards the circlip. If the gudgeon pin is a tight fit in the piston, heat the piston to 40°/50°C (100°/120°F) before the gudgeon pin is fitted.
- 6 Fit a new circlip in the groove in the other gudgeon pin boss. Ensure that it fits correctly in the groove.
- 7 Fit the piston rings, operation 13A-04.

Piston and rings

To inspect 13A-06

- 1 Check the piston for wear and other damage.
- 2 Check that the piston rings are free to move in their grooves and that the rings are not broken.
- 3 Remove the piston rings, operation 13A-04. Clean the piston ring grooves and the piston rings.
- 4 Fit new rings in the grooves and check for wear of the ring grooves with feeler gauges (A). Compare the piston ring clearance in the groove to that given for new components in section 11C. Renew the piston, if necessary.
- 5 Ensure that all the carbon has been removed from the top of the cylinder bores. Fit the piston rings in the top part of the bore and measure the ring gap with feeler gauges (B). The coil spring must be fitted to the oil control ring when the gap of this ring is measured. The ring gaps for new components are given in section 11C.

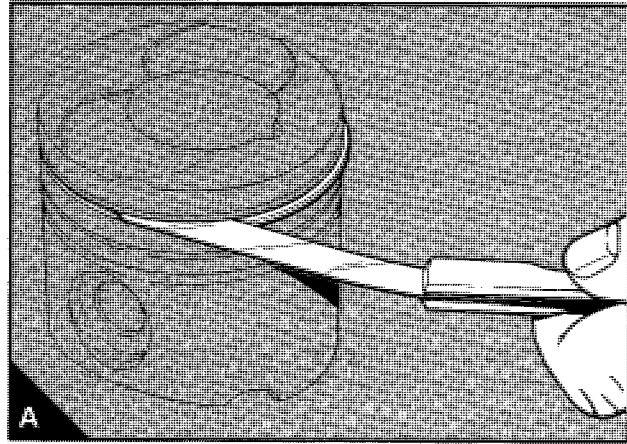

Connecting rod

To inspect 13A-07

Attention: All the connecting rod assemblies fitted in each engine are within a weight tolerance of 7 grams (0.25 oz). In service, new connecting rod assemblies are only available in sets of four. If one or more connecting rod(s) is/are damaged, all four must be renewed.

- 1 Check the connecting rod for distortion, see section 11C.
- 2 Check the small end bush for wear or for other damage and renew it, if necessary.
- 3 Check the fit of the gudgeon pin in the small end bush and check the gudgeon pin for wear, see section 11C.
- 4 Check the condition of the big end bolts. If the thread is damaged or there are indications of stretch, the bolt must be removed from the rod and a new one fitted. The new bolt must be fitted with the location arrows (or the identification mark) on the head of the bolt towards the outside of the big end (C). Ensure that the head of the bolt is in correct contact with the connecting rod.

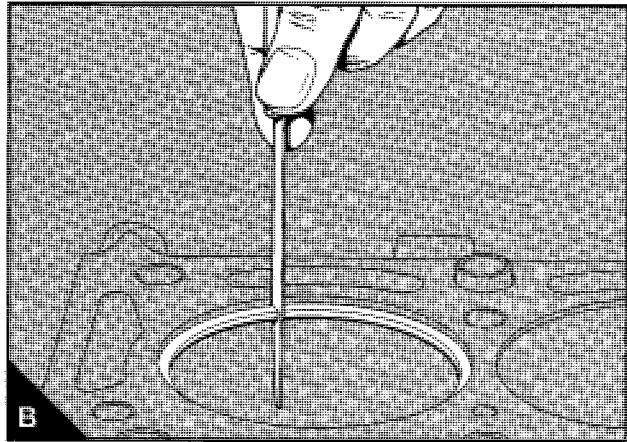

Small end bush

To remove and to fit 13A-08

- 1 Press out the old bush with a suitable adaptor.
- 2 Clean the connecting rod bore and remove any sharp edges.
- 3 Press in the new bush. Ensure that the lubrication hole in the bush is on the same side as, and is aligned with, the hole in the top of the connecting rod.
- 4 Ream the bush to get the correct clearance between the gudgeon pin and the bush, see section 11C.

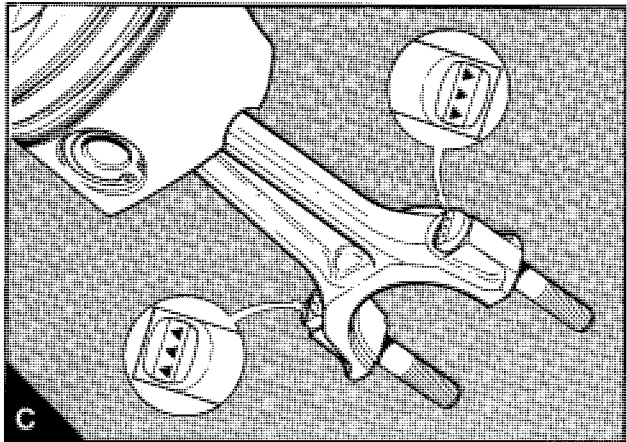

Piston cooling jets

To remove and to fit

13A-09

To remove

Release the banjo bolt and remove the piston cooling jet assembly (A). (The crankshaft is removed in A to show clearly the piston cooling jet.)

To fit

1 Check that the jet tube and the thread of the banjo bolt are not damaged. Renew the jet assembly or the banjo bolt as necessary. There are different types of jet assembly for adjacent bores and the correct assembly must be obtained.

2 Fit the piston cooling jet with the dowel in its location in the cylinder block. Tighten the banjo bolt to 11 Nm (8 lbf ft) 1,1 kgf m.

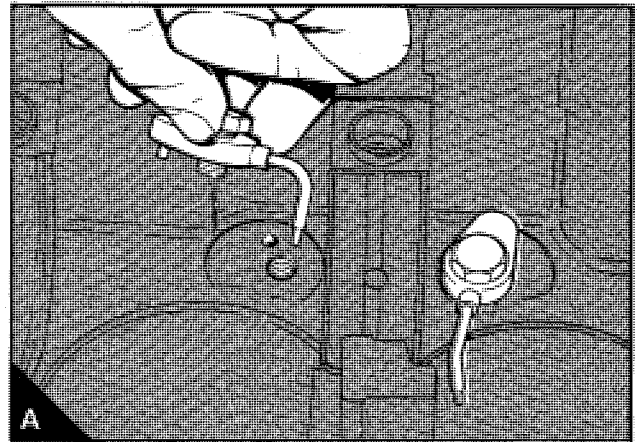

To check the jet alignment

13A-10

Insert a 1.5 mm (0.059 in) diameter rod, of suitable length, into the jet (B). If a suitable rod is not available, reduce the end of a thicker rod to 1.5 mm (0.059 in) diameter for a length of 10 mm (0.4 in). When the rod is inserted into the jet, it must extend out of the top of the cylinder within 5 mm (0.2 in) of the relevant point shown in C.

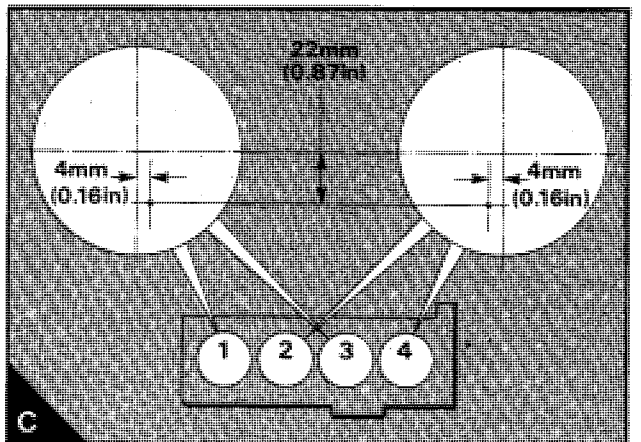
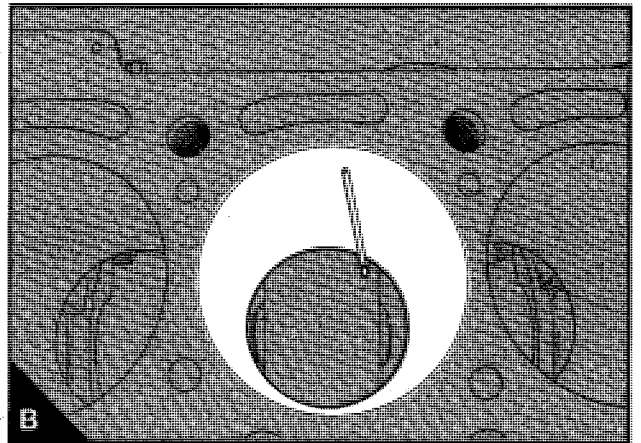

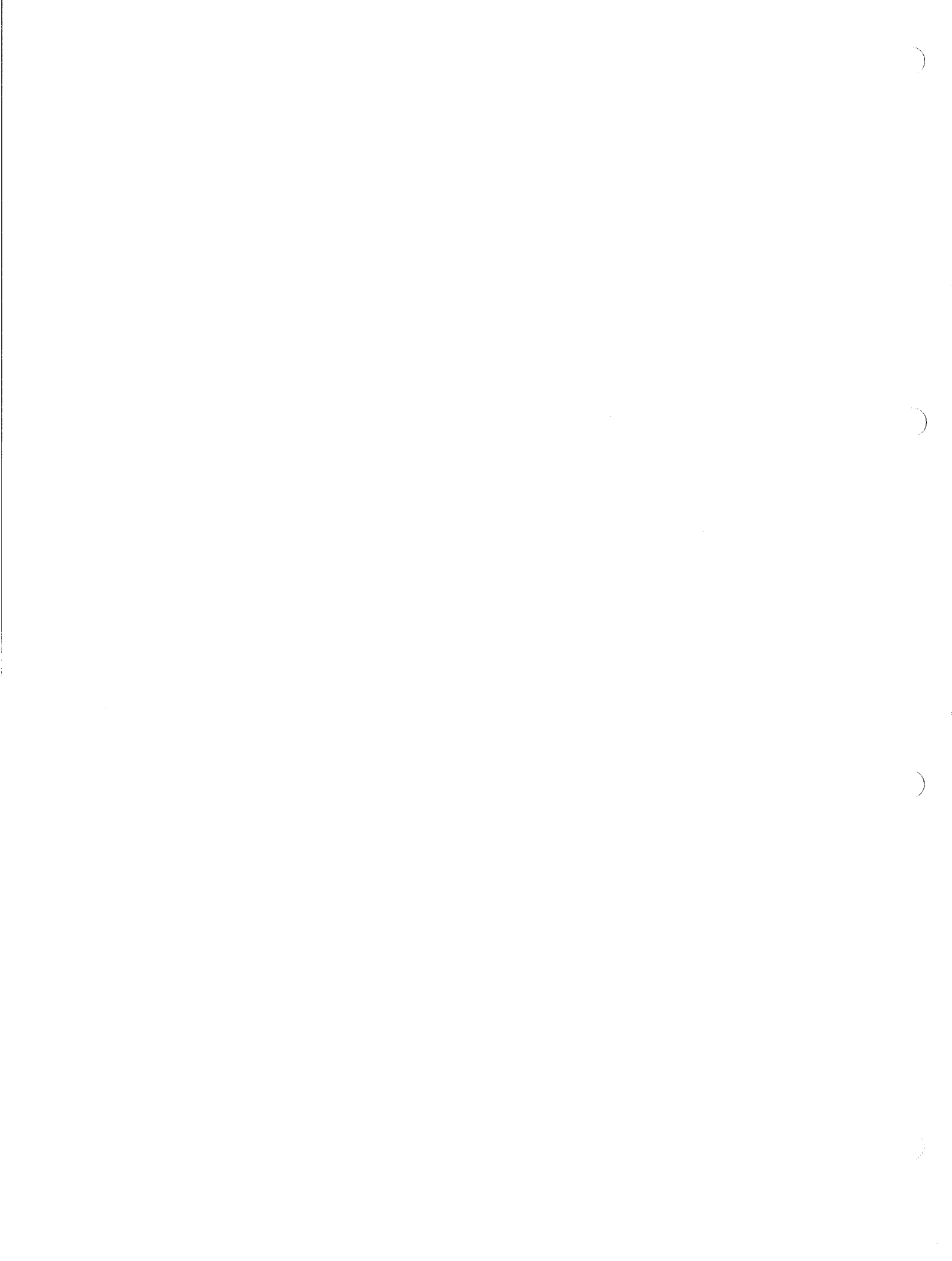

General description

The crankshaft is machined from a casting of spheroidal graphite iron. It has integral balance weights and five main journals.

End-float is controlled by two half thrust washers on both sides of the centre main bearing.

The main bearings have steel backs with bearing surfaces of tin aluminium. The main bearing caps are made of spheroidal graphite iron.

The front and the rear oil seals are Viton lip seals with oil return grooves on the inner face of the lip. The front seal is fitted in the front of the lubricating oil pump. For most engines, the rear oil seal is fitted directly into the flywheel housing or into the backplate. There are a few applications which have a separate housing fitted for the rear seal.

The nose of the crankshaft has two separate keyways. The rear keyway is for the key of the lubricating oil pump which is fitted around the crankshaft. The front keyway is for the toothed pulley which drives the timing belt.

The crankshaft pulley is fastened to the toothed pulley by four cap screws and is fastened to the crankshaft by a centre setscrew. The crankshaft pulley of marine engines and some industrial engines is held in position by a Ringfeder arrangement (14A.03/D). The pulleys which are currently fastened by this arrangement have four fastener holes for power take-off.

An integral damper is built into the pulley.

Some industrial engines have a brush type of dust seal fitted between the timing case cover and the pulley.

Crankshaft pulley

To remove and to fit (standard pulley) **14A-01A**

Special tool:
Anti-rotation tool, PD.203

- 1 Disconnect the battery.
- 2 Remove the drive belt of the alternator, operation 23A-03.
- 3 Remove the starter motor, operation 23B-01 and fit the anti-rotation tool (A1) to the flywheel.
- 4 Release and remove the four cap screws which fasten the pulley to the toothed pulley (B). Release the centre setscrew of the pulley and remove the pulley (C).
- 5 Clean the components and check for damage. Renew damaged components.
- 6 Put the pulley in position, fit the centre setscrew and tighten it finger tight. Fit the cap screws which fasten the pulley to the toothed pulley and tighten them finger tight. Tighten the centre setscrew to 180 Nm (133 lbf ft) 18,4 kgf m and then tighten the cap screws to 12 Nm (9 lbf ft) 1,2 kgf m.
- 7 Remove the anti-rotation tool and fit the starter motor, operation 23B-01.
- 8 Fit the drive belt of the alternator, operation 23A-03.
- 9 Connect the battery.

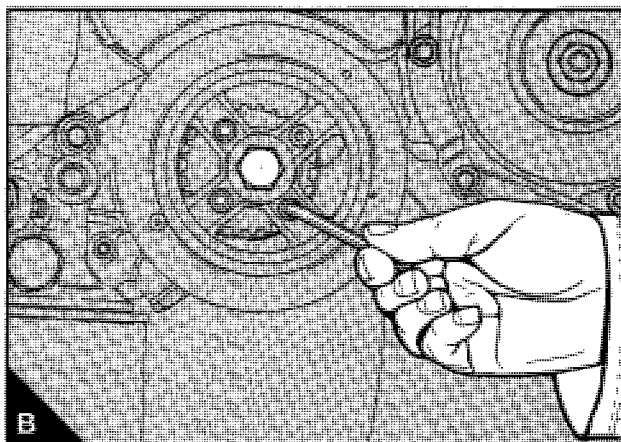
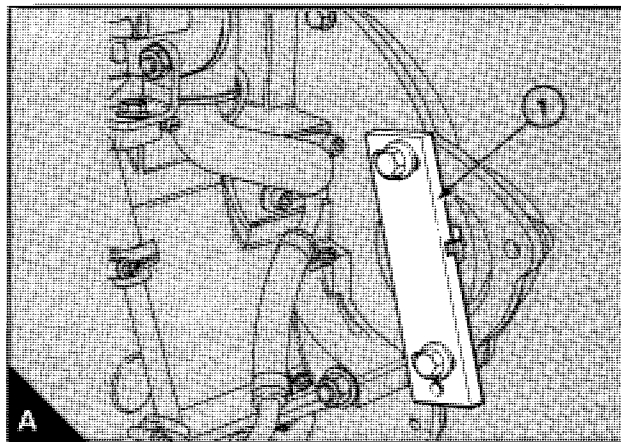

To remove and to fit (Ringfeder pulley) **14A-01B**

Special tool:
Anti-rotation tool, PD.203

Attention: Two types of Ringfeder arrangements (D) are used, according to the application. The components are not interchangeable between the two arrangements.

- 1 Disconnect the battery.
- 2 Remove the drive belt of the alternator, operation 23A-03.
- 3 Remove the starter motor, operation 23B-01 and fit the anti-rotation tool (A1) to the flywheel.
- 4 Release and remove the four cap screws which fasten the pulley to the toothed pulley (B). Release the centre setscrew of the pulley and remove the pulley (C). Remove the spacer (D2) and the inner and outer tapered rings (D1 and D3) from the pulley or the crankshaft. If necessary, remove the washer (D4).
- 5 Clean the components and check for damage. Renew damaged components. Do not use a degreasing solution on the Ringfeder components and do not open out the tapered rings.
- 6 Ensure that the toothed pulley for the timing belt is fully towards the rear. If necessary, fit the washer (D4) in the recess in the toothed pulley. Put the inner ring (D1) on the nose of the crankshaft with the narrow edge of the ring towards the front end of the crankshaft. Put the spacer (D2) inside the recess in the rear of the pulley. Put the outer ring (D3) on the spacer with the narrow edge of the ring towards the open end of the recess.
- 7 Ensure that the gap in the outer ring will not align with the gap in the inner ring when the pulley is fitted and put the pulley assembly into position on the crankshaft. Fit the centre setscrew and tighten it finger tight.
- 8 Engage the four cap screws which hold the toothed pulley to the crankshaft but do not tighten them.
- 9 Tighten the centre setscrew to the correct torque according to its colour. Tighten gold setscrews to 180 Nm (133 lbf ft) 18,4 kgf m or tighten black setscrews to 200 Nm (148 lbf ft) 2,4 kgf m. Then tighten the cap screws to 12 Nm (9 lbf ft) 1,2 kgf m for M6 cap screws or 27 Nm (20 lbf ft) 2,7 kgf m for M8 cap screws.
- 10 Remove the anti-rotation tool and fit the starter motor, operation 23B-01.
- 11 Fit the drive belt of the alternator, operation 23A-03.
- 12 Connect the battery.

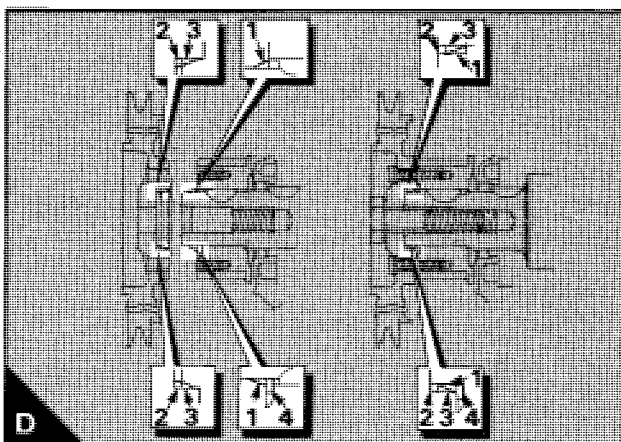
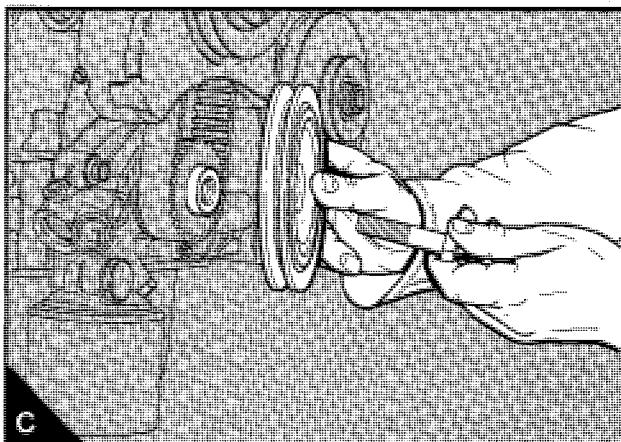

Front oil seal

To renew

14A-02

Special tools:

Remover tool for front oil seal, PD.192

Protection sleeve, PD.193

Replacer tool for front oil seal, PD.194

- 1 Disconnect the battery.
- 2 Remove the setscrew from the timing hole in the top front of the camshaft cover (12A.03/A4). Turn the crankshaft until the timing hole in the front journal of the camshaft aligns with the hole in the cover.
- 3 Fit the timing pins PD.182 to the camshaft and to the flywheel. Remove the starter motor, operation 23B-01 and fit the anti-rotation tool PD.203 to the flywheel.
- 4 If the water pump has a front inlet, drain the cooling system and disconnect the inlet pipe.
- 5 Remove the alternator drive belt, operation 23A-03 and the pulley of the water pump.
- 6 Remove the crankshaft pulley, operation 14A-01A or 14A-01B and remove the timing case cover, operation 15A-01.
- 7 Fit the location pins PD.190 to hold the pulley of the injection pump and remove the timing belt, operation 15A-04.
- 8 Remove the toothed pulley from the crankshaft, operation 15A-07.
- 9 Remove the front key from the crankshaft.
- 10 Fit the adaptor (A1) of tool PD.192 into the front of the crankshaft. Release the centre screw enough to ensure that it will not reach the adaptor and enter the main tool into the seal. Turn the tool clockwise to ensure that it is tight in the seal and tighten the screw onto the adaptor to remove the seal (B). Remove the adaptor.
- 11 Ensure that the seal location and the crankshaft are clean and that they are not damaged.
- 12 Fit the protection sleeve PD.193 (C1) to the crankshaft. Lubricate the new seal with clean engine lubricating oil. Enter the seal into its location over the protection sleeve with the lip of the seal towards the engine. Remove the protection sleeve. Use the replacer PD.194 (D1) with a soft face hammer to fit the seal into its final position. The correct position for the seal is with the front face of the seal 0,5 mm (0.02 in) inside the housing.
- 13 Fit the key to the crankshaft and fit the toothed pulley to the crankshaft, operation 15A-07. If a brush seal is not fitted to the timing case cover, fit the crankshaft pulley, operation 14A-01A or 14A-01B.
- 14 Fit the timing belt and adjust the belt tension, see section 15.
- 15 Remove the timing pins, the pulley pins and the anti-rotation tool. Check the timing of the fuel injection pump, operation 17A-03.
- 16 Turn the crankshaft through two revolutions to ensure that there is no restriction to movement.
- 17 Fit the timing case cover, operation 15A-01. If a brush seal is fitted to the cover, fit the crankshaft pulley, operation 14A-01A or 14A-01B.
- 18 Fit the pulley of the water pump and the alternator drive belt, operation 23A-03. If necessary, fit the fan, operation 21A-09.
- 19 If necessary, connect the inlet pipe of the water pump and fill the cooling system.
- 20 Fit the starter motor and connect the battery.

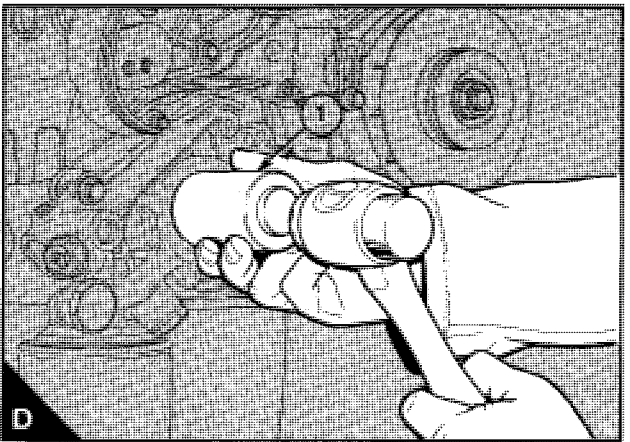
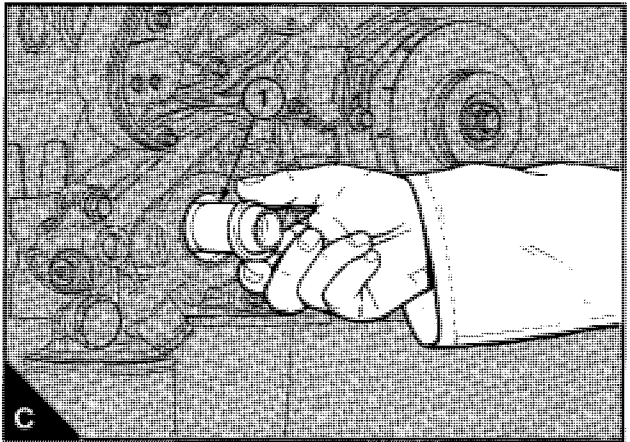
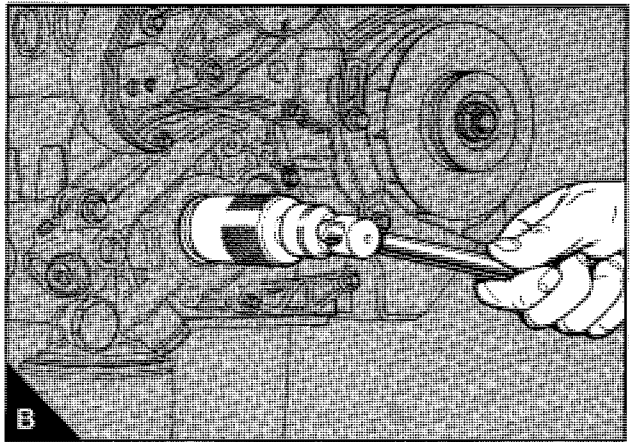
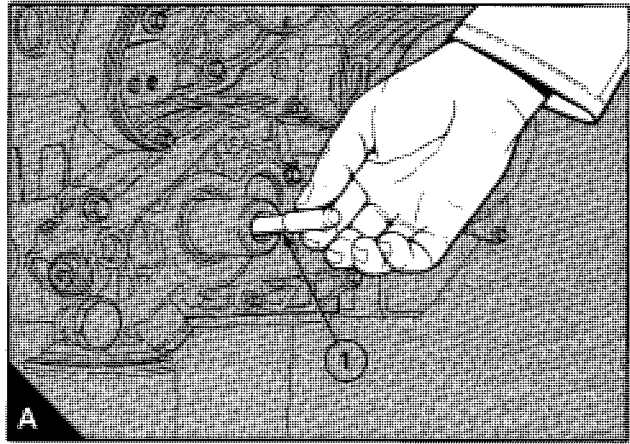

Rear oil seal

To renew

14A-03

Special tools:

Protection sleeve, PD.191

Remover tool for rear oil seal, PD.204

Replacer tool for rear oil seal, PD.205

- 1 Disconnect the battery.
- 2 Remove the drive components from the rear end of the engine.
- 3 Remove the flywheel, operation 22A-01.
- 4 Check the position of the seal in the flywheel housing, in the separate seal housing or in the backplate. If the rear face of the seal is level with the rear face of the housing, the new seal can probably be pressed further into its housing; this will move the seal location area on the crankshaft flange. This is not possible if a 10 mm (0.39 in) thick backplate is fitted. If the crankshaft flange is worn and a new seal position is not available, remove the crankshaft and machine the flange, see section 11C.
- 5 Release the screw (A1) of the remover tool enough to ensure that it will not touch the crankshaft. Enter the tool into the seal and turn it clockwise to ensure that it is tight in the seal. Use a spanner on the main body of the tool to ensure that the tool is tight in the seal. Tighten the screw onto the rear of the crankshaft to remove the seal.
- 6 Clean the seal housing and the crankshaft flange.
- 7 Lubricate lightly the seal housing, the crankshaft flange and the lip of the new seal with clean engine oil.
- 8 Clean and lubricate the protection sleeve PD.191 (B1) and fit it on the end of the crankshaft flange.
- 9 Put the seal (B2) over the sleeve with the lip towards the engine and push it along the flange until it enters the seal housing. Remove the protection sleeve.
- 10 Put the ring (C1) of tool PD.205 on the crankshaft flange with the correct end of the ring towards the seal. If the seal is to be fitted in the forward position (see paragraph 4), fit the sleeve with the end which has a reduced diameter towards the seal. Fit the plate (C2) of tool PD.205 and use the lock nuts to tighten the studs into the crankshaft flange. Release the lock nuts, ensure that the plate is fitted squarely to the crankshaft and use the forward nuts to press the seal into position. The nuts must be tightened gradually and evenly.
- 11 Remove the tools and fit the flywheel, operation 22A-01.
- 12 Fit the drive components to the rear end of the engine and connect the battery.

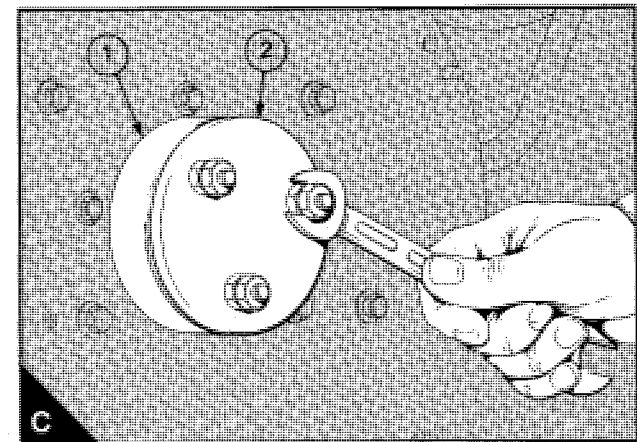
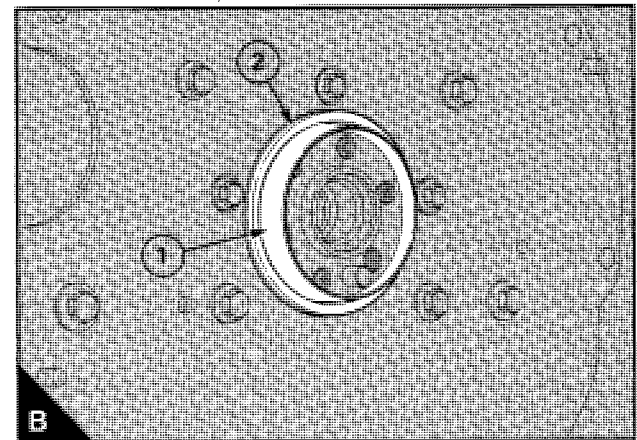
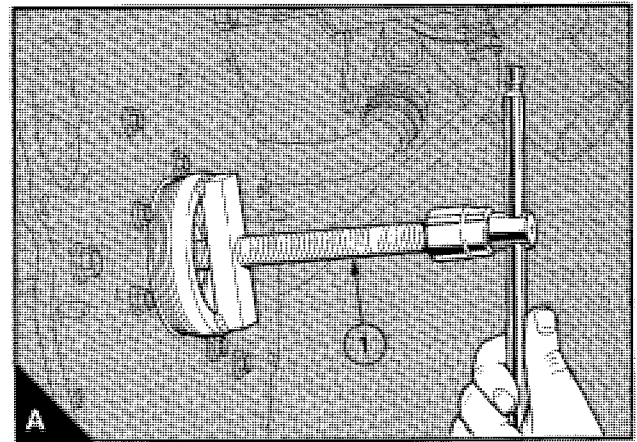

To remove and to fit the
separate oil seal housing

14A-04

Special tool:

Protection sleeve, PD.191

- 1 Disconnect the battery.
- 2 Remove the drive components from the rear end of the engine.
- 3 Remove the flywheel, operation 22A-01.
- 4 Remove the oil seal housing and the joint.
- 5 Clean the rear face of the cylinder block and of the rear main bearing and clean the front face of the seal housing. Inspect the seal for wear and for damage to the lip; renew the seal, if necessary. If there is only a small scratch across the lip, renew the seal. In the factory the seal is fitted with its rear face level with the rear face of the housing. In service, if the crankshaft is worn, the seal can be fitted with its front face level with the front face of the housing. Use a suitable adaptor to press out the old seal and to press in the new seal. Ensure that the seal is fitted squarely in the housing and that the lip will be towards the engine. The seal must be fitted before the housing is fitted to the engine because the seal will be used to ensure that the housing is fitted correctly.
- 6 Clean the crankshaft flange and lubricate lightly with clean engine lubricating oil.
- 7 Clean and lubricate the protection sleeve PD.191 (A1) and fit it on the end of the crankshaft flange.
- 8 Put a new joint in position (A2). Lubricate the seal and push the seal housing assembly over the protection sleeve and into position against the joint. Engage the housing setscrews.
- 9 Ensure that there is no distortion of the seal and tighten the setscrews gradually and evenly to the relevant torque given in section 11B. Ensure that the housing is not pressed off centre when the setscrews are tightened.

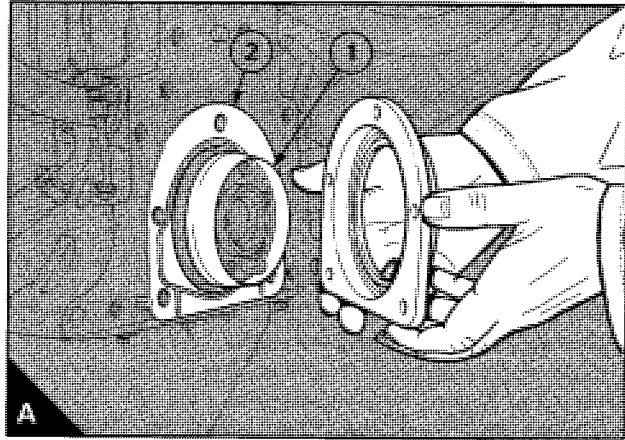

Thrust washers

To check crankshaft end-float

14A-05

The axial movement of the crankshaft is controlled by two half thrust washers fitted both sides of the centre main bearing (B). The end-float can be checked with a feeler gauge between a thrust washer and the crankshaft. A better method is to use a dial test indicator on one end of the crankshaft to check the movement (A).

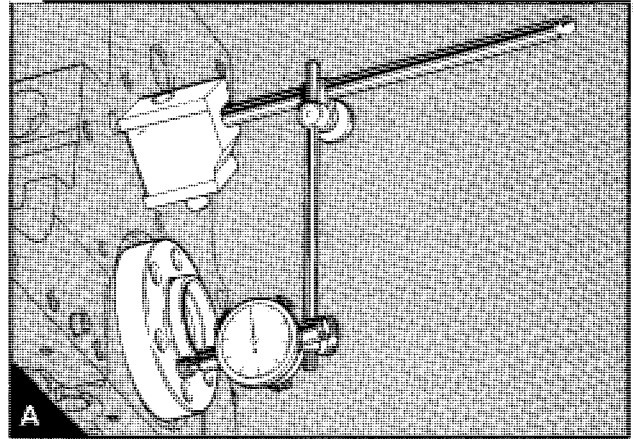

To remove and to fit

14A-06

To remove

- 1 Disconnect the battery.
- 2 Drain the lubricating oil and remove the lubricating oil sump, operation 19A-03.
- 3 Where necessary, remove the lubricating oil strainer and suction pipe, operation 19A-04.
- 4 Release the setscrews of the centre main bearing and remove the main bearing cap complete with the lower half thrust washers (B).
- 5 With a suitable tool made of a soft material, press down one end of each upper half thrust washer in order to slide the washer from its recess (C). Where necessary, move the crankshaft to the front or to the rear to loosen a tight washer.

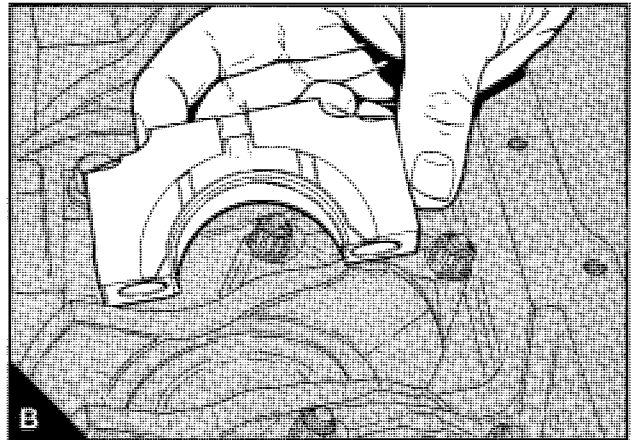

To fit

- 1 Lubricate the thrust washers with clean engine lubricating oil.
- 2 Slide the upper half thrust washers into their recesses in the cylinder block. Ensure that the sides of the thrust washers which have the grooves are against the crankshaft.
- 3 Fit the lower half thrust washers to the main bearing cap with the location tags in their recesses. Ensure that the grooves in the washers are away from the cap (B).
- 4 Ensure that the location thimbles are fitted correctly in the main bearing cap or in the cylinder block.
- 5 Ensure that the bearing is fitted correctly in the cap and that the bearing and the crankshaft journal are clean. Lubricate the bearing with clean engine lubricating oil.
- 6 Fit the cap with the location tags of both half bearings to the same side (14A.08/B1 and B2). Tighten the main bearing setscrews gradually and evenly to 112 Nm (83 lbf ft) 11,4 kgf m.
- 7 Check the crankshaft end-float.
- 8 If necessary, fit the lubricating oil strainer and the suction pipe, operation 19A-04.
- 9 Fit the lubricating oil sump, operation 19A-03, and fill it to the correct level with an approved lubricating oil.
- 10 Connect the battery.

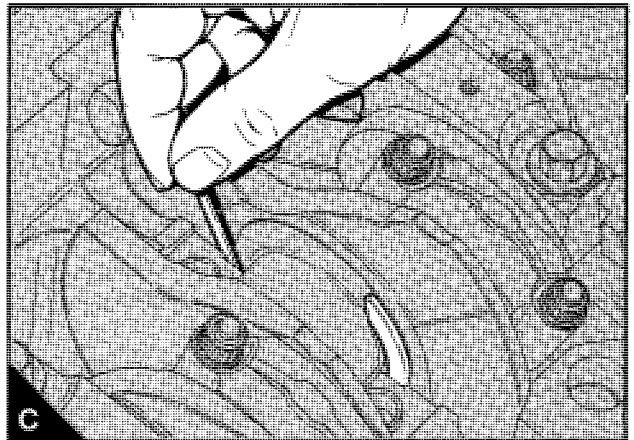

Main bearing

To remove and to fit
(with the crankshaft in position)

14A-07

If the front bearing is to be removed, the lubricating oil pump must also be removed. Removal of the bearing cap (with the pump in position) will damage the pump joint.

If the rear bearing cap is removed (with the backplate or the flywheel housing fitted), POWERPART Sealant (Loctite 518) must be applied to the bottom of the rear face of the bearing cap before it is fitted.

To remove

- 1 Drain the lubricating oil and remove the sump, operation 19A-03.
- 2 If necessary, remove the lubricating oil strainer and suction pipe, operation 19A-04.
- 3 Release the setscrews of the bearing cap and remove the bearing cap. Remove the lower half bearing from the cap.
- 4 With a suitable tool, push the upper half bearing from the side opposite to the location tag. This will remove the bearing tag from its recess in the bearing housing. Carefully rotate the crankshaft to release the bearing from its housing. Keep the bearing halves in their relevant positions.

To fit

- 1 Clean the upper half bearing and lubricate the bearing surface with clean engine lubricating oil.

Attention: Only the upper half bearing has lubrication holes and must be fitted to the cylinder block side. The bearings for the centre main journal are wider than the other bearings (A). The centre bearings also have the location tags in a different position.

- 2 Fit the plain end of the upper half bearing between the crankshaft journal and the side of the bearing housing which has the recess for the location tag. Slide the bearing into its housing until the tag on the bearing is fitted correctly in its recess in the housing (B1).

- 3 Clean the lower half bearing and the cap, lubricate the bearing surface with clean engine lubricating oil.

- 4 Fit the bearing into the cap with the tag of the bearing fitted correctly in the recess in the cap (B2).

- 5 Ensure that the location thimbles (B3) are fitted correctly to the cap or to the cylinder block. Fit the bearing cap with the location tags of both bearings on the same side.

- 6 Inspect the setscrews for damage and for distortion and renew them if necessary. Lightly lubricate the setscrew threads with clean engine lubricating oil. Fit the setscrews and the washers and tighten the setscrews gradually and evenly to 112 Nm (83 lbf ft) 11,4 kgf m.

- 7 Ensure that the crankshaft turns freely. If the thrust washers have been removed and fitted, check the crankshaft end-float, operation 14A-03.

- 8 If necessary, fit the lubricating oil strainer and suction pipe, operation 19A-04.

- 9 Fit the lubricating oil sump, operation 19A-03 and fill it to the correct level with an approved lubricating oil.

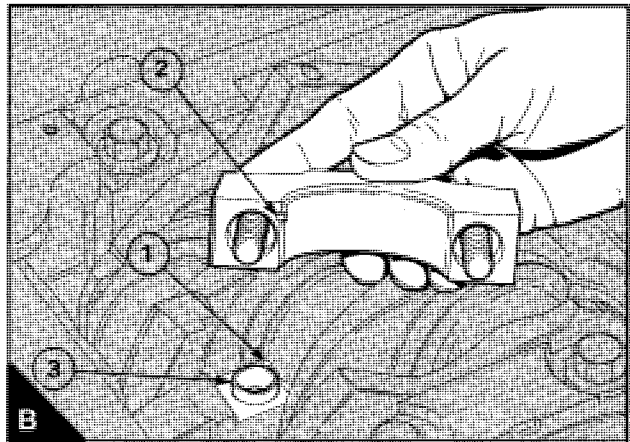
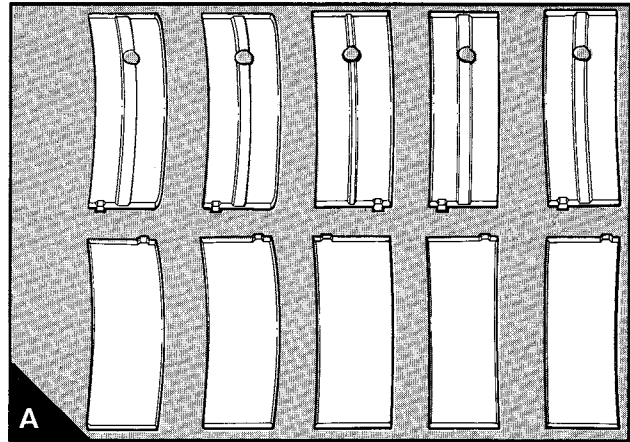

To inspect

14A-08

Inspect the bearings for wear and for other damage. If a bearing is worn or damaged, renew both half bearings and check the condition of the other bearings.

Crankshaft

To remove and to fit

14A-09

To remove

- 1 Before the engine is removed from the vehicle or from the machine, drain the lubricating oil and the coolant.
- 2 Remove the lubricating oil sump, operation 19A-03. Remove the lubricating oil suction pipe and strainer, operation 19A-04.
- 3 Remove the crankshaft pulley, operation 14A-01. If necessary, remove the fan drive pulleys and the fan drive assembly. Remove the water pump pulley.
- 4 Remove the timing case cover, operation 15A-01.
- 5 Remove the flywheel and the flywheel housing, section 22.
- 6 Turn the crankshaft until all the pistons are equally up their bores.
- 7 Make temporary alignment marks on the timing belt and on suitable teeth of the crankshaft pulley, the camshaft pulley and the fuel injection pump pulley. This is to ensure that the belt can be fitted again in the same position.
- 8 Remove the timing belt, the toothed pulleys and the timing case, section 15.
- 9 Remove the lubricating oil pump, operation 19A-06.
- 10 Measure the crankshaft end-float to check if new thrust washers are needed.
- 11 Ensure that all the connecting rod caps are marked with their relevant cylinder number. Remove the caps and the lower half big end bearings, operation 13A-01.
- 12 The inner main bearing caps are marked 2, 3 and 4 and also have the word "FRONT" to indicate the correct fitted position (A). Remove the main bearing caps, the lower half bearings and thrust washers and keep the bearings with their relevant caps. Slide out the upper half thrust washers.
- 13 Remove the crankshaft.
- 14 Remove the upper half main and big end bearings and keep them with their relevant caps.

To fit

- 1 Ensure that all lubricating oil passages are clean and free from restriction. Clean the sealant grooves in the sides of the front and the rear main bearing caps.
- 2 Clean the main bearing housings and the upper half bearings. Fit the bearings with the location tags fitted correctly in their recesses. The upper half main bearings have oil holes and grooves and the centre bearing is wider than the others. Lubricate the bearings with clean engine lubricating oil.
- 3 Ensure that the journals of the crankshaft are clean and lubricate them with clean engine lubricating oil. Carefully lower the crankshaft into position on the bearings.
- 4 Clean and lubricate the upper half thrust washers and slide them into their recesses on both sides of the bearing housing. Ensure that the lubrication grooves of the thrust washers are towards the crankshaft.
- 5 Clean the bearing caps and the lower half bearings. Fit the bearings to the caps with the location tags fitted correctly in their recesses. Lubricate the bearings with clean engine lubricating oil.
- 6 Ensure that the location thimbles for the main bearing caps are fitted correctly in the caps or in the cylinder block.

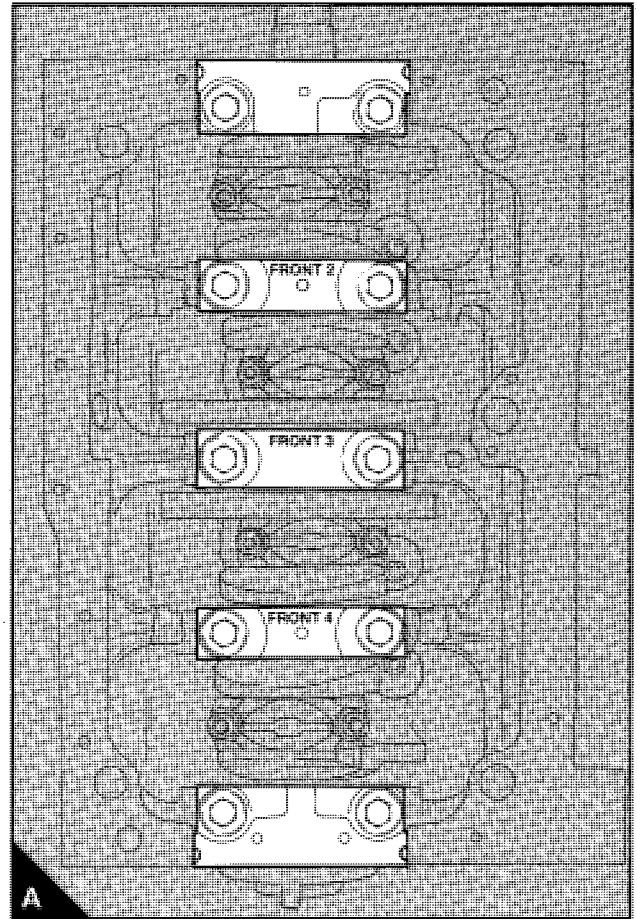

7 Clean the lower half thrust washers and lubricate them with clean engine lubricating oil. Fit the thrust washers to the centre main bearing cap with the oil grooves of the thrust washers away from the bearing. Ensure that the location thimbles for the cap are in position. Fit the cap to the cylinder block with the word "FRONT" to the timing case end of the block. Fit and tighten the cap setscrews gradually and evenly to 112 Nm (83 lbf ft) 11,4 kgf m.

8 Fit the remainder of the caps into their correct positions. Numbers 2 and 4 caps are stamped with their position number and the word "FRONT". The word "FRONT" must be towards the timing case end of the engine (14A.09/A). The front and rear caps are not stamped with a number; the front cap has a single threaded hole in its bottom face; the rear cap has two threaded holes in its bottom face. Fit and tighten the cap setscrews gradually and evenly to 112 Nm (83 lbf ft) 11,4 kgf m.

9 Check the crankshaft end-float and renew the thrust washers if necessary.

10 Remove the protection sleeves from the big end bolts.

11 Fit the connecting rod caps, see operation 13A-03.

12 Apply POWERPART Sealant (Loctite 518) where the front and rear main bearing caps meet the cylinder block (A). Fit the lubricating oil suction pipe, the sump and the oil pump, section 19.

13 Where necessary, fit the rear oil seal and housing, operation 14A-04.

14 Fit the flywheel housing or the backplate and fit the flywheel, see section 22.

15 Apply POWERPART Sealant (Loctite 518) where the front and rear main bearing caps meet the cylinder block (A) into the groove in each side of the front and the rear main bearing caps (B). Apply the sealant until it completely fills the grooves and also comes out of the gaps between the cap and the cylinder block. Remove sealant from around the fastener holes for the lubricating oil sump. Fit the sump, operation 19A-03, within five minutes of the sealant application.

16 Fit the timing case and the timing pulleys, see section 15. Fit the timing belt, operation 15A-04, with the temporary marks on the belt aligned with the marked teeth of the timing pulleys. Remove the temporary timing marks and adjust the belt tension, operation 15A-03.

17 Check the timing of the fuel injection pump, operation 17A-03.

18 Fit the timing case cover, operation 15A-01.

19 Fit the crankshaft pulley, operation 14A-01.

20 Fit the water pump pulley and, if necessary, fit the fan drive assembly, see section 21.

21 Fit the starter motor, operation 23B-01.

22 After the engine has been installed, fill the lubricating oil sump to the correct level with an approved oil. Fill the cooling system.

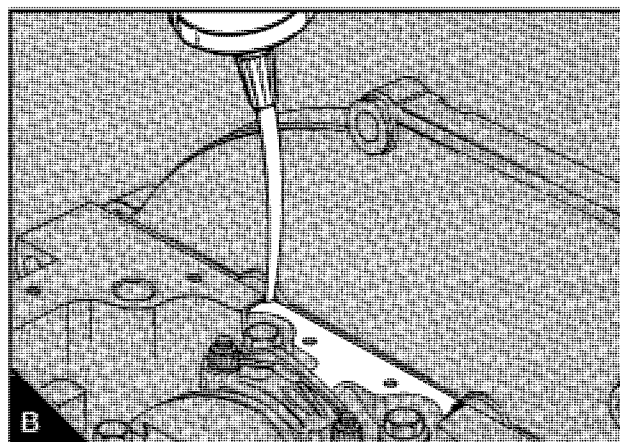
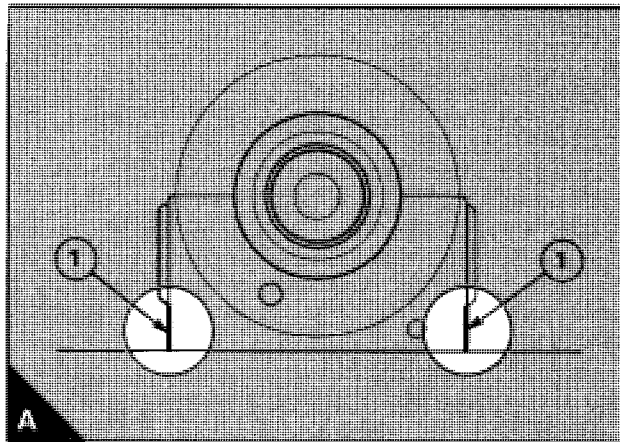

To inspect

14A-10

Check the crankshaft for wear and other damage. The maximum permissible wear and ovality on the crankshaft journals and on the crank pins is 0,03 mm (0.001 in).

The main journals and the crankpins of standard size crankshafts can be machined to 0,30 mm (0.012 in) undersize on diameter, see section 11C. Special undersize bearings are available.

The seal location area of the rear flange can be machined to remove the wear marks, if the seal has been used in both positions, see section 11C.

Timing case and drive assembly

15

	General description	15A.02
	Timing case cover	
15A-01	To remove and to fit	15A.03
	Timing belt	
15A-02	To check the belt condition and tension	15A.04
15A-03	To adjust the belt tension	15A.04
15A-04	To remove and to fit	15A.05
	Toothed pulley for fuel injection pump	
15A-05	To remove and to fit	15A.06
	Toothed pulley for camshaft	
15A-06	To remove and to fit	15A.07
	Toothed pulley for crankshaft	
15A-07	To remove and to fit	15A.08
	Timing case	
15A-08	To remove and to fit	15A.09

General description

Toothed pulleys are fitted to the camshaft (A1) and to the fuel injection pump (A2). These pulleys are driven through a toothed belt (A3) by a similar pulley fitted to the crankshaft (A4). The pulleys are made of sintered 2% copper iron and the belt is made of glass fibre and neoprene. A plain idler pulley (A5) ensures the correct belt engagement and an adjustable tensioner pulley (A6) controls the belt tension.

Currently, the camshaft pulley has a separate hub but, on some early engines, the pulley has an integral hub. The pulley of the fuel injection pump has two keyways, one for turbocharged engines and the other for naturally aspirated engines.

The timing pulleys and belt are contained in a timing case and cover which are made of glass filled polypropylene. A brush type of dust seal is fitted to the cover for certain industrial applications.

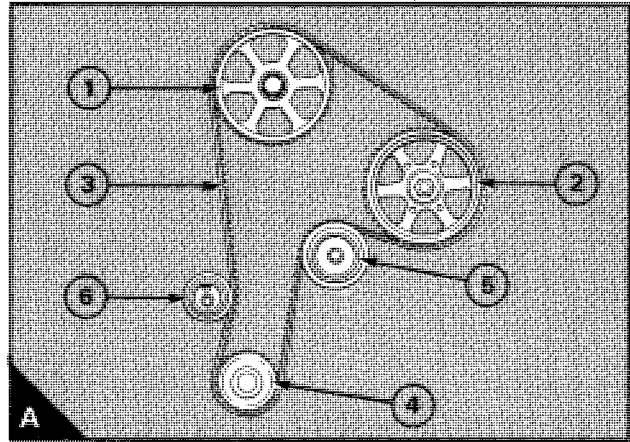

Timing case cover

To remove and to fit

15A-01

To remove

- 1 Disconnect the battery.
- 2 If fitted, remove the fan, operation 21A-09.
- 3 For applications with a high level fan, remove the fan drive assembly, operation 21A-10.
- 4 Remove the alternator drive belt, operation 23A-03.
- 5 Remove the pulley of the water pump.
- 6 If a dust seal is fitted, remove the crankshaft pulley, operation 14A-01A or 14A-01B.
- 7 Remove the access panel from the timing case (15A.04/A).
- 8 The timing case cover of later vehicle engines is in two parts (A). Ensure that the screw (A1) is removed before the upper part is removed (B). Ensure that the setscrew (A2) and screws (A3) are removed before the lower part is removed.
- 9 If the water pump has a front inlet and the timing case cover is in one piece, drain the coolant and disconnect the inlet pipe.
- 10 Release the clips of the cover and remove the cover (C).

To fit

- 1 Ensure that the cover is clean and that all the spring clips are fastened to the timing case.
- 2 If a brush dust seal is fitted to the cover, ensure that it is not damaged. If a new seal is to be fitted, slide it into the groove in the cover and ensure that the ends of the seal fit each side of the location in the cover (D1).
- 3 Fit the cover on to the timing case and ensure that all the fastener clips are pressed into position. With two piece timing covers for later vehicle engines, fit the bottom part and fasten it with the setscrew (A2), the screws (A3) and the spring clips. Fit the top part with the bottom edge of the cover between the front lugs (A4) and the rear lug of the bottom part of the cover. Fasten the top part with the screw (A1) and the spring clips.
- 4 Fit the access panel to the timing case and to the cover.
- 5 If necessary, fit the crankshaft pulley, operation 14A-01.
- 6 Fit the water pump pulley.
- 7 Fit the alternator drive belt, operation 23A-03.
- 8 For applications with a high level fan, fit the fan drive assembly, operation 21A-10.
- 9 If necessary, fit the fan, operation 21A-09.
- 10 If necessary, connect the inlet pipe of the water pump and fill the cooling system.
- 11 Connect the battery.

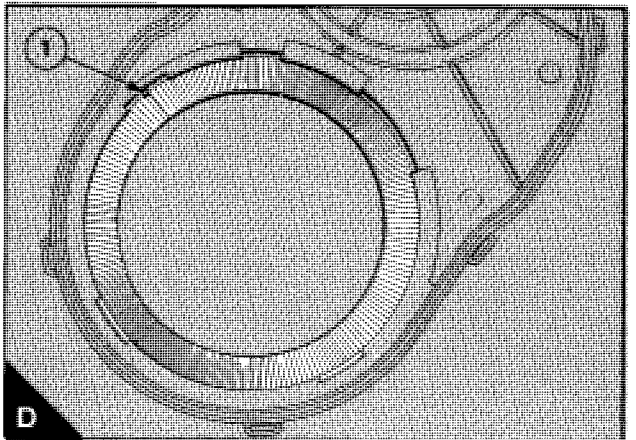
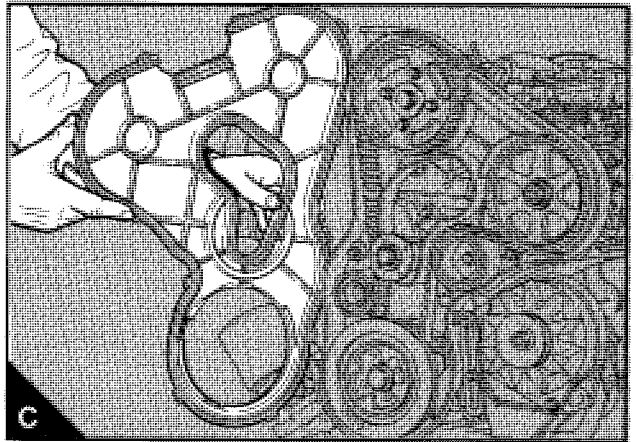
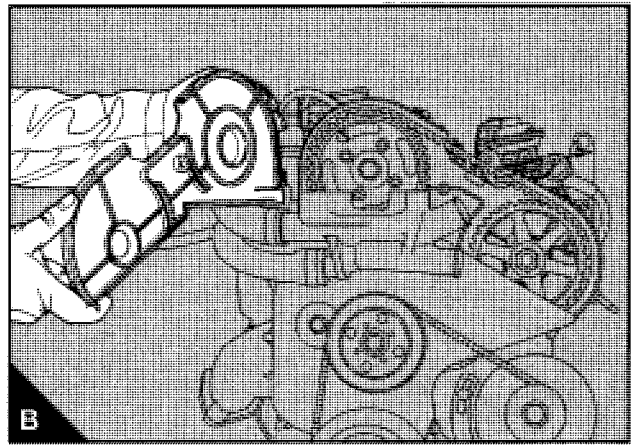
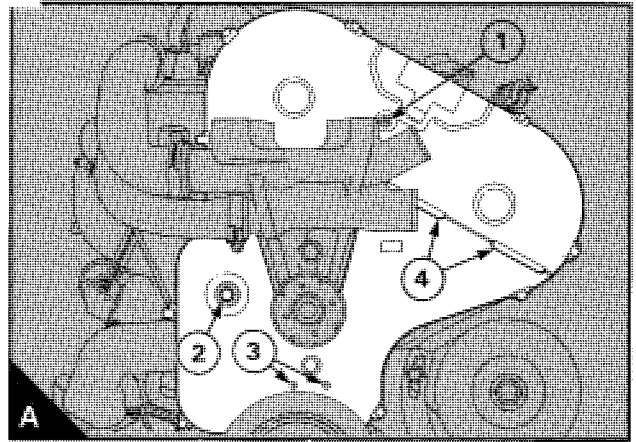

Timing belt

To check the belt condition and tension **15A-02**

Special tool:

Tension gauge, KM.4088P

- 1 Remove the access panel from the top of the timing case (A).
- 2 Make a temporary mark on the belt to ensure that the complete belt will be checked. Check the teeth for wear and damage and check the belt for cracks and oil contamination. Turn the crankshaft to check all the teeth and the complete belt. If necessary, renew the belt, operation 15A-04. Remove the temporary mark.
- 3 Press down the ball end of the tension gauge and fit the gauge over the belt. Ensure that the foot of the gauge is under the belt and between two of the belt teeth (B). Release the ball end slowly and check the gauge reading. Move the crankshaft by a small amount in each direction until a constant reading is obtained. The correct reading for a new belt is 95/105 lbf and for a used belt the correct reading is 80 lbf. If the tension of a used belt has reduced to 60 lbf or below, adjust the tension to 80 lbf, operation 15A-03.
- 4 When the tension is correct, fit the access panel to the timing case.

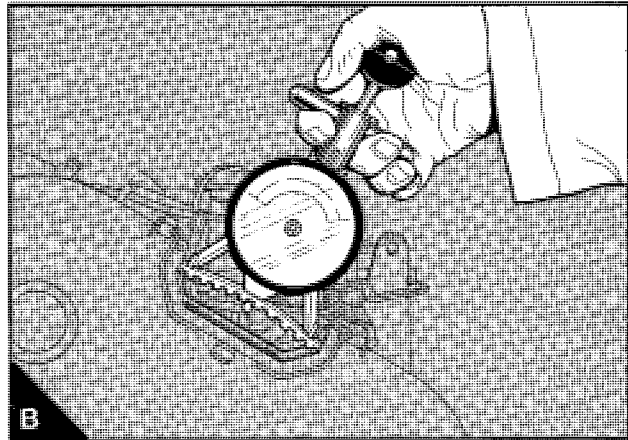
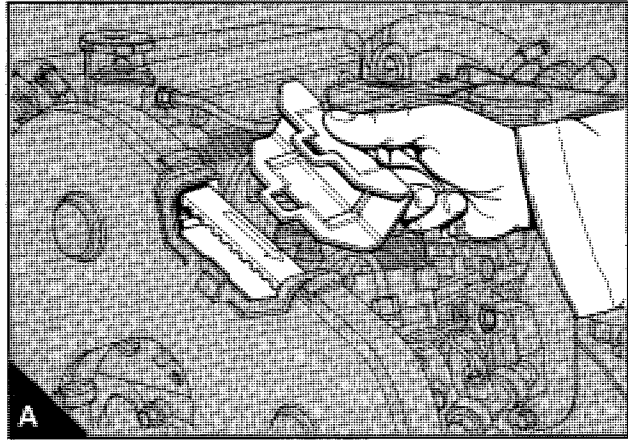

To adjust the belt tension **15A-03**

Special tools:

Timing pins, PD.182

Tension gauge, KM.4088P

- 1 Fit the timing pins to the camshaft and to the flywheel, operation 17A-01.
- 2 Remove the timing case cover, operation 15A-01.
- 3 Fit the tension gauge between the pulleys of the fuel injection pump and the camshaft.
- 4 Release the four setscrews of the camshaft pulley to allow the pulley to turn on its hub. For some early engines, the camshaft pulley is in one piece and the centre setscrew will need to be loosened.
- 5 Loosen the capscrew which fastens the belt tensioner pulley. Adjust the belt tension with an allen key fitted in the hexagonal adjustment hole in the pulley (C). The correct tension for a new belt is 100 lbf and the correct tension for a used belt is 80 lbf. When the tension is correct, tighten the capscrew to 43 Nm (32 lbf ft) 4,4 kgf m and check the tension again.
- 6 Tighten the setscrew(s) of the camshaft pulley to the correct torque, see section 11B and ensure that the tension is still correct.
- 7 **Remove the timing pins from the camshaft and from the flywheel.**
- 8 Turn the crankshaft through two revolutions and check the tension again.
- 9 Check the timing of the fuel injection pump, operation 17A-03.
- 10 Fit the cover to the timing case, operation 15A-01.

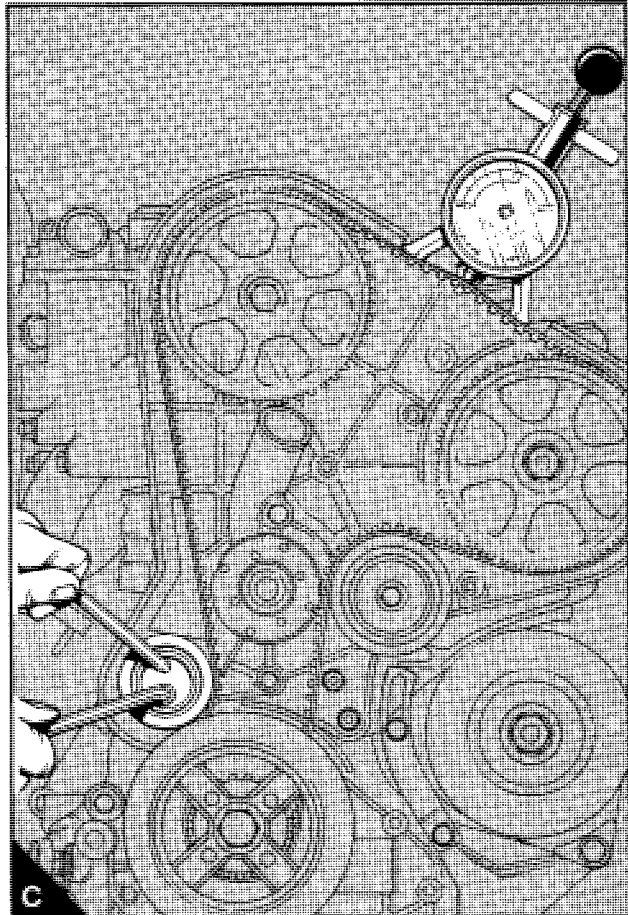

To remove and to fit**15A-04****Special tools:**

Timing pins, PD.182

Location pins for fuel pump pulley, PD.190

Anti-rotation tool, PD.203

To remove

- 1 Disconnect the battery.
- 2 Remove the setscrew from the timing hole in the camshaft cover. Turn the crankshaft until the timing hole in the camshaft aligns with the hole in the cover. Fit the timing pins PD.182 into the camshaft and into the flywheel.
- 3 Remove the starter motor and fit the anti-rotation tool PD.203 to the flywheel.
- 4 Remove the timing case cover, operation 15A-01.
- 5 Fit the location pins PD.190 (A1) through the plain holes in the pulley of the fuel injection pump and into the pump support bracket.
- 6 Remove the belt tensioner pulley and the idler pulley.
- 7 Remove the timing belt. Do not bend the belt to an acute angle as this can damage the belt and cause failure. Put the belt on its edge in a circle on a flat surface. Do not hang it.
- 8 Inspect the teeth of the belt for wear. Check the complete belt for oil contamination, cracks and other damage. Renew the belt if a fault is found.

To fit

- 1 Fit the timing belt over the toothed pulleys of the crankshaft, the camshaft and the fuel injection pump. Ensure that the direction arrows on the belt indicate a clockwise direction from the front (15A.04/A).
- 2 Fit the idler pulley and tighten the pulley setscrew to 43 Nm (32 lbf ft) 4,4 kgf m.
- 3 Put the tensioner pulley in position and engage the pulley capscrew. There are two threaded holes for the capscrew and it must be fitted in the hole which will allow correct adjustment of the belt tension. Tighten the capscrew to hold the pulley but do not tighten it fully.
- 4 Remove the location pins from the toothed pulley of the fuel injection pump and adjust the belt tension, operation 15A-03.
- 5 Tighten the setscrew(s) of the camshaft pulley to the correct torque, see section 11B and remove the anti-rotation tool.
- 6 **Remove the timing pins from the camshaft and from the flywheel.**
- 7 Check the timing of the fuel injection pump, operation 17A-03.
- 8 Turn the crankshaft through two revolutions to check that there is no restriction to movement.
- 9 Fit the timing case cover, operation 15A-01 and fit the access panel.
- 10 Fit the setscrew in the timing hole in the camshaft cover.
- 11 Fit the starter motor, operation 23B-01.
- 12 Connect the battery.

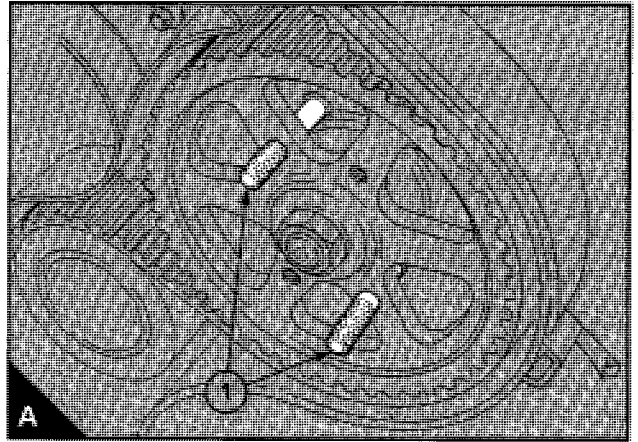

Toothed pulley for fuel injection pump

To remove and to fit

15A-05

Special tools:

Timing pins, PD.182
 Location pins for fuel pump pulley, PD.190
 Pulley remover, PD.195
 Adaptors for use with PD.195, PD.195-1
 Anti-rotation tool, PD.203

To remove

- 1 Disconnect the battery.
- 2 Remove the setscrew from the timing hole in the camshaft cover. Turn the crankshaft until the timing hole in the camshaft aligns with the hole in the cover and fit the timing pins PD.182 into the camshaft and into the flywheel.
- 3 Remove the starter motor and fit the anti-rotation tool PD.203 to the flywheel.
- 4 Remove the timing case cover, operation 15A-01.
- 5 Release and remove the pulley nut of the fuel injection pump. Loosen the setscrew(s) of the camshaft pulley.
- 6 Remove the timing belt, operation 15A-04.
- 7 Remove the pulley with the pulley remover PD.195 and adaptors PD.195-1 (A). Ensure that the key is not lost.
- 8 Check the pulley for wear, cracks and other damage. Renew it if necessary.

To fit

- 1 Ensure that the key is correctly fitted in the shaft of the fuel injection pump.
- 2 Put the pulley in position on the shaft with the correct keyway in engagement with the key. There are two keyways and two marked teeth "A" and "B" on the pulley. Use the relevant keyway and marked tooth according to the plunger lift of the fuel injection pump when the engine piston is at TDC (see page 11C.09).
 Where the plunger lift is 1.26 mm and above, use the keyway which is on the same side as the tooth marked "A" (B1). Where the plunger lift is below 1,26 mm, use the keyway which is on the same side as the tooth marked "B" (B2). Ensure that the marks on the pulley are towards the front of the engine.
- 3 Fit the spring washer and the pulley nut, hold the pulley to prevent movement and tighten the nut to press the pulley into position.
- 4 Ensure that the relevant marked tooth (see paragraph 2) of the pulley is near to the arrow on the timing case (A3). Fit the location pins PD.190 through the plain holes in the pulley and into the pump support bracket.
- 5 Fit the timing belt, operation 15A-04. Remove the pulley location pins and adjust the belt tension, operation 15A-03.
- 6 Tighten the pump pulley nut to 60 Nm (44 lbf ft) 6,1 kgf m and remove the anti-rotation tool.
- 7 **Remove the timing pins from the camshaft and from the flywheel.**
- 8 Check the timing of the fuel injection pump, operation 17A-03.
- 9 Turn the crankshaft through two revolutions to check that there is no restriction to movement.
- 10 Fit the timing case cover, operation 15A-01 and fit the access panel.
- 11 Fit the setscrew in the timing hole in the camshaft cover.
- 12 Fit the starter motor, operation 23B-01.
- 13 Connect the battery.

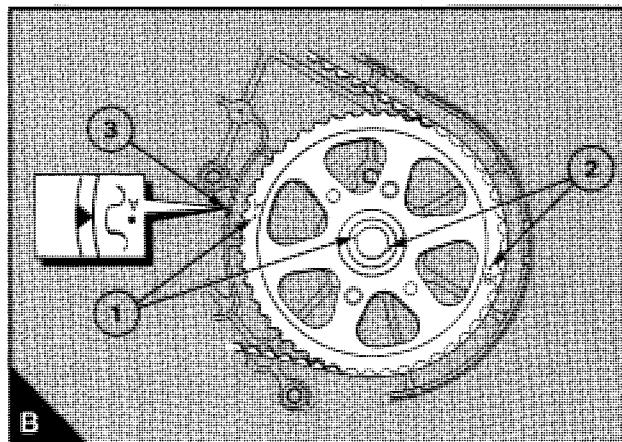
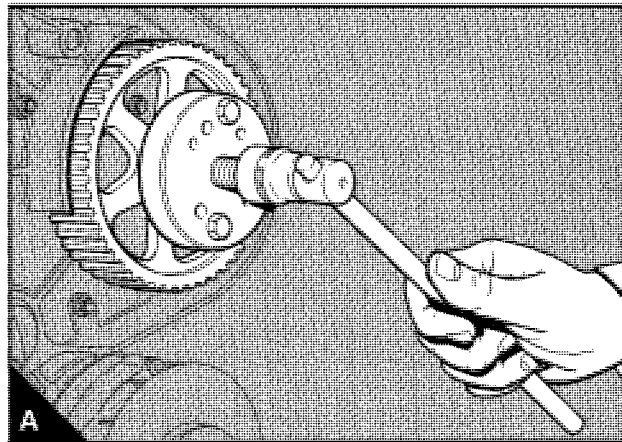

Toothed pulley for camshaft

To remove and to fit

15A-06

Special tools:

Timing pins, PD.182

Location pins for fuel pump pulley, PD.190

Pulley remover, PD.195

Adaptors for use with PD.195, PD.195-1

Anti-rotation tool, PD.203

To remove

- 1 Disconnect the battery.
- 2 Remove the setscrew from the timing hole in the camshaft cover. Turn the crankshaft until the timing hole in the camshaft aligns with the hole in the cover. Fit the timing pins PD.182 into the camshaft and into the flywheel.
- 3 Remove the starter motor and fit the anti-rotation tool PD.203 to the flywheel.
- 4 Remove the timing case cover, operation 15A-01.
- 5 Fit the location pins PD.190 through the plain holes in the pulley of the fuel injection pump and into the pump support bracket.
- 6 If the hub of the two piece pulley for the camshaft is to be removed (or if a one piece pulley is fitted) loosen the centre setscrew. Loosen the setscrews which fasten the two piece pulley to the hub.
- 7 Remove the timing belt, operation 15A-04.
- 8 Remove the pulley setscrew(s) and remove the pulley (A or B). If necessary, remove the pulley hub (C1) and its dowel (C2).
- 9 Check the pulley for wear, cracks and other damage. Renew it if necessary.

To fit

- 1 If a single piece pulley is used, fit the pulley and the setscrew to the camshaft but do not fully tighten the setscrew.
If a two piece pulley is used and the hub (C1) has been removed, ensure that the dowel (C2) is in position in the camshaft. Fit the hub and its setscrew but do not fully tighten the setscrew. If necessary, fit the pulley to the hub but do not fully tighten the setscrews.
- 2 Fit the timing belt, operation 15A-04. Remove the location pins from the pulley of the injection pump and adjust the belt tension, operation 15A-03.
- 3 Tighten the centre setscrew of the pulley to 85 Nm (63 lbf ft) 8,7 kgf m and/or tighten the setscrews which fasten the pulley to the hub to 22 Nm (16 lbf ft) 2,2 kgf m. Remove the anti-rotation tool.
- 4 **Remove the timing pins from the camshaft and from the flywheel.**
- 5 Check the timing of the fuel injection pump, operation 17A-03.
- 6 Turn the crankshaft through two revolutions to check that there is no restriction to movement.
- 7 Fit the timing case cover, operation 15A-01 and fit the access panel.
- 8 Fit the setscrew in the timing hole in the camshaft cover.
- 9 Fit the starter motor, operation 23B-01.
- 10 Connect the battery.

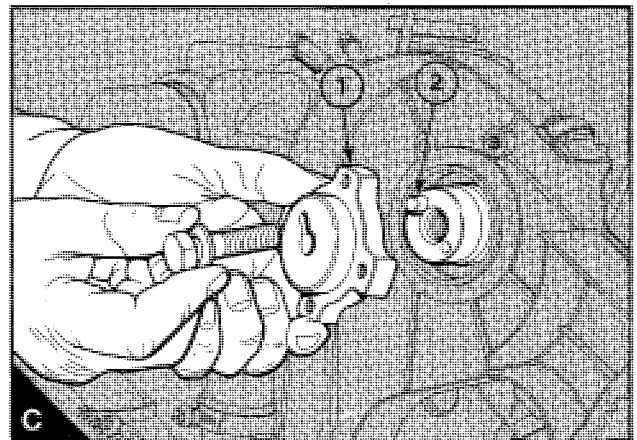
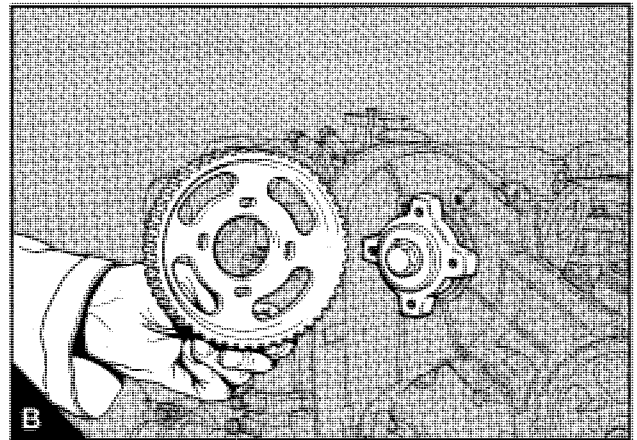
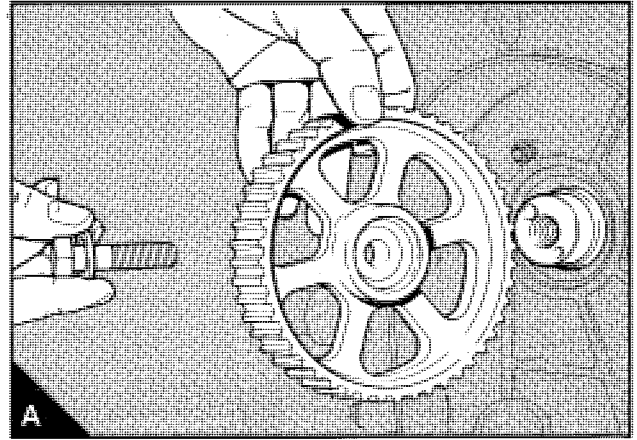

Toothed pulley for crankshaft

To remove and to fit

15A-07

Special tools:

Timing pins, PD.182
Location pins for fuel pump pulley, PD.190
Pulley remover, PD.195
Adaptors for use with PD.195, PD.195-1
Anti-rotation tool, PD.203

To remove

- 1 Disconnect the battery.
- 2 Remove the setscrew from the timing hole in the camshaft cover. Turn the crankshaft until the timing hole in the camshaft aligns with the hole in the cover. Fit the timing pins PD.182 into the camshaft and into the flywheel.
- 3 Remove the starter motor and fit the anti-rotation tool PD.203 to the flywheel.
- 4 Remove the crankshaft pulley, operation 14A-01A or 14A-01B.
- 5 Remove the timing case cover, operation 15A-01.
- 6 Fit the location pins PD.190 through the plain holes in the pulley of the fuel injection pump and into the pump support bracket.
- 7 Remove the timing belt, operation 15A-04.
- 8 Remove the toothed pulley from the crankshaft. If it is tight, use remover tool PD.195 and adaptors PD.195-1. Fit the narrow end of the distance piece (A1) into the crankshaft. Fasten the main tool (B) to the pulley with the setscrews and tighten the centre screw onto the distance piece to remove the pulley.
- 9 Check the pulley for wear, cracks and other damage. Renew it if necessary.

To fit

- 1 Ensure that the key is fitted correctly to the crankshaft. Put the toothed pulley in position on the crankshaft with the tapped holes towards the front. If a brush type of dust seal is not fitted to the timing case cover, fit the crankshaft pulley, operation 14A-01A or 14A-01B.
- 2 Fit the timing belt, operation 15A-04. Remove the location pins from the pulley of the injection pump and adjust the belt tension, operation 15A-03. Remove the anti-rotation tool.
- 3 **Remove the timing pins from the camshaft and from the flywheel.**
- 4 Check the timing of the fuel injection pump, operation 17A-03.
- 5 Turn the crankshaft through two revolutions to check that there is no restriction to movement.
- 6 Fit the timing case cover, operation 15A-01 and fit the access panel. If a brush type of dust seal is fitted to the cover, fit the crankshaft pulley, operation 14A-01A or 14A-01B.
- 7 Fit the setscrew in the timing hole in the camshaft cover.
- 8 Fit the starter motor, operation 23B-01.
- 9 Connect the battery.

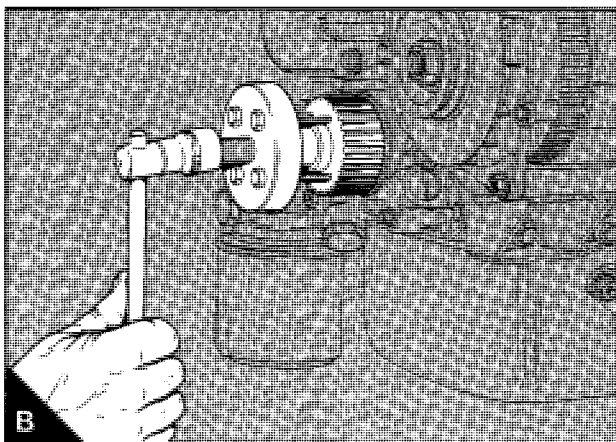
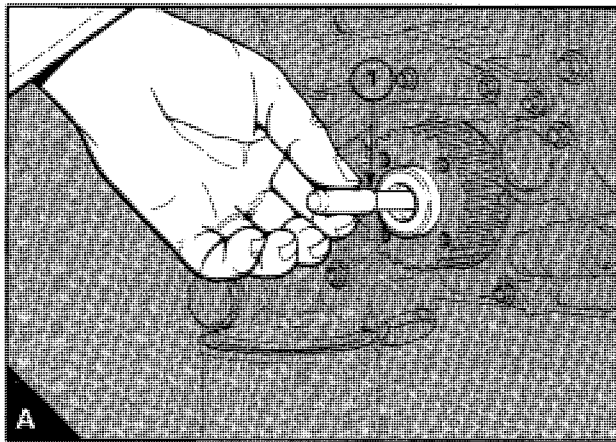

Timing case

To remove and to fit

15A-08

Special tools:

Timing pins, PD.182

Location pins for fuel pump pulley, PD.190

Pulley remover, PD.195

Adaptors for use with PD.195, PD.195-1

Anti-rotation tool, PD.203

To remove

- 1 Disconnect the battery.
- 2 Remove the setscrew from the timing hole in the camshaft cover. Turn the crankshaft until the timing hole in the camshaft aligns with the hole in the cover. Fit the timing pins PD.182 into the camshaft and into the flywheel.
- 3 Remove the starter motor and fit the anti-rotation tool PD.203 to the flywheel.
- 4 Remove the crankshaft pulley, operation 14A-01A or 14A-01B. This is not necessary for some vehicle engines.
- 5 Remove the timing case cover, operation 15A-01.
- 6 Fit the location pins PD.190 through the plain holes in the pulley of the fuel injection pump and into the pump support bracket.
- 7 Remove the timing belt, operation 15A-04.
- 8 Remove the toothed pulleys from the fuel injection pump, operation 15A-05 and from the camshaft, operation 15A-06.
- 9 Release the setscrews which fasten the timing case to the cylinder head, the cylinder block, the support bracket for the fuel injection pump and the lubricating oil pump. On some vehicle engines, remove the setscrew which fastens the timing case to the water pump (21A.05/A2). Remove the timing case (A).

10 Check the timing case for cracks and other damage and renew the timing case, if necessary. Ensure that all the fastener clips are fitted correctly to the timing case (B1). The timing cases of some industrial engines have dust seals fitted (B2). These seals can be renewed, if necessary. The new seals have adhesive already applied to one face. Ensure that the seal for the inspection cover does not protrude past the front edge of the cover.

To fit

- 1 Ensure that the location faces of the engine and of the timing case are clean. Put the cover in position and fasten it with the setscrews. Tighten the setscrews to the correct torque according to the thread size, see section 11B.
- 2 Fit the toothed pulleys to the fuel injection pump, operation 15A-05 and to the camshaft, operation 15A-06.
- 3 If necessary, fit the crankshaft pulley, operation 14A-01A or 14A-01B. If a dust seal is fitted to the timing case cover, fit the pulley after the timing case cover is fitted.
- 4 Fit the timing belt, operation 15A-04. Remove the location pins from the pulley of the injection pump and adjust the belt tension, operation 15A-03. Remove the anti-rotation tool.
- 5 **Remove the timing pins from the camshaft and from the flywheel.**
- 6 Check the timing of the fuel injection pump, operation 17A-03.
- 7 Turn the crankshaft through two revolutions to check that there is no restriction to movement.
- 8 Fit the timing case cover, operation 15A-01 and fit the access panel. If a brush type of dust seal is fitted to the cover, fit the crankshaft pulley, operation 14A-01A or 14A-01B.
- 9 Fit the setscrew in the timing hole in the camshaft cover.
- 10 Fit the starter motor, operation 23B-01.
- 11 Connect the battery.

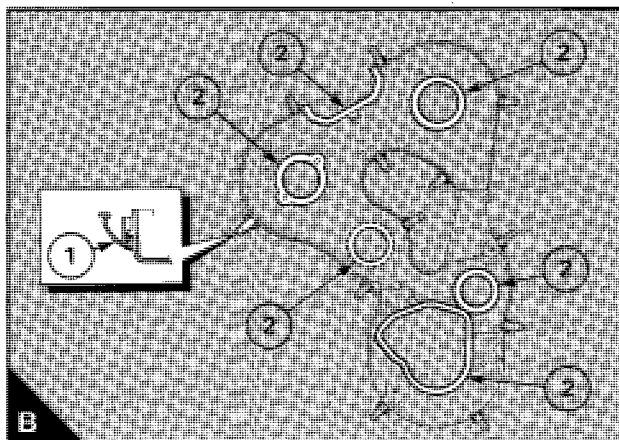
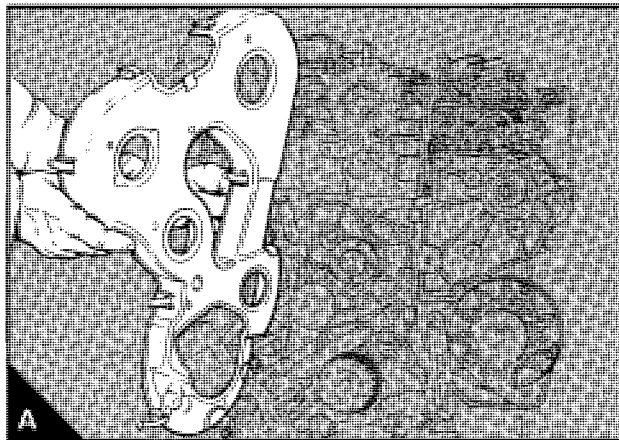

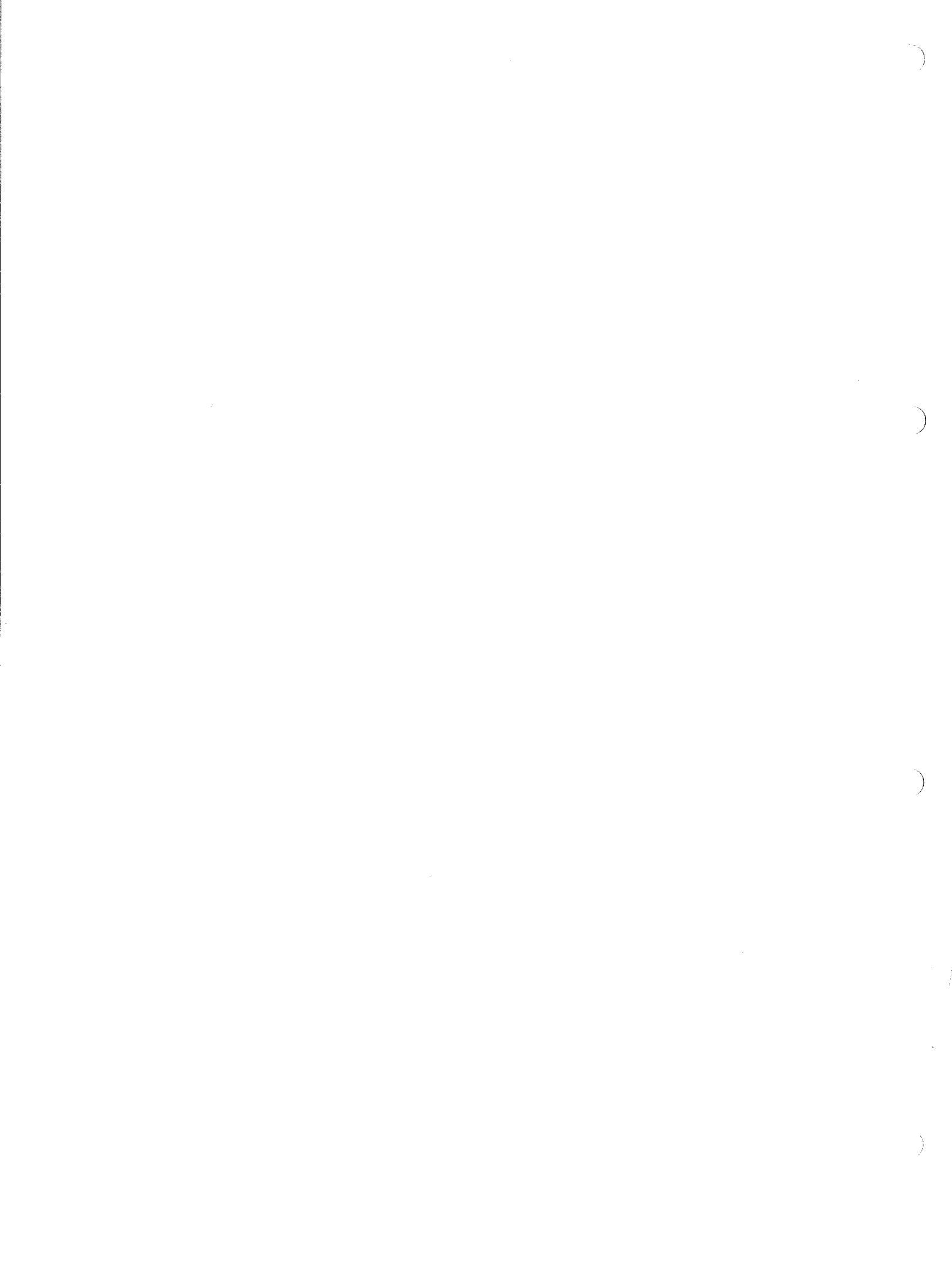

Cylinder block assembly

16

	General description	16A.02
	Cylinder block																		
16A-01	To dismantle and to assemble	16A.03
16A-02	To inspect	16A.04
16A-03	To correct a glazed bore	16A.04

General description

The cylinder block is made of cast iron with sides which extend below the crankshaft for maximum support. The cylinder bores are machined directly into the block and are specially honed to reduce wear and oil consumption.

Cylinder block

To dismantle and to assemble

16A-01

To dismantle

- 1 Drain the cooling system and the lubricating oil. For marine engines, see section 21.
- 2 Remove the engine from the application.
- 3 Remove the alternator drive belt and the alternator and its mounting bracket, see section 23.
- 4 If necessary, remove the fan and the fan drive, see section 21.
- 5 Remove the starter motor, operation 23B-01 and fit the anti-rotation tool to the flywheel.
- 6 Remove the crankshaft pulley, operation 14A-01A or 14A-01B.
- 7 Remove the timing case cover, the timing belt, the toothed pulleys and the timing case, see section 15. Remove the anti-rotation tool.
- 8 Remove the lubricating oil pump and filter assembly, operation 19A-06.
- 9 Remove the fuel filter, the atomisers and the fuel injection pump, see section 20.
- 10 If necessary, remove the turbocharger and its lubricating oil supply and drain pipes, see section 18.
- 11 Remove the reverse gearbox of marine engines.
- 12 Remove the flywheel and the flywheel housing or backplate, see section 22. For marine engines, remove the gearbox adaptor housing, the flywheel and the backplate.
- 13 Remove the cylinder head assembly, operation 12A-07.
- 14 Remove the lubricating oil cooler, where fitted, operation 21A-11.
- 15 Remove the oil filler/separator assembly.
Marine engines: Remove the oil drain pump and its bracket.
- 16 Remove the lubricating oil sump, operation 19A-03.
- 17 Remove the piston and connecting rod assemblies, operation 13A-03.
- 18 If necessary, remove the rear oil seal assembly, operation 14A-04. Remove the crankshaft, operation 14A.09.
- 19 Remove the mounting bracket for the fuel injection pump (A).
- 20 Remove the piston cooling jets, operation 13A-09, or the setscrews and washers, if cooling jets are not fitted.

To assemble

- 1 Clean thoroughly the new cylinder block. Ensure that all the oil passages are clean and free from debris. Ensure that the plug is fitted in the rear end of the pressure rail.
- 2 If necessary, fit the piston cooling jets, operation 13A-09. If jets are not used, fit the setscrews and the washers to close the oil holes and tighten the setscrews to 22 Nm (16 lbf ft) 2,2 kgf m.
- 3 Fit the bracket for the fuel injection pump. Ensure that the dowels (A1) are correctly fitted. Tighten the setscrews to 43 Nm (32 lbf ft) 4,4 kgf m.
- 4 Fit the crankshaft and, if necessary, the separate oil seal housing, see section 14.
- 5 Fit the piston and connecting rod assemblies, operation 13A-03.
- 6 Fit the lubricating oil sump, operation 19A-03.
- 7 Fit the oil filler/separator assembly.
Marine engines: Fit the oil drain pump and its bracket.
- 8 Fit the flywheel housing or backplate and the flywheel, see section 22.
Marine engines: Fit the backplate, the flywheel and the gearbox adaptor housing.

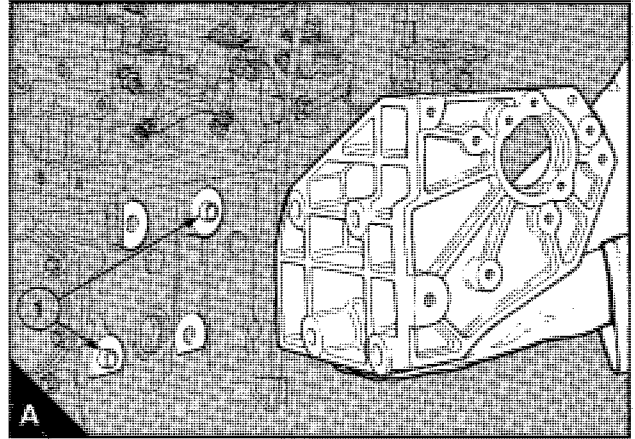

- 9 If necessary, fit the lubricating oil cooler, operation 21A-11.
- 10 Fit the cylinder head assembly, operation 12A-07.
- 11 Fit the fuel filter, the atomisers and the fuel injection pump, see section 20.
- 12 Fit the lubricating oil pump and filter assembly, operation 19A-06.
- 13 Fit the anti-rotation tool. Fit the timing case, the toothed pulleys and the timing belt, see section 15. If a brush seal is not fitted to the timing case cover, fit the crankshaft pulley, operation 14A-01A or 14A-01B. Adjust the tension of the timing belt, operation 15A-03.
- 14 Remove the timing pins and the anti-rotation tool and turn the crankshaft through two revolutions. Check the timing of the fuel injection pump, operation 17A-03. Fit the timing case cover, operation 15A-01.
- 15 If a brush seal is fitted to the timing case cover, fit the anti-rotation tool and fit the crankshaft pulley, operation 14A-01A or 14A-01B. Remove the anti-rotation tool.
- 16 Fit the starter motor, operation 23B-01.
- 17 If necessary, fit the fan and the fan drive, see section 21.
- 18 Fit the alternator and its mounting bracket and the alternator drive belt, see section 23.
- 19 Marine engines: Fit the reverse gearbox, operation 22A-04.
- 20 If necessary, fit the turbocharger, operation 18A-02.
- 21 Install the engine in the application.
- 22 Fill the cooling system. For marine engines, see section 21.
- 23 Fill the lubricating oil sump to the correct level with an approved lubricating oil.
- 24 Eliminate air from the fuel system, operation 20A-10.

To inspect

16A-02

- 1 Clean the passages for the coolant and for the oil.
- 2 Check the cylinder block for cracks and for other damage.

The top face of the cylinder block cannot normally be machined as this will affect the piston height above the top face of the cylinder block. If high pistons (height grade 1) are fitted to all the bores, it may be possible to machine up to 0,26 mm (0.010 in) from the top face of the cylinder block and to fit low pistons (height grade 6). If the block is machined, the piston height must be checked to ensure that the pistons are not higher than the top limit as they could hit the valves and damage the engine.

- 3 Check the bores for wear (A) and other damage. The bores should be checked at the top, centre and bottom both along and across the engine (B). If a bore is damaged or worn by more than 0,15 mm (0.006 in) in diameter, the bores can be bored and honed 0,50 mm (0.0197 in) oversize in diameter and oversize pistons fitted. For best results bores should be honed at an inclusive angle of 30° to 35° with silicon carbide hones to give clean cuts. Base hone to give a roughness average of 1,5/2,0 micrometres and then plateau hone to give a roughness average of 0,7/1,4 micrometres.

After the bores have been bored oversize, stamp a letter "X" over the bore grades on the boss at the rear of the right side of the cylinder block (C).

If the surfaces of the bores are glazed, an engine can have high oil consumption with very little wear of the bores.

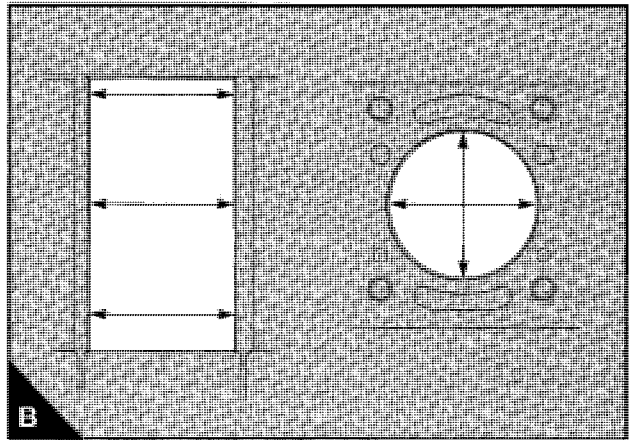
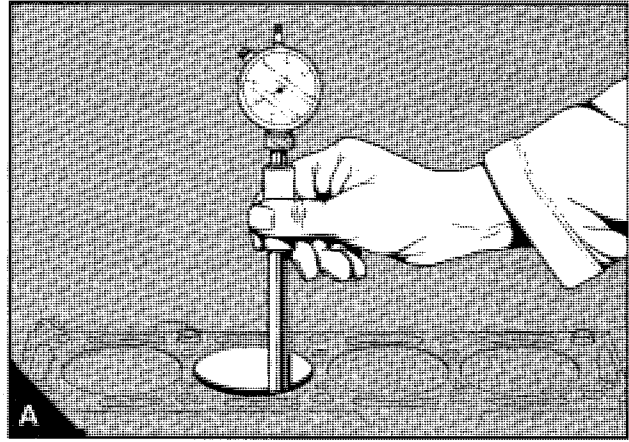

To correct a glazed bore

16A-03

A tool, known as a Flex-Hone, is available to correct the bore surface. This tool can be used with an electric hand drill at low speed. The pistons and connecting rods must be removed and the piston cooling jets, where fitted, must also be removed. Use covers to protect all engine components from the debris which is caused during the process.

- 1 A 3 1/2 in grade 80SC Flex-Hone can be used.
- 2 New Flex-Hones must be operated in an old bore before use in an engine to remove all loose material and sharp edges.
- 3 Lubricate lightly the bore and the Flex-Hone with clean engine lubricating oil.
- 4 Put the tool in position on top of the bore, but do not press the tool into the bore until the tool is operated.
- 5 Operate the tool and move it up and down the bore once a second for 30-50 seconds. Remove the tool while it rotates.
- 6 Clean thoroughly the bore to remove all dirt from the operation, use a hard brush and kerosene.
- 7 Dry the bores and remove carefully all the covers used to protect the components. Clean thoroughly all the engine components which have been affected by debris.
- 8 If necessary, fit the piston cooling jets. Ensure that new piston rings are fitted when the engine is assembled.

Attention: After a glazed bore has been corrected, these recommendations are advised for the first 240 km (150 miles) or 5 hours of operation:

- Do not operate the engine at full load.
- Do not operate the engine at high speed.
- Do not allow the engine to run at low idle speed for extended periods.

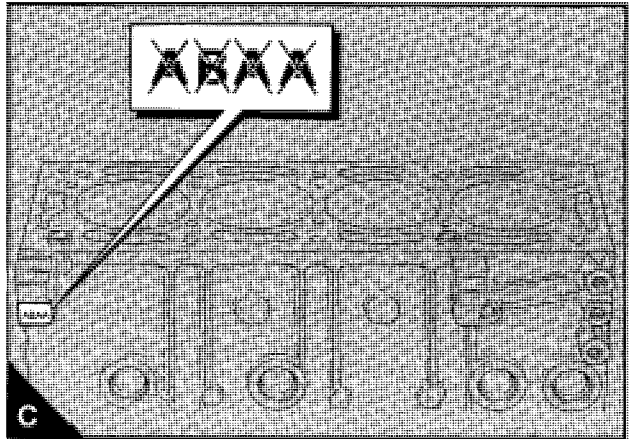

Engine timing

17

General description 17A.02

Engine timing

- 17A-01 To set number 1 piston to TDC compression stroke 17A.03
- 17A-02 To check and to adjust the valve timing 17A.03
- 17A-03 To check and to adjust the timing of the fuel injection pump 17A.04

General description

Location holes for timing pins are provided in the flywheel and in the front journal of the camshaft. When these holes are aligned with the timing holes in the flywheel housing or backplate and in the camshaft cover, number 1 piston is at top dead centre (TDC) on its compression stroke.

The toothed pulley for the fuel injection pump gear has two timing marks (A and B) and two keyways. The keyway which is on the same side as the relevant timing mark must always be used.

The timing of the fuel injection pump must always be checked after the tension of the timing belt has been adjusted.

Engine timing

To set number 1 piston to
TDC compression stroke

17A-01

Special tools:

Timing pins for camshaft and crankshaft, PD.182

- 1 Disconnect the battery and remove the setscrew from the timing hole in the top front of the camshaft cover.
- 2 Turn the crankshaft (in the normal direction of rotation - clockwise from the front) until the timing hole in the front journal of the camshaft aligns with the timing hole in the camshaft cover.
- 3 Fit the timing pins through the camshaft cover into the camshaft (A1) and through the flywheel housing or backplate into the flywheel. The position for the flywheel pin can be on either side of the engine, according to the engine application (B1). If one of the pins will not fit, adjust the valve timing, see operation 17A-02.

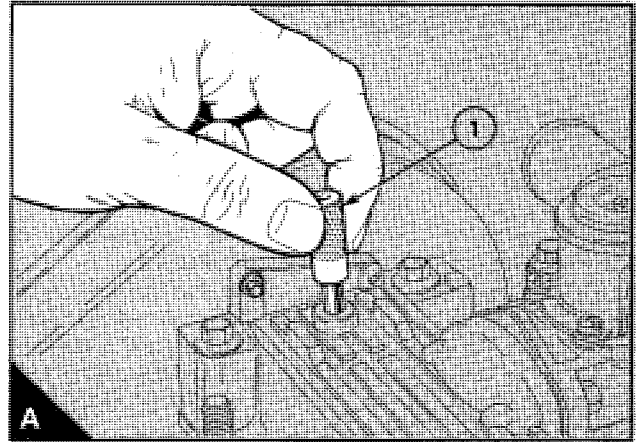

To check and to adjust the valve timing

17A-02

Special tools:

Timing pins for camshaft and crankshaft, PD.182

Anti-rotation tool, PD.203

Set the piston of number 1 cylinder to TDC compression stroke, operation 17A-01. If both the timing pins can be fitted, the valve timing is correct. If only one of the pins can be fitted, adjust the valve timing as follows;

- 1 If necessary, remove the timing pin from the flywheel, turn the crankshaft to align the timing hole in the camshaft with the hole in the camshaft cover and fit the camshaft timing pin.
- 2 Remove the timing case cover, operation 15A-01.
- 3 Two piece camshaft pulley: Loosen the four setscrews which fasten the camshaft pulley to its hub to allow the pulley to turn on the hub.
Single piece camshaft pulley: Remove the starter motor, fit the anti-rotation tool to the flywheel and loosen the centre setscrew of the pulley. If necessary, remove the anti-rotation tool.
- 4 Loosen the capscrew of the belt tensioner pulley and reduce the tension on the timing belt.
- 5 Turn the crankshaft to align the timing hole in the flywheel with the hole in the flywheel housing or backplate. Fit the flywheel timing pin.
- 6 Adjust the tension of the timing belt, operation 15A-03.
- 7 Tighten the setscrew(s) of the camshaft pulley to the correct torque, see section 11B. If a single piece pulley is fitted, the anti-rotation tool must be fitted during this operation.
- 8 Check the timing of the fuel injection pump, operation 17A-03.
- 9 **Remove the timing pins** and turn the engine through two revolutions to check that there is no restriction to movement.
- 10 Fit the timing case cover, operation 12A-01 and fit the setscrew in the timing hole in the camshaft cover.
- 11 If necessary, fit the starter motor.
- 12 Connect the battery.

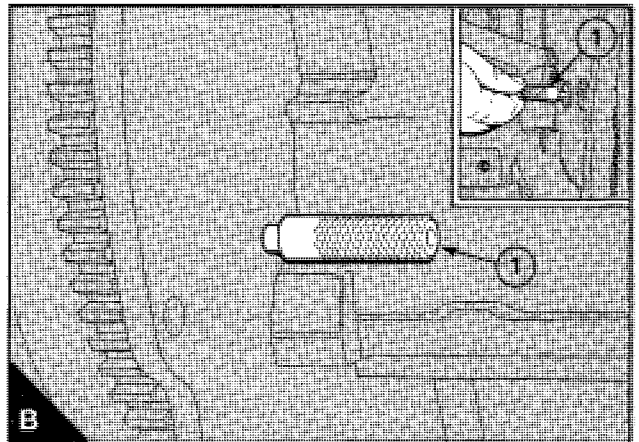

To check and to adjust the timing of the fuel injection pump

17A-03

Special tools:

Gauge to check plunger lift of fuel injection pump, PD.208

Adaptor for plunger lift gauge, MS.107

1 Set the piston of number 1 cylinder to TDC on the compression stroke, operation 17A-01. **Remove the timing pins.**

2 Remove the plug and the washer from the centre of the rear face of the fuel injection pump and fit the adaptor, number MS107 (A1). Fit the dial gauge PD.208 (A2) to the adaptor and set the gauge to indicate approximately 3,0 mm. Ensure that there is enough clearance between the gauge and the oil filler tube to allow for possible radial movement of the pump.

3 Slowly turn the crankshaft (counter-clockwise from the front of the engine) until the dial gauge indicates that the fuel pump plunger is at the bottom of its stroke. Set the dial to zero.

4 Slowly turn the crankshaft clockwise until the timing pin will enter the timing hole in the flywheel. In this position the dial gauge should indicate the correct plunger lift, see section 11C.

5 If the reading is not within 0,05 mm (0.002 in) of the correct setting, disconnect the high-pressure fuel pipes from the pump. Ensure that a spanner is used to prevent movement of the fuel pump outlets when the high pressure pipes are removed or fitted. Loosen the nuts for the pump flange and the setscrews for the rear support bracket.

If the reading is too low, turn the pump clockwise from the rear until the correct reading is obtained and then tighten the flange nuts and the bracket setscrews.

If the reading is too high, turn the pump counter-clockwise from the rear past the correct setting and then clockwise to the correct position. Tighten the flange nuts and the bracket setscrews.

Remove the timing pin from the flywheel, turn the crankshaft counter-clockwise approximately 45°. Check that the dial gauge is still set at zero and check the timing again. When the timing is correct, connect the high-pressure fuel pipes.

6 Remove the dial gauge and the adaptor and fit the plug and the washer to the pump. Tighten the plug to 10 Nm (7lbf ft) 1,0 kgf m.

7 Remove the timing pin from the flywheel and fit the setscrew in the timing hole in the camshaft cover.

8 Connect the battery.

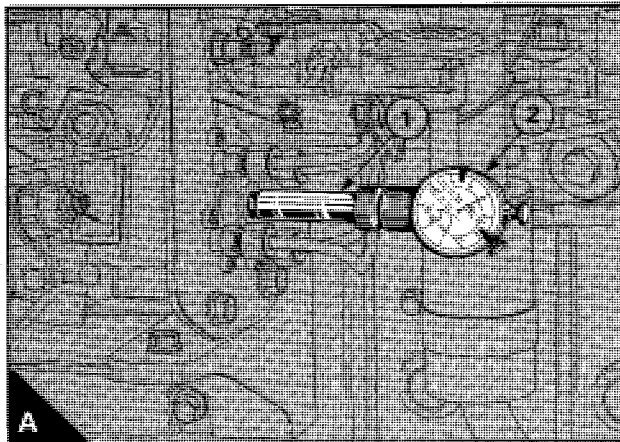

Aspiration system

18

	General description	18A.02
	Induction and exhaust manifolds																			
18A-01	To remove and to fit	18A.03
	Turbocharger																			
18A-02	To remove and to fit	18A.03
	Waste-gate unit	18A.04

General description

The ports of the inlet manifold are specially designed to match the combustion characteristics of the engine to ensure the best engine performance.

For marine engines, the exhaust manifold is an integral part of the header tank/heat exchanger/manifold assembly. The manifold is cooled by the coolant in the closed system. The induction air also passes through passages in this assembly between the induction manifold and the cylinder head.

The turbocharger, which is fitted between the exhaust and induction manifolds, is driven by exhaust gases. The turbocharger supplies air to the engine at more than atmospheric pressure. A waste-gate unit, which is controlled by boost pressure, is fitted to the turbocharger. This unit provides a by-pass for some of the exhaust gases to control the output of the turbocharger. The turbocharger is lubricated by oil from a connection in the body of the lubricating oil pump. The oil passes through the bearing housing of the turbocharger and returns to the lubricating oil sump.

Induction and exhaust manifolds

To remove and to fit

18A-01

For marine engines, see operation 21A-12.

1 Disconnect the air filter or the pipe from the air filter to the induction manifold. On turbocharged engines, disconnect the turbocharger, operation 18A-02.

2 Disconnect the exhaust pipe from the exhaust manifold or from the turbocharger. If necessary, remove the turbocharger, operation 18A-02.

3 Loosen the setscrews gradually and evenly in the reverse sequence to that shown in figure C. The top four setscrews are common to both of the manifolds and are fitted with washers. Remove the setscrews and washers and remove the induction manifold (A) and the exhaust manifold (B). Remove the gasket.

4 Check the manifolds for cracks and other damage. Ensure that the faces of the manifolds and the cylinder head are clean.

5 Put a new gasket in position with the side of the gasket which is marked "THIS SIDE OUT" towards the manifolds (B). Do not apply jointing compound to the gasket.

6 Put the exhaust manifold in position and loosely fit the bottom setscrews. Fit the induction manifold and its setscrews. Washers must be fitted to the top four setscrews which fasten the flanges of both manifolds. Tighten the manifold setscrews gradually and evenly to 22 Nm (16 lbf ft) 2,2 kgf m, in the sequence shown in figure C.

7 Connect the air filter or the pipe from the air filter to the induction manifold.

8 Connect the exhaust pipe.

Turbocharged engines: Fit the turbocharger, operation 18A-02 and then fit the exhaust pipe.

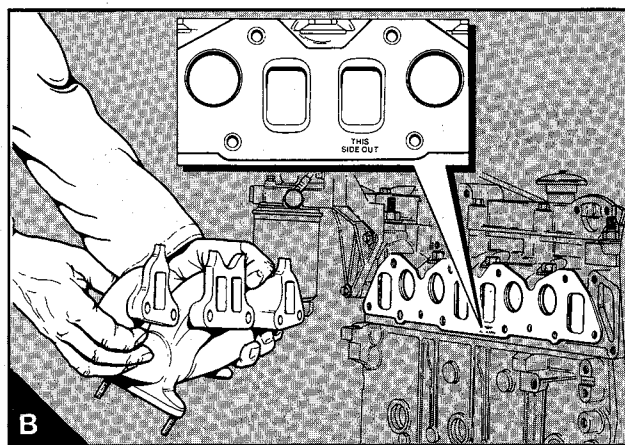
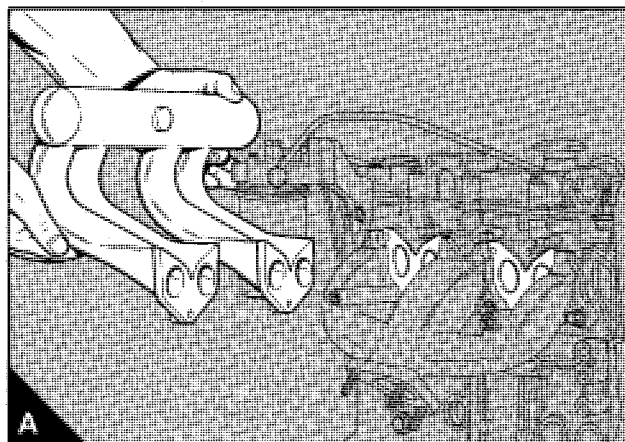

Turbocharger

To remove and to fit

18A-02

Special tool:

Spanner for oil pipe connection at turbocharger, PD.201

To remove

1 Thoroughly clean the turbocharger.

2 Remove the air filter or the air filter hose at the turbocharger compressor inlet.

Marine engines: Remove the induction cap, if necessary.

3 Disconnect the exhaust pipe.

4 Release the hose clips and push the hose of the compressor outlet up the elbow of the induction manifold.

Marine engines: Release the spring clips and remove the heat shield.

5 Disconnect the oil supply pipe and the oil drain pipe at the turbocharger. Special spanner PD.201 can be used to disconnect the supply pipe at the turbocharger. Disconnect the boost pressure pipe at the turbocharger.

6 Release the nuts at the turbocharger flange and remove the turbocharger (D) and the gasket. If necessary, remove the exhaust elbow and its joint from the turbocharger. Fit covers to the openings in the turbocharger to ensure that dirt, etc. will not enter.

7 Fit covers to the ends of the pipes and the openings in the manifolds or in the header tank / heat exchanger / manifold assembly.

8 Check the air hoses and the oil drain hose for cracks or other damage and renew them, if necessary.

9 If necessary, remove and clean the oil drain pipe.

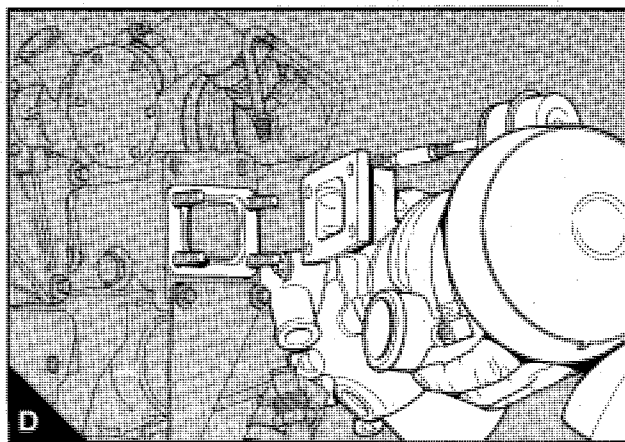
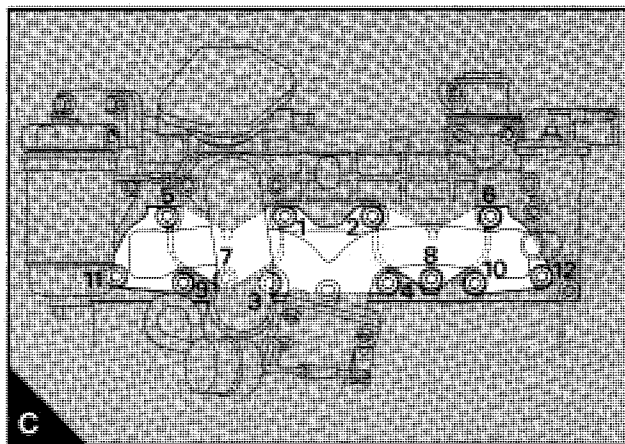

To fit

- 1 Remove the covers from the components.
- 2 Check that the turbocharger inlets and outlets are clean and free from restriction and that the turbocharger shaft rotates freely. Also check that the manifold and exhaust pipe openings are clean and free from restriction.
- 3 Fit a new gasket to the exhaust manifold to turbocharger flange. Ensure that the threads of the studs are clean and apply a suitable compound to the studs to prevent seizure. Fit the turbocharger, fit the nuts and tighten them to 22 Nm (16 lbf ft) 2,2 kgf m.

Marine engines: Ensure that the heatshield bracket is fitted correctly before the flange nuts are fitted and tightened. Fit the heatshield.

- 4 If necessary, fit the exhaust elbow to the turbocharger. Ensure that the faces of the elbow and of the turbocharger are clean and fit a new joint. Tighten the nuts to 22 Nm (16 lbf ft) 2,2 kgf m.

- 5 Connect the oil drain pipe and the boost control pipe to the turbocharger.

- 6 Insert 100/140 ml (4/5 fluid ounces) of clean engine lubricating oil through the inlet port in the centre casing of the turbocharger. Turn the rotating assembly by hand to send the oil around the bearings.

- 7 Slide the hose on the induction manifold elbow onto the compressor outlet and tighten the hose clips.

- 8 Check that the passages in the air filter and hose or in the induction cap and pipe are clean. Fit the air filter or the induction cap and tighten the hose clips.

- 9 Put the oil supply pipe in position but leave it disconnected.

Non-marine engines: Disconnect the stop solenoid at the fuel injection pump and operate the starter motor until oil flows from the supply pipe. Connect the stop solenoid.

Marine engines: Operate the starter motor with the stop button pressed or with the stop control lever in the "stop" position until oil flows from the supply pipe. Ensure that the stop control lever returns to the "run" position.

Connect the oil supply pipe. The special spanner PD.201 can be used to tighten the connection.

Marine engines: Fit the heatshield and its spring clips.

- 10 Start the engine and check for lubricating oil and air leaks (especially from the boost sensor pipe that is fitted between the compressor casing and the waste-gate actuator). The engine should be operated at low speed for three to four minutes to allow for oil circulation before the speed is increased.

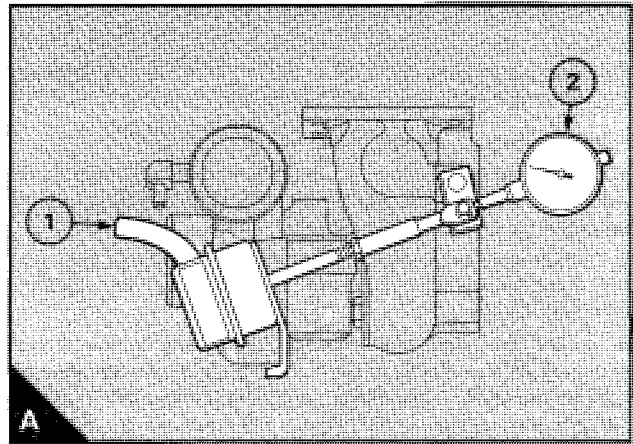

- 2 Check that the pressure needed to move the rod 0,38 mm (0.015 in) is within the limits of 89/97 kPa (12.9/14.1 lbf/in²) 0,91/0.99 kgf/cm². Ensure that the dial indicator returns to zero when the air pressure is released. Repeat the test several times to ensure that an accurate reading is obtained. It may be necessary to lightly hit the turbine housing with a soft hammer during the test operation.

- 3 If the operation of the waste-gate is not correct, the turbocharger must be renewed. No adjustment is allowed.

- 4 Remove the test equipment and connect the boost sensor pipe.

Waste-gate unit

If the by-pass valve of the waste-gate does not open at the correct pressure, this will affect the performance of the engine.

A low pressure setting can cause black exhaust smoke at rated speed and loss of power at 2500 rev/min.

A high pressure setting can cause high cylinder pressures which can cause failure of the cylinder head gasket and damage to the bearings and pistons.

The pressure setting can be checked as follows:

- 1 Disconnect the boost sensor pipe (A1) and connect an air supply which can be accurately controlled and is fitted with an accurate gauge. Fasten a dial test indicator to the turbocharger with the end of the plunger in contact with the end of the actuator rod to measure axial movement of the rod (A2).

Lubrication system

19

	General description	19A.02
	Filter canister		
19A-01	To renew	19A.03
	Filter head		
19A-02	To remove and to fit	19A.03
	Lubricating oil sump		
19A-03	To remove and to fit	19A.04
	Oil strainer and suction pipe		
19A-04	To remove and to fit	19A.04
19A-05	To inspect and to correct	19A.04
	Lubricating oil pump		
19A-06	To remove and to fit	19A.05
19A-07	To inspect	19A.06
	Relief valve		
19A-08	To remove and to fit	19A.07
19A-09	To inspect	19A.07

General description

The lubricating oil pump is fitted around the forward end of the crankshaft; the inner rotor of the pump is driven by a key in the crankshaft. The pump has an inner rotor and an outer rotor which are offset to each other. The inner rotor has ten lobes which mesh with the eleven lobes of the outer rotor. When the pump turns, the space between the lobes which are in mesh increases to cause a suction or decreases to cause a pressure increase.

Lubricating oil from the sump passes through a strainer and pipe to a passage in the cylinder block and then to the suction side of the pump.

A relief valve (which is fitted in the pump body) opens if the pressure is too high; this allows some of the oil from the outlet side of the pump to return to the inlet side of the pump.

From the pump the oil passes through a filter which is fitted to the pump body. After the filter the oil passes to the pressure rail which is drilled through the length of the block.

From the pressure rail, lubricating oil passes to the crankshaft main bearings and through passages in the crankshaft to the big end bearings. The pistons and the cylinder bores are lubricated by splash and oil mist.

Oil passes (through passages in the block and the cylinder head) from the rear of the pressure rail in the block to a pressure rail in the head. From the pressure rail in the head, oil passes to each camshaft journal. The valves and the tappets are lubricated by splash and oil mist.

The turbocharger is lubricated by oil which passes through a pipe from the body of the oil pump or from the filter head. After it has passed through the turbocharger, the oil returns through a drain pipe to the sump.

Most turbocharged engines have piston cooling jets fitted. These jets are connected to the pressure rail in the cylinder block and spray lubricating oil inside the pistons to keep them cool.

Some engines are fitted with a lubricating oil cooler. This is connected by pipes to the oil pump and to the filter head. The oil passes through the cooler before it goes to the filter. For some applications, most of the oil goes through the cooler but a small quantity goes through a restricted by-pass direct to the filter.

Filter canister

To renew

19A-01

- 1 Put a tray under the filter to contain spilt lubricating oil.
- 2 Remove the filter canister with a strap wrench or a similar tool. Ensure that the adaptor (A1) is secure in the filter head and then discard the canister.
- 3 Clean the filter head.
- 4 Add clean engine lubricating oil to the new canister. Allow time for the oil to fill the canister through the filter element.
- 5 Lubricate the top of the canister seal with clean engine lubricating oil.
- 6 Install the new canister and tighten it by hand only. Do not use a strap wrench.
- 7 Ensure that there is lubricating oil in the sump.
Turbocharged non-marine engines: Disconnect the stop solenoid at the fuel injection pump and operate the starter until oil pressure is indicated on the pressure gauge or until the oil warning light is extinguished. Connect the stop solenoid.
Turbocharged marine engines: Operate the starter motor with the stop button pressed or with the stop control lever of the fuel pump in the "stop" position until the oil pressure warning light is extinguished. Ensure that the stop control lever returns to the "run" position.
- 8 Operate the engine and check for leakage from the filter. When the engine has cooled, check the oil level on the dipstick and add oil to the sump, as necessary.

Attention: The canister contains a valve and a special tube which ensure that lubricating oil does not drain from the filter. Therefore, ensure that the correct Perkins POWERPART canister is used.

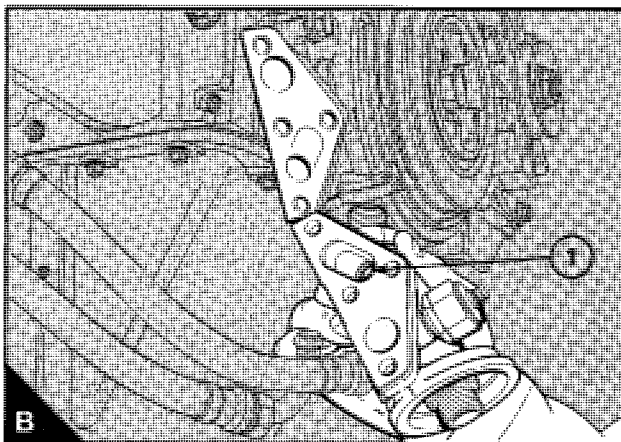
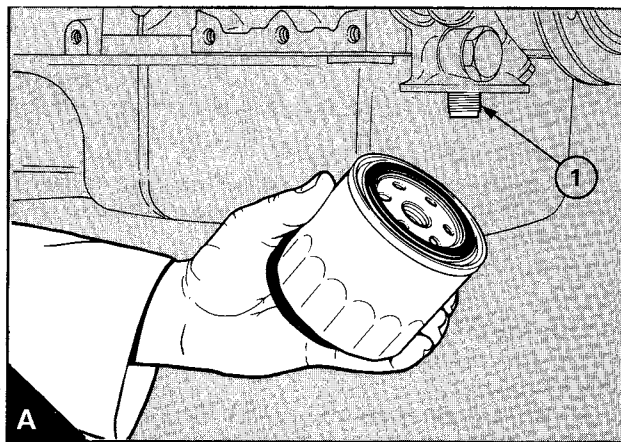

Filter head

To remove and to fit

19A-02

- 1 Put a tray under the filter head to contain spilt lubricating oil.
- 2 Remove the filter canister, operation 19A-01.
- 3 If necessary, disconnect the oil cooler pipe and/or the turbocharger oil pipe from the filter head.
- 4 Release the setscrews and remove the filter head from the lubricating oil pump. Discard the joint.
- 5 Clean the joint faces of the filter head and of the oil pump.
If an oil cooler is used, ensure that a plug is fitted in the filter head (B1). For some applications, the plug will have a small hole in it to allow some of the oil to pass directly to the filter.
- 6 Fit the filter head and a new joint to the oil pump and tighten the setscrews to 22 Nm (16 lbf ft) 2,2 kgf m.
- 7 If necessary, connect the oil cooler pipe and/or the turbocharger oil pipe.
- 8 Fit a new filter canister, operation 19A-01.

Lubricating oil sump

To remove and to fit

19A-03

- 1 Operate the engine until it is warm.
- 2 Stop the engine, remove the sump drain plug and its washer and drain the oil. For marine engines, the sump can be drained by use of the sump drain pump.
- 3 Remove the dipstick. Disconnect the drain pipe(s) of the breather.

Marine engines: Remove the sump drain pump.

Turbocharged engines: Disconnect the drain pipe of the turbocharger.

- 4 Where necessary, provide a support for the sump. Remove the setscrews which fasten the sump to the cylinder block. Lower the sump and remove the joint.

5 Wash the sump with clean kerosene, ensure that all the kerosene is removed. Clean the flange faces of the sump and of the cylinder block.

6 If the front or the rear main bearing cap has been removed, apply sealant as instructed in item 15 of operation 14A-09.

7 Put a new sump joint in position on the sump or on the cylinder block. If a two piece joint is to be used, apply POWERPART Sealant to the ends of each half joint and ensure that the ends are fitted together correctly. Fit the sump and ensure the correct location with a setscrew on each side. Fit the remainder of the setscrews and tighten all the setscrews to 12 Nm (9 lbf ft) 1,2 kgf m. If necessary, fit the drain plug and its washer and tighten the plug to 43 Nm (32 lbf ft) 4,4 kgf m.

8 Fit the dipstick. Connect the drain pipe(s) of the breather.

Marine engines: Fit the sump drain pump.

Turbocharged engines: Connect the drain pipe of the turbocharger.

9 Fill the sump to the "MAX" level on the dipstick with an approved lubricating oil.

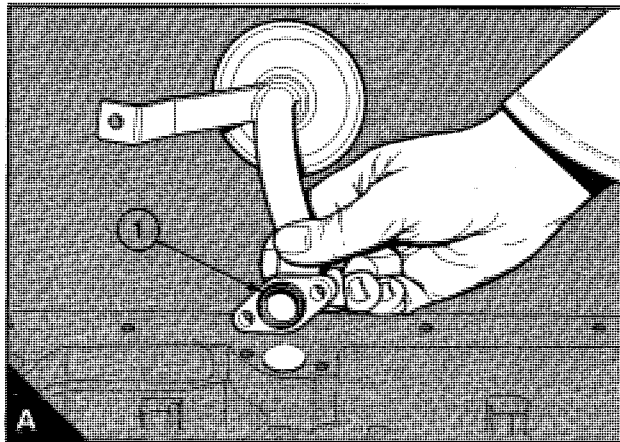

Oil strainer and suction pipe

To remove and to fit

19A-04

The oil strainer is an integral part of the suction pipe. No regular service is necessary but wash the strainer when it is removed.

- 1 Remove the sump, operation 19A-03.
- 2 Release the setscrew which holds the bracket to the main bearing cap.
- 3 Release the flange setscrews of the suction pipe and remove the suction pipe and strainer. Remove the "O" ring (A1). Clean the flange face of the cylinder block and of the suction pipe.
- 4 Loosely assemble the suction pipe bracket to the correct main bearing cap. Fit the suction pipe to the oil pump together with a new "O" ring. Tighten the setscrews. Tighten the setscrew of the suction pipe bracket; ensure that there is no stress on the suction pipe.
- 5 Fit the sump, operation 19A-03 and fill it with an approved oil to the "MAX" level on the dipstick.

To inspect and to correct

19A-05

- 1 Wash the assembly in kerosene and dry it thoroughly.
- 2 Check the pipe, the strainer and the welded joints for cracks and other damage. Check that the mounting bracket is secure.
- 3 If the damaged component cannot be welded correctly, renew the assembly.

Lubricating oil pump

To remove and to fit

19A-06

To remove

- 1 Disconnect the battery.
- 2 Remove the setscrew from the timing hole in the top front of the camshaft cover. Turn the crankshaft until the timing hole in the front journal of the camshaft aligns with the hole in the cover.
- 3 Fit the timing pins to the camshaft and to the flywheel, see section 17.
- 4 If necessary, remove the fan. Remove the drive belt of the alternator, operation 23A-03 and remove the pulley of the water pump.
- 5 Remove the crankshaft pulley, operation 14A-01A or 14A-01B.
- 6 Remove the timing case cover, operation 15A-01.
- 7 Remove the timing belt, the toothed pulleys and the timing case, see section 15.
- 8 Remove the front key of the crankshaft.
- 9 Release gradually and evenly the setscrews of the oil pump in the reverse sequence to that shown in figure D.
- 10 Remove the oil pump (A). If necessary, remove the pulley guard which is fitted to some vehicle engines.

To fit

Special tool:

Protection sleeve, PD.193

- 1 Ensure that the joint faces of the oil pump, the cylinder block and the main bearing cap are clean. Apply POWERPART Sealant (Loctite 518) where the main bearing cap meets the cylinder block (see 14A.10A). Ensure that the two dowels (A1) are in position and put a new joint into position (A2). Where a pulley guard is used (some vehicle engines), ensure that it is in position at the top of the pump and is held by the small setscrew in the pump body.
- 2 Ensure that the rear key is in position and that the chamfered end of the key is towards the front (B). If the front key is still in position, remove it from the crankshaft.
- 3 Clean the crankshaft and the protection sleeve PD.193 and lightly lubricate them with clean engine oil. Fit the protection sleeve (C1) to the crankshaft.
- 4 Turn the rotors of the oil pump until the keyway in the inner rotor will align with the key in the crankshaft. If the seal is fitted in the front of the pump, lightly lubricate it with clean engine oil. Carefully put the pump into position with the keyway over the key and with the dowels fitted into the pump housing. Remove the protection sleeve.
- 5 Put the pump setscrews in position with a suitable sealant applied to the setscrew which fits into the main bearing cap (D1). Sealant is already applied to new setscrews. Some vehicle engines have a pulley guard fitted to the top of the pump. Tighten the setscrews gradually and evenly to the correct torque, see section 11B, in the correct sequence (D).
- 6 Where necessary, fit the front oil seal into the pump, see operation 14A-02.
- 7 Fit a new front key to the crankshaft.
- 8 Fit the timing case, operation 15A-08.
- 9 Fit the toothed pulleys and the timing belt, see section 15. Check the timing of the fuel injection pump, operation 17A-03.
- 10 Fit the timing case cover, operation 15A-01.
- 11 Fit the crankshaft pulley, operation 14A-01A or 14A-01B.
- 12 Fit the pulley of the water pump and the drive belt of the alternator, operation 23A-03. Where necessary, fit the fan, operation 21A-09.

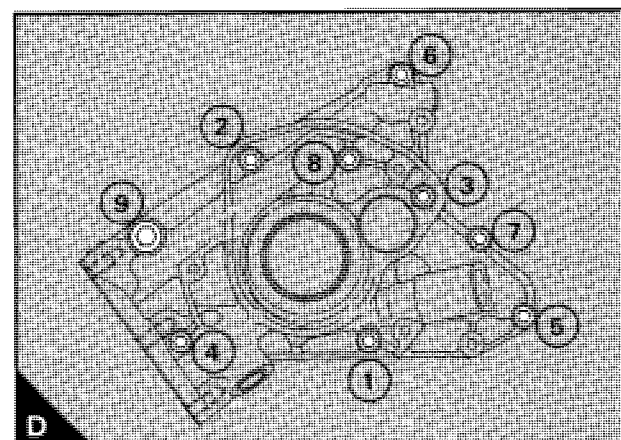
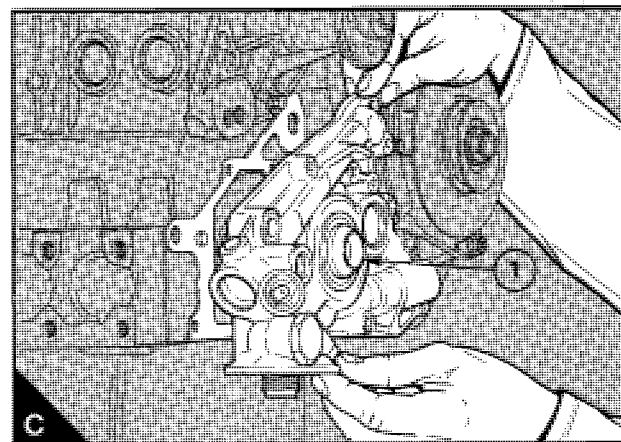
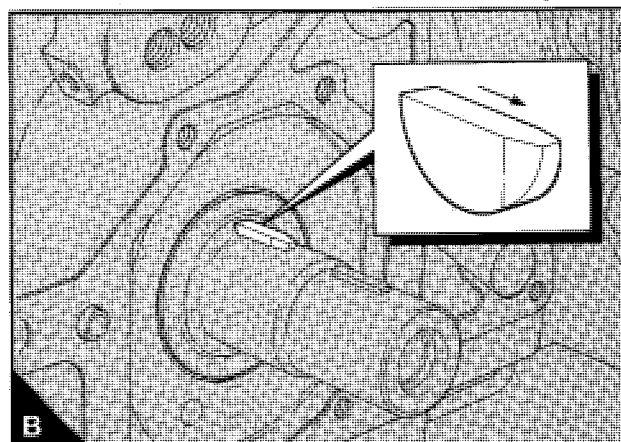
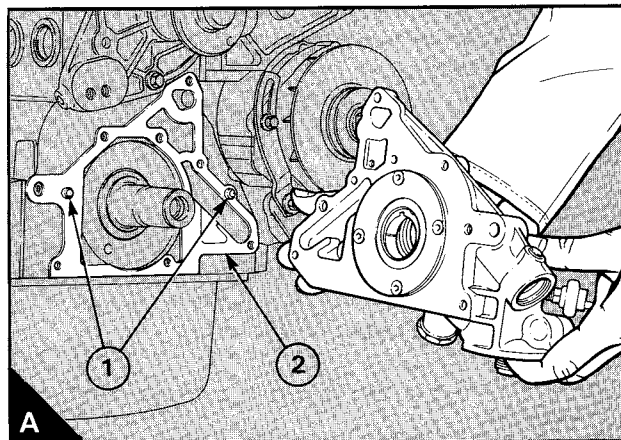

13 Ensure that the timing pins have been removed and fit the setscrew in the timing hole in the top front of the camshaft cover.

14 Connect the battery.

15 Ensure that the engine will not start and operate the starter motor until there is a reading on the oil pressure gauge or the oil warning light is extinguished.

To ensure that a non-marine engine will not start: Disconnect the stop solenoid at the fuel injection pump.

To ensure that a marine engine will not start: Move the stop control lever on the fuel injection pump to the "stop" position or press the stop button while the starter motor is in operation.

16 Start the engine and check for leaks.

To inspect

19A-07

If the rotors are worn enough to have an effect on the performance of the oil pump, the complete oil pump must be renewed.

- 1** Release the screws and remove the backplate of the oil pump.
- 2** Remove the rotors and clean thoroughly all the components. Check for cracks and other damage.
- 3** Fit the rotors inside the pump and check the outer rotor to body clearance (A).
- 4** Check the inner rotor to outer rotor clearance (B).
- 5** Check the rotor end-float with a straight edge and a feeler gauge (C). For all the above clearances, see section 11C.
- 6** If the oil seal is to be renewed, remove the rotors and press the seal from the body. The pump is easier to fit to the engine without the seal in position and the seal can be fitted with the pump on the engine, see operation 14A-02.

If necessary, the seal can be fitted with the pump off the engine. Ensure that the lip seal is to the inside of the pump and that the seal is fitted squarely in the pump. Use a suitable adaptor and press the seal into the pump until the front face of the seal is 0,5 mm (0.02 in) below the front face of the housing.

- 7** Lightly lubricate the rotors with clean engine oil and fit them to the pump. The inner rotor of later pumps has a spigot on one end and this spigot must be fitted towards the seal housing. Fit the backplate with the word "TOP" away from the straight edge of the pump body (D). Fit and tighten the backplate screws to 4 Nm (3 lbf ft) 0,4 kgf m.

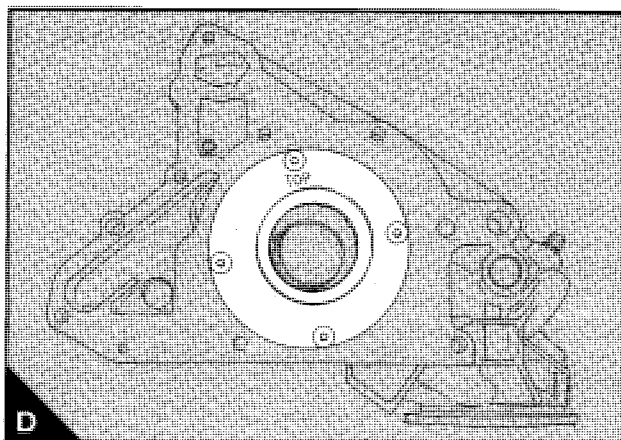
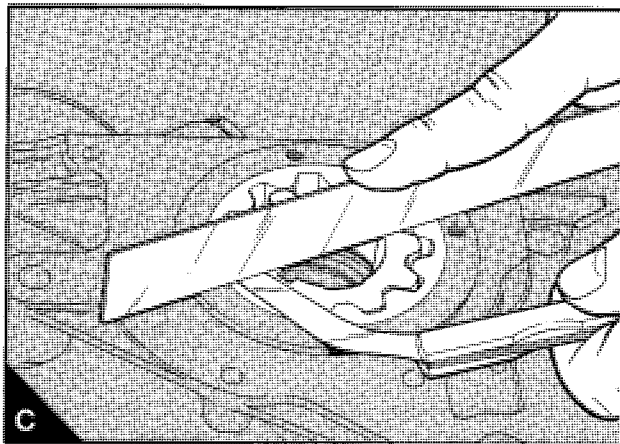
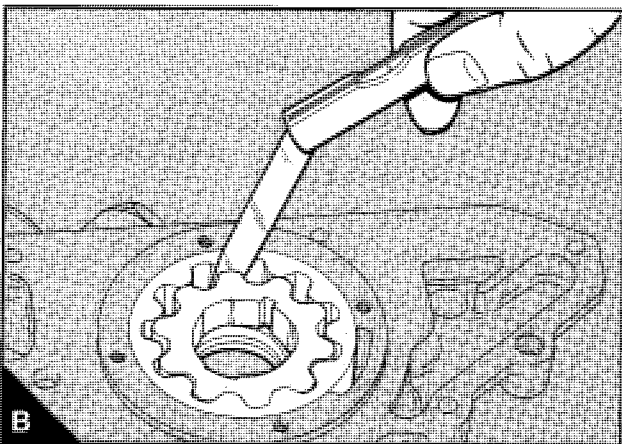
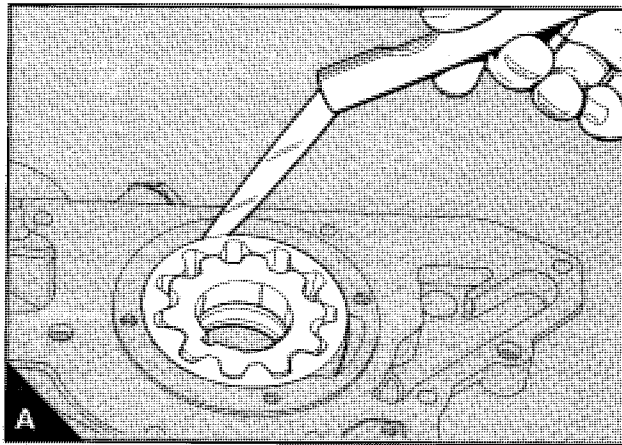

Relief valve

To remove and to fit

19A-08

The relief valve is fitted inside the left side of the pump body and cannot be removed as an assembly. The pressure setting is not adjustable except by the installation of new parts.

- 1** Straighten the open ends of the split pin (A1). Apply pressure to the end plug (A4) and remove the split pin from the pump body.
- 2** Release the pressure from the end plug and, if possible, remove the plug and the spring (A3). If the plug does not come out, lightly hit it inwards to see if the spring pressure will push it out of the housing. If the plug will still not come out, drill a small hole in the centre of the plug; use a self-tapping screw to remove the plug.
- 3** Remove the spring and the plunger (A2). A small magnet can be used to remove the plunger.
- 4** Renew the split pin, the "O" ring (A5) and the end plug (if the plug has been drilled).
- 5** Ensure that all the components are clean and lubricate them with clean engine oil. Fit the new "O" ring to the end plug.
- 6** Fit the plunger into the sleeve in the housing with the open end of the plunger towards the inside. Fit the spring over the boss on the end of the plunger. Fit the end plug with the end of the spring fitted inside the recess in the plug.
- 7** Press in the end plug and fit the split pin through the top hole in the housing and then through the bottom hole. Bend over the ends of the split pin.

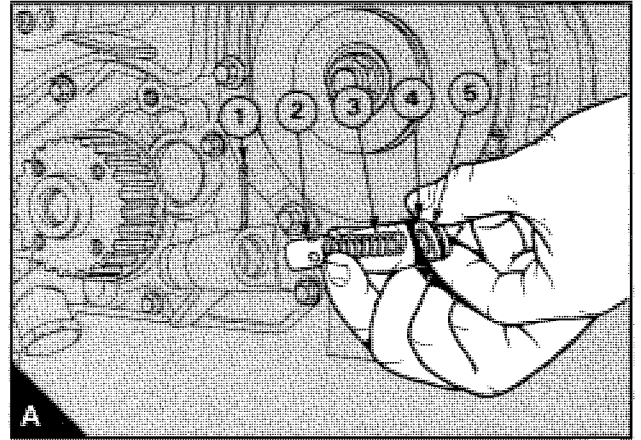

To inspect

19A-09

- 1** Check the spring for wear and other damage and, if possible, check the load necessary to compress the spring to its fitted length, see section 11C.
- 2** Check the plunger for wear and other damage and ensure that it slides easily in the sleeve of the housing.
- 3** Check the body and the end plug for wear and other damage.
- 4** Renew worn or damaged components.



Fuel system

20

	General description	20A.02
	Fuel filter canister																		
20A-01	To renew	20A.03
	Atomisers																		
	Atomiser fault	20A.03
20A-02	To remove and to fit	20A.03
	Lift pump																		
20A-03	To remove and to fit	20A.04
20A-04	To dismantle and to assemble	20A.04
20A-05	To test	20A.05
	Fuel injection pump																		
20A-06	To remove and to fit	20A.06
20A-07	To adjust	20A.07
20A-08	To check the cold idle device	20A.08
20A-09	To check the cold start advance unit	20A.08
	Fuel system																		
20A-10	To eliminate air from the fuel system	20A.09

General description

All engines are fitted with a Bosch fuel injection pump. These pumps have mechanical governors to control the engine speed.

The pumps fitted to vehicle engines and some marine engines have a cold start advance unit which is fitted to the side of the pump. This unit alters the timing of the fuel injection when the engine is cold, to improve the engine start. For some engines the unit is controlled electrically by a temperature switch which is fitted in the cylinder head. For other engines the unit is controlled by the temperature of the pump.

The pumps fitted to some vehicle engines have a device which increases the idle speed of the engine when it is cold. This device is controlled by a temperature switch which is fitted into the thermostat housing.

The pumps which are fitted to most turbocharged engines have a boost control. The boost control is a device which is affected by boost pressure (from the turbocharger) and reduces the maximum fuel delivery at lower engine speeds to match the reduced air supply to the cylinders.

The atomisers receive high pressure fuel from the fuel injection pump and inject this fuel into the combustion chambers as a very fine spray. The pressure at which atomisers operate can be corrected by a change of shims fitted above the spring.

The fuel injection equipment must only be checked and adjusted by personnel who have had the correct training.

The lift pump is a diaphragm type pump and is mechanically driven. It is fitted on the right side of the camshaft cover and is driven by an eccentric on the camshaft. The pump is fitted with a priming lever.

It is very important that dirt does not enter the fuel system. Before a connection is disconnected, clean thoroughly the area around the connection. After a component has been disconnected, fit a suitable cover to all open connections.

Fuel filter canister

To renew

20A-01

1 Thoroughly clean the outside surfaces of the fuel filter assembly. Loosen, by two or three turns, the vent screw (A1) which is fitted in the top of the filter. Loosen the drain device (A2) at the bottom of the canister and drain the fuel into a suitable container.

2 Use a strap wrench or similar tool to loosen the filter canister and remove the canister (B).

3 Ensure that the threaded adaptor (B1) is secure in the filter head and that the inside of the head is clean. Ensure that the seal (B2) which is supplied with the new canister is in position on the top of the canister.

4 Lubricate lightly the top seal of the new canister with clean fuel. Fit the new canister to the filter head and tighten, by hand only.

5 Eliminate the air from the fuel filter, see operation 20A-10.

Attention: It is important that only the genuine Perkins fuel filter canister is used. The use of a wrong canister can damage the fuel injection pump.

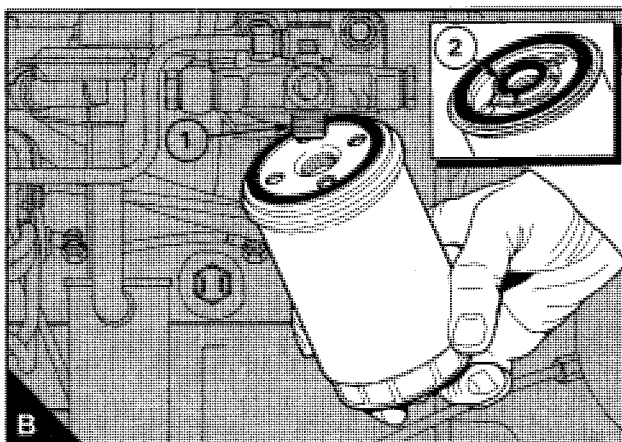
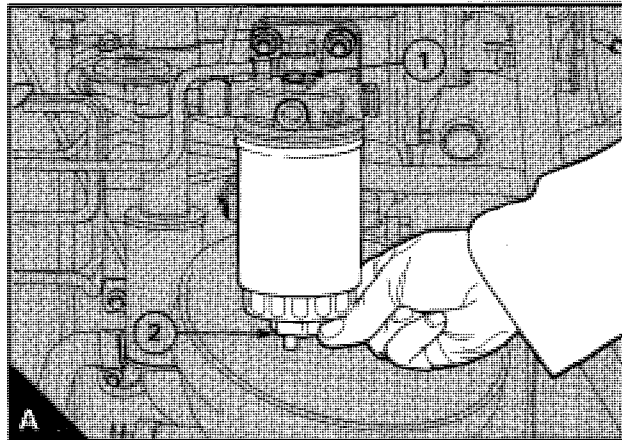

Atomisers

Atomiser fault

An atomiser fault can cause an engine misfire.

To find which atomiser is defective, operate the engine at a fast idle speed. Loosen and tighten the union nut of the high-pressure fuel pipe at each atomiser. When the union nut of the defective atomiser is loosened, it has little or no effect on the engine speed.



Ensure that the fuel does not spray onto your skin.

To remove and to fit

20A-02

Special tools:

Slide hammer for atomiser removal, PD.184

Adaptor for Bosch atomisers for use with PD.184, PD.184-1

Adaptor for CAV atomisers for use with PD.184, PD.184-2

1 The two stage CAV atomisers (C1) which are fitted to some naturally aspirated vehicle engines are longer than the single stage atomisers (C2). The cap nut of these two stage atomisers must not be loosened as this will cause interference to the pressure setting.

2 The two stage (Bosch) atomisers which are fitted to some turbocharged vehicle engines are approximately the same length as the single stage atomisers. The pressures of the two stage atomisers cannot be reset in service.

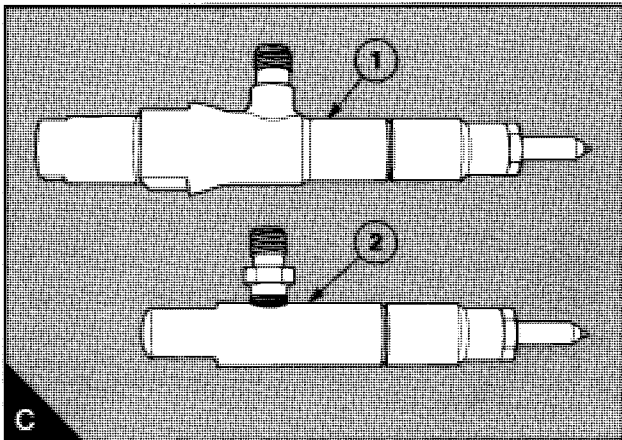

1 Single stage atomisers and two stage Bosch atomisers

1 Remove the fuel leak-off pipe.

2 Remove the union nuts of the high-pressure pipe from the atomiser and from the fuel injection pump. Hold the pump outlet with a spanner to prevent movement while the union is released at the pump. Do not bend the pipe. If necessary, remove the pipe clamps.

3 Release the clamp setscrew of the atomiser. The spacer (D2) will be either 31,5 mm (1.2 in) or 7 mm (0.3 in) long, according to the type of atomiser used. If a short spacer is used, lift the spring assembly during the setscrew removal operation. This will ensure that the thread of the setscrew does not enter the hole in the bottom spring. Remove the clamp assembly (D1) and the spacer.

4 Remove the atomiser (D3) and its seat washer (D4). If the atomiser

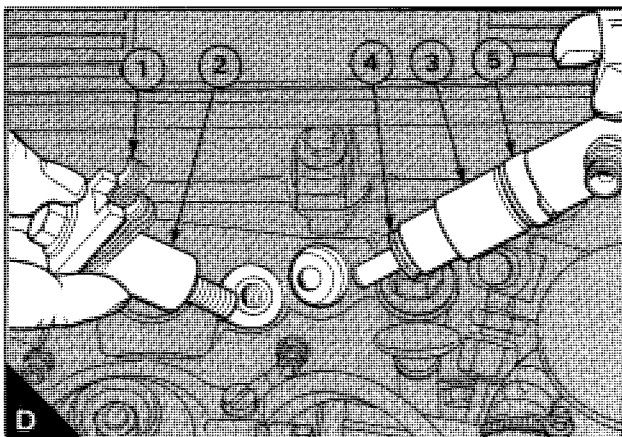

If it is tight in the cylinder head, use the slide hammer (A1) and the relevant adaptor (A2).

- 4 Check the clamp assembly for damage or distortion and, if necessary, renew the assembly. Renew the atomiser seat washer.
- 5 Ensure that the atomiser location ring (20A.03/D5) is in position in the cylinder head and put the new atomiser and seat washer into position. Ensure that the atomiser is not tilted. Fit the clamp assembly and the spacer with the arms of the clamp fitted squarely on the shoulders of the atomiser. Tighten the clamp setscrew to 43 Nm (32 lbf ft) 4,4 kgf m.
- 6 Fit the high-pressure fuel pipe and tighten the union nuts to 18 Nm (13 lbf ft) 1,8 kgf m. Hold the pump outlet with a spanner to prevent movement while the union nut is tightened at the pump. If necessary, fit the pipe clamps.
- 7 Fit the leak-off pipe.
- 8 Operate the engine and check for leakage of fuel and air.

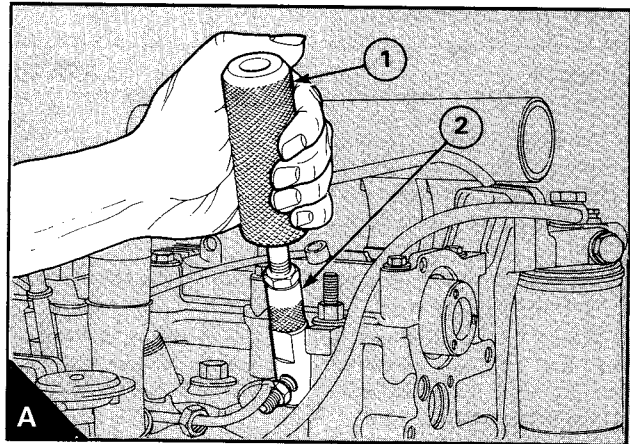

Two stage CAV atomisers

- 1 Remove the fuel leak-off pipe.
- 2 Remove the union nuts of the high-pressure pipe from the atomiser and from the fuel injection pump. Hold the pump outlet with a spanner to prevent movement while the nut is released at the pump. Do not bend the pipe. If necessary, remove the pipe clamps.
- 3 Release and remove the nut (B7), the special washer (B6), and the clamp (B5). Remove the atomiser (B2) and its seat washer (B3). If the atomiser is tight in the cylinder head, use the slide hammer (A1) and the relevant adaptor (A2).
- 4 Check that the support (B4) for the clamp is secure. If the supports are removed, they must be aligned correctly when they are fitted, as shown in C and the nuts tightened to 43 Nm (32 lbf ft) 4,4 kgf m.
- 5 Ensure that the location ring (B1) is in position in the cylinder head and put the atomiser and a new seat washer into position. Ensure that the atomiser is not tilted. Fit the clamp over the atomiser and the stud with the chamfer at the top. Put the special washer in position with its chamfer towards the chamfer in the clamp. Fit and tighten the nut to 23 Nm (17 lbf ft) 2,3 kgf m. It is important that the correct torque is used as damage can occur if the nut is overtightened.
- 6 Fit the high-pressure fuel pipe and tighten the union nuts to 18 Nm (13 lbf ft) 1,8 kgf m. Hold the pump outlet with a spanner to prevent movement while the union nut is tightened at the pump. If necessary, fit the pipe clamps.
- 7 Fit the leak-off pipe.
- 8 Operate the engine and check for leakage of fuel and air.

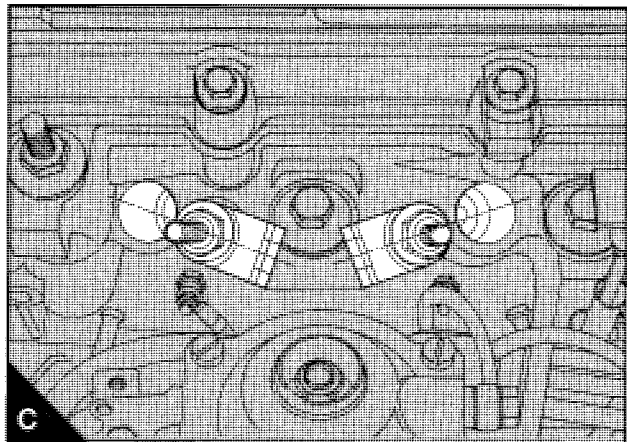
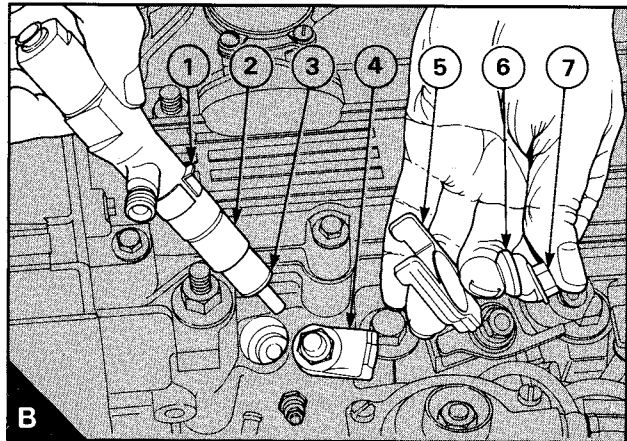

Lift pump

To remove and to fit

20A-03

- 1 Disconnect the fuel pipes from the lift pump.
- 2 Remove the setscrew from the timing hole in the top front of the camshaft cover. Turn the crankshaft until the timing hole in the front journal of the camshaft aligns with the hole in the cover. This will ensure that the highest point of the drive eccentric is away from the pump lever.
- 3 Release the setscrews and remove the lift pump (D).
- 4 Clean the joint faces of the lift pump and of the camshaft cover and fit the lift pump together with a new joint. Fit the setscrews and tighten them gradually and evenly to 22 Nm (16 lbf ft) 2,2 kgf m.
- 5 Connect the fuel pipes.
- 6 Release the vent screw on the fuel filter head. Operate the priming lever of the lift pump to eliminate any air between the lift pump and the fuel filter. Operate the lever until fuel, free of air, comes from the vent screw. Tighten the vent screw.
- 7 Operate the engine and check for any fuel or air leakage.

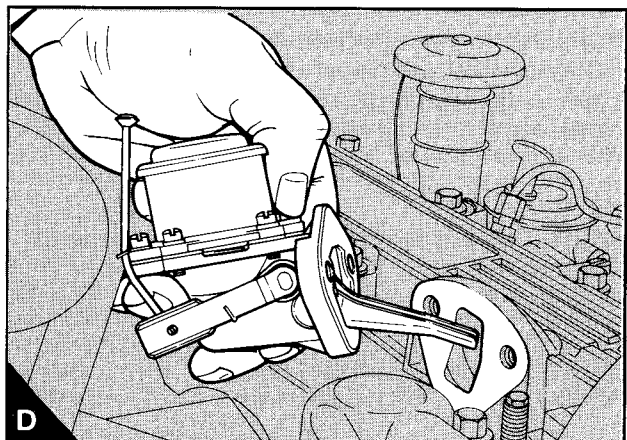

To dismantle and to assemble

20A-04

To dismantle

- 1 Clean the outside surfaces of the lift pump.
- 2 Make a mark across the flanges of the two halves of the pump to ensure correct relationship when the pump is assembled.
- 3 Remove the lift pump cover (A1) and the gauze strainer (A2). Release the screws and separate the two halves of the pump.
- 4 Turn the diaphragm assembly (A5) 90° to release the diaphragm pull rod from the link arm (A9) and remove the diaphragm assembly. Remove the stem seal (A7), the spring seat washer (A8) and the spring (A13) from the pull rod. The diaphragm and pull rod assembly is renewed as an assembly and no service is possible on the diaphragm.
- 5 The valves (A4) are peened in and can be removed with a suitable lever. Some of the peened metal will have to be removed before the valves can be removed.
- 6 To remove the link arm: Hold the rocker lever (A12) in a vice and hit the body of the lift pump with a soft face hammer to release the two retainers (A11). Be careful not to damage the joint face of the pump body. Remove the rocker lever, the pin (A10), the link arm and the return spring. Check the components for wear and other damage.

To assemble

- 1 Thoroughly clean the valve housings. Fit new seat washers (A3) and push the new valves (A4) into position. As the valves are the same, but one valve is fitted in reverse of the other, it is possible to fit the valves upside down. To ensure that the valves are correctly fitted, fit them as shown in A. When the valves are correctly fitted, peen the edge of the valve housings in six evenly divided places to keep the valves in position.
- 2 Fit the rocker lever (A12), pin (A10) and link arm assembly (A9) into the bottom half of the lift pump. Fit the return spring and ensure that the ends of the spring are in their correct locations.
- 3 With a light hammer and a suitable adaptor, fit two new retainers (A11) in their grooves in the casing until they fasten the pin. Peen the open ends of the grooves to fasten the retainers in position.
- 4 Fit the diaphragm spring (A13) into its location under the diaphragm (A5). Put the spring seat washer (A8) and a new stem seal (A7) into position on the pull rod. Ensure that the small diameter at the top of the seal is on the round section of the pull rod.
- 5 Put the diaphragm assembly in position over the lower half body with the blade of the pull rod aligned with the slot in the link arm. Ensure that the small protrusion on the edge of the diaphragm (B1) is at 90° to the similar protrusion on the body (B2). Press lightly down on the diaphragm until the notch in the pull rod is in the slot in the link arm. Turn the diaphragm 90° to ensure that the protrusion on the edge of the diaphragm aligns with the protrusion on the body. This action will engage and retain the pull rod in the slot of the link arm.
- 6 Push the rocker lever upwards until the diaphragm is level with the body flange. Fit the top half of the body in position with the marks on the flanges aligned. Keep the pressure on the rocker lever and fit the spring washers and the screws. Release the pressure on the rocker lever and tighten the screws evenly. When fitted, the edge of the diaphragm should be approximately level with the edge of the body.
- 7 Fit the gauze strainer (A2) and the cover (A1) with the rubber seal (A14) correctly fitted. Fit the cover screw and its sealing washer and tighten the screw.

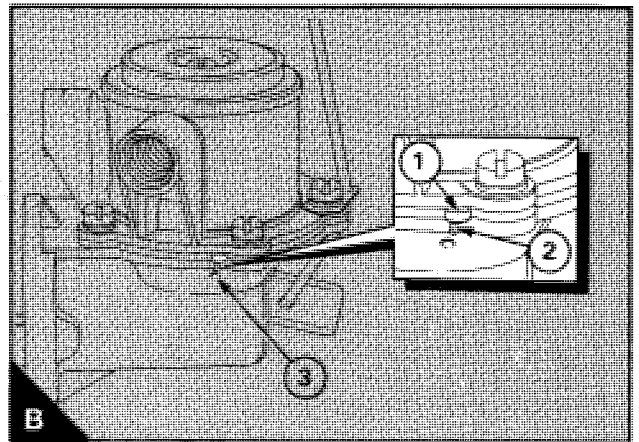
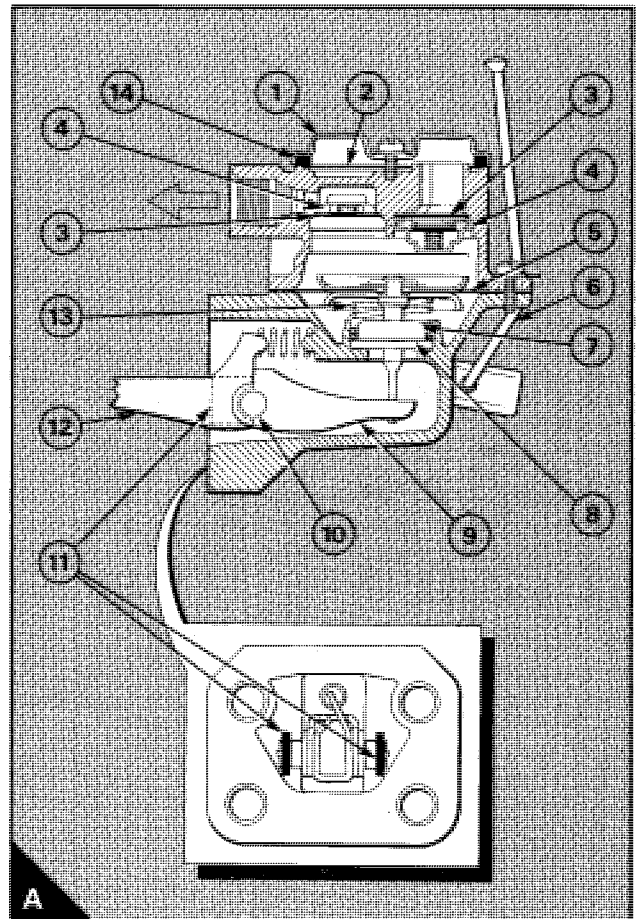

To test

20A-05

If there is a leakage of fuel through the hole in the pump body (20A.05/B3), this will indicate that the diaphragm is damaged. If there is a leakage of lubricating oil, the seal is damaged.

1 Disconnect the fuel outlet pipe from the fuel lift pump. Fit a 0-70 kPa (0-10 lbf/in²) 0-0,7 kgf/cm² pressure gauge to the outlet of the lift pump. Release the connection at the gauge and operate the priming lever of the lift pump to eliminate air from the pipe. When fuel, free of air, flows from the pipe tighten the connection. Ensure that there are no leaks at the connections between the pump and the gauge.

2 Operate the starter motor for 10 seconds and note the maximum pressure indicated on the gauge. If the pressure indicated is less than 75% of the minimum production static pressure shown in section 11C, correct or renew the pump. Also, after the crankshaft rotation has stopped, check the rate at which the pressure reduces to half the maximum pressure obtained. If this is less than 30 seconds, correct or renew the pump.

3 Remove the gauge and connect the outlet pipe to the lift pump. Release the vent screw on the fuel filter head and operate the priming lever until fuel, free of air, flows from the vent screw. Tighten the vent screw.

Fuel injection pump

To remove and to fit

20A-06

Special tools:

Timing pins, PD.182
 Location pins for fuel pump pulley, PD.190
 Pulley remover, PD.195
 Adaptors for use with PD.195, PD.195-1
 Anti-rotation tool, PD.203

- 1** Disconnect the battery.
- 2** Set number 1 piston to TDC compression stroke, operation 17A-01 and fit the timing pins PD.182. Remove the starter motor, operation 23B-01 and fit the anti-rotation tool PD.203 to the flywheel.
- 3** Remove the timing case cover, the timing belt and the toothed pulley for the fuel injection pump, see section 15.
- 4** Disconnect the speed control of the fuel pump and, if necessary disconnect the stop control. Disconnect the cables from the stop solenoid on the pump and, if necessary, the cold start advance unit and the cold idle solenoid. Ensure that the cables are suitably marked to ensure that they can be connected correctly.
- 5** Remove all necessary pipes from the pump. Ensure that a spanner is used to prevent movement of the fuel pump outlets (A) when the nuts of the high-pressure pipes are released.
- 6** Remove the setscrews which fasten the support bracket at the rear of the pump to the mounting bracket.
- 7** Remove the flange nuts and remove the pump (B) - ensure that the key does not fall from the drive shaft.

To fit

Attention: If a new or reconditioned pump is to be fitted, the pump shaft may be fastened in the equivalent position to the engine at number 1 piston at TDC compression stroke. If it is, the spacer in the shape of a pointer (C1) will be removed from under the setscrew which is fitted to the front left side of the pump. The spacer will be fastened loosely to the pump by a piece of wire. The pump can be fitted and the tension of the timing belt adjusted with the pump in this condition but **the pump shaft or the crankshaft must not be turned without the spacer in position under the setscrew.**

- 1** Ensure that the timing pins are fitted into the camshaft and into the flywheel. Ensure that the anti-rotation tool is fitted.
- 2** Ensure that the key is correctly fitted to the pump shaft. Put the fuel pump in position with the flange nuts tightened enough to hold the pump; but not enough to prevent radial movement of the pump body. Fit the setscrews which fasten the support bracket at the rear of the pump and tighten them finger tight.

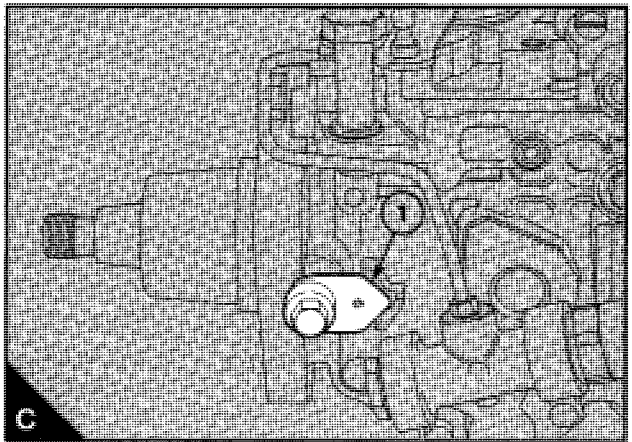
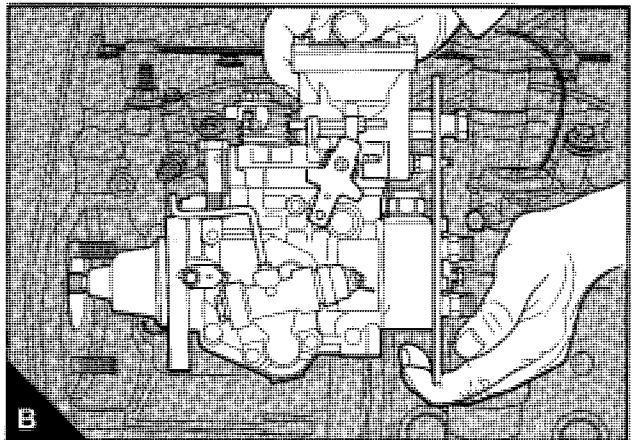
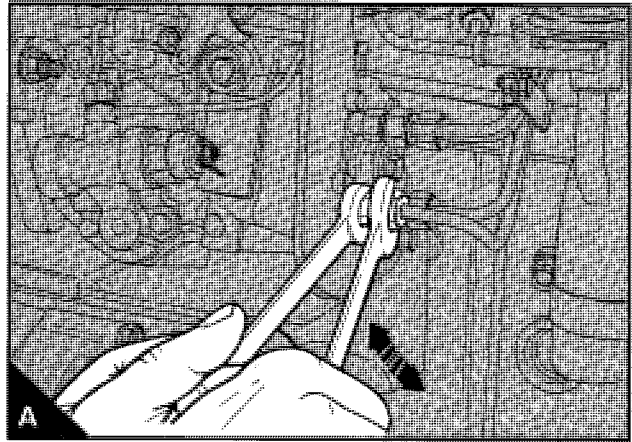

3 Put the toothed pulley on the shaft with the key engaged in the correct keyway, see operation 15A-05. Hold the pulley to prevent movement, fit the pulley nut and washer and tighten the nut to press the pulley onto the shaft; do not tighten the nut to its final torque.

4 If the shaft of the pump is fastened in the TDC position (see "Attention" above): Ensure that the correct marked tooth is towards the arrow on the timing case and fit the timing belt, see operation 15A-04. Check the position of the studs within the slots of the pump mounting flange; ensure that the fuel pump can move in a clockwise direction from the rear while the belt tension is adjusted. If there is not enough movement, change the belt position on the pulley. Adjust the tension of the timing belt, operation 15A-03. Ensure that the studs are not at the ends of the slots in the mounting flange of the pump and tighten the flange nuts. Loosen the setscrew on the side of the pump and fit the

spacer underneath. Tighten the setscrew to 12 Nm (9 lbf ft) 1,2 kgf m. Tighten the nut of the pump pulley to 60 Nm (44 lbf ft) 6,1 kgf m. Check the timing of the pump, operation 17A-03.

If the pump shaft is not fastened: Ensure that the correct marked tooth is towards the arrow on the timing case and fit the location pins through the plain holes in the pump pulley. Fit the timing belt, see operation 15A-04 and remove the location pins. Adjust the belt tension, operation 15A-03. Tighten the nut of the pump pulley to 60 Nm (44 lbf ft) 6,1 kgf m. Adjust the timing of the pump, operation 17A-03 and tighten the flange nuts of the pump.

5 Tighten the setscrews which fasten the support bracket at the rear of the pump to the mounting bracket.

6 Ensure that the timing pins are removed. Remove the anti-rotation tool and fit the starter motor, operation 23A-01.

7 Fit the timing case cover, operation 15A-01.

8 Fit the low-pressure pipes. Some pumps are fitted with a banjo connection bolt which is marked "OUT" and this must be fitted at the fuel return to tank connection.

9 Fit the high-pressure pipes to the pump. Ensure that a spanner is used to prevent movement of the fuel pump outlets when the high-pressure pipes are fitted. The relevant cylinders to which the pump outlets are to be connected are given in figure A. Do not tighten the connections at the atomisers until the air has been eliminated from the system.

10 Connect the speed control of the fuel pump and, if necessary, connect the stop control. Connect the cables from the stop solenoid on the pump. If necessary, connect the cold start advance unit and the cold idle solenoid. Connect the battery.

11 Eliminate air from the fuel system, operation 20A-10.

12 Operate the engine and check for leakage. Check that the idle speed is correct, operation 20A-07.

13 If a new fuel pump has been fitted, check the maximum no load speed, operation 20A-07.

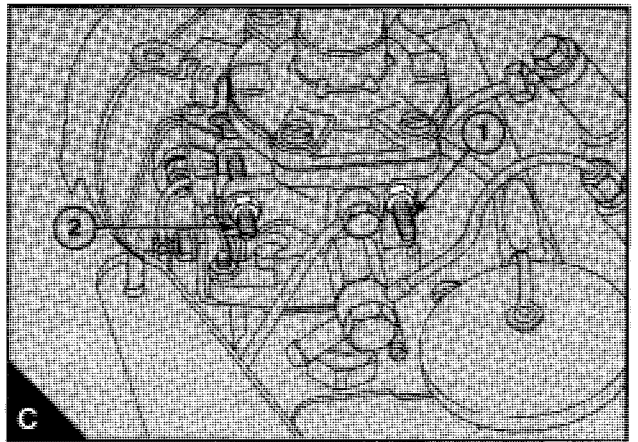
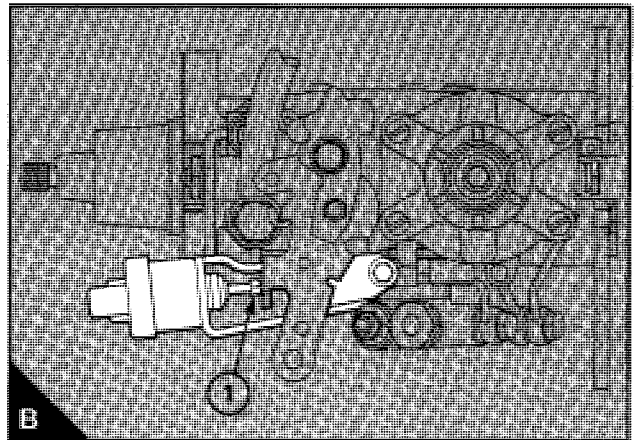
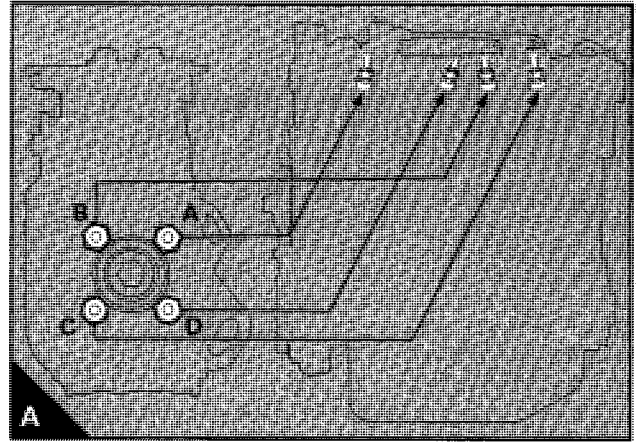

To adjust **20A-07**

1 If a cold idle solenoid (B) is fitted and the coolant temperature is below 30°C (86°F): Start the engine and check the cold idle speed which should be 1050 rev/min. If necessary, turn the hexagonal end of the plunger (B1) to adjust the speed. The idle speed should decrease automatically when the engine is warm.

2 For all engines: Operate the engine until it reaches its normal temperature of operation and check the idle speed. If necessary, adjustment can be made by the inner adjustment screw (C1). Release the locknut and turn the screw clockwise to increase or counter-clockwise to decrease the speed. When the speed is correct, tighten the locknut. The idle speed setting can change for different applications. The correct speed will normally be given in the application manufacturer's handbook. If it is not given, apply to your nearest Perkins distributor or to Technical Services Department, Perkins Power Sales and Service, Peterborough, England.

3 With the engine at its normal temperature of operation, check the maximum no load speed. The maximum no load speed is indicated by the last section of the fuel pump setting code. The setting code can be found on the data plate on the side of the fuel pump. A typical setting code is 2643H000CE/1/3200. In this example, the maximum no load speed is 3200 rev/min. If necessary, this speed can be adjusted by the outer adjustment screw (C2). Release the locknut and turn the screw counter-clockwise to increase or clockwise to decrease the speed. When the speed is correct, tighten the locknut and seal the screw. The person who fits the pump must ensure that the adjustment screw is suitably sealed against interference after it has been set initially.

The adjustment screw on original fuel pumps is set and sealed by the manufacturer. The setting must not be changed as this could affect the engine warranty.

To check the cold idle device

20A-08

This device is only fitted to certain vehicle engines.

Turn the electrical control switch to the "on" position.

If the engine coolant is cold - below 30°C (86°F):

The solenoid (A1) should be energised and the solenoid plunger should push against the control lever of the fuel injection pump. If the plunger does not move, connect a 12V supply directly to the solenoid terminal; if the plunger still does not move, renew the solenoid unit. If the plunger now moves, check the supply current at the temperature switch (A2) and the cable between the temperature switch and the solenoid. If these are correct, renew the temperature switch.

Attention: If the engine has run and is not yet completely cold, the temperature switch may not reset until the coolant temperature is at 20°C (58°F).

If the coolant is warm - above 30°C (86°F):

There should be no electrical supply at the solenoid (A1) and the end of the plunger should be away from the control lever of the fuel injection pump. If the solenoid is energised, renew the temperature switch (A2).

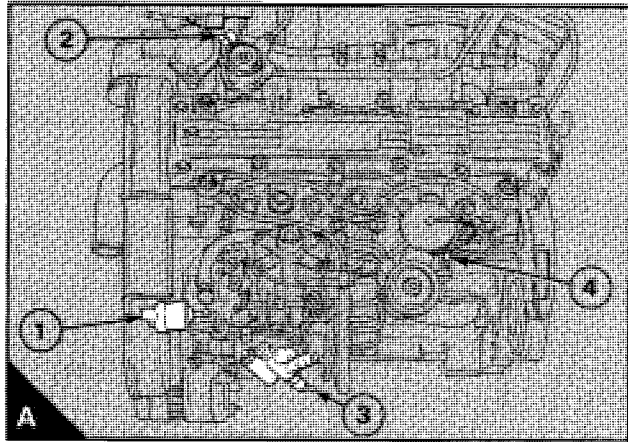

To check the cold start advance unit

20A-09

This unit can only be completely checked for correct operation on a test rig (for fuel injection pumps) or by the use of a dynamic timing tester (with the engine in operation). The unit can be renewed by a pump specialist.

If the engine is difficult to start or if there is a lot of white exhaust smoke when the engine starts: This could indicate that the unit has not changed the timing position for a cold start.

If the engine is noisy when warm or if the engine power is low: This could indicate that the unit has not allowed the timing to return to the normal position after a cold start.

To check the electrical supply to the unit, connect a 12V test lamp in the circuit at the advance unit connection (A3 or B1). Turn on the electrical supply at the control switch. Check the unit as follows:

Vehicle engines:

If the engine coolant is cold - below 30°C (86°F) for turbocharged engines or below 40°C (104°F) for naturally aspirated engines:

There should be no electrical supply at the unit (A3). If there is a supply, renew the temperature switch which is fitted at the rear of the cylinder head (A4).

Attention: If the engine has run and is not yet completely cold, the temperature switch may not reset until the coolant temperature is 10°C (18°F) below the temperatures given above.

If the engine coolant is warm - above 30°C (86°F) for turbocharged engines or above 40°C (104°F) for naturally aspirated engines:

There should be an electrical supply at the advance unit (A3). If there is not, check the supply at the temperature switch and the cable from the switch to the advance unit. If these are correct, renew the temperature switch (A4).

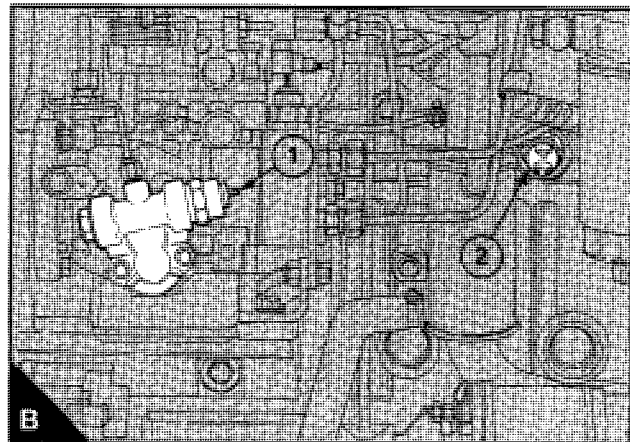

Turbocharged marine engines:

These units are not used on later engines.

If the engine coolant is cold - below 30°C (86°F):

There should be an electrical supply at the advance unit (B1). If there is not, check the supply at the temperature switch (B2) and check the cable from the switch to the advance unit. If these are correct, renew the temperature switch.

Attention: If the engine has run and is not yet completely cold, the temperature switch may not reset until the coolant temperature is at 20°C (68°F).

If the engine coolant is warm - above 30°C (86°F):

There should be no electrical supply at the unit (B1). If there is a supply, renew the temperature switch (B2).

Naturally aspirated marine engines:

If an advance unit is fitted, it is controlled by the heat of the fuel injection pump and is not checked electrically.

Fuel system**To eliminate air from the fuel system 20A-10**

If air enters the fuel system, it must be eliminated before the engine can be started.

Air can enter the system if:

- The fuel tank is drained during normal operation.
- The low-pressure fuel pipes are disconnected.
- A part of the low-pressure fuel system leaks during engine operation.

To eliminate air from the fuel system, proceed as follows:

- 1** Loosen, by two or three turns, the vent screw (A1) on the top of the fuel filter.
- 2** Operate the priming lever (B) on the fuel lift pump until fuel, free from air, comes from the filter vent point. Tighten the vent screw of the filter. If the drive cam of the fuel lift pump is at the point of maximum cam lift, it will not be possible to operate the priming lever. In this situation, the crankshaft must be turned one revolution.
- 3** Loosen the union nuts of the high-pressure pipes at the atomisers (C1). According to the type of atomiser fitted, the union nuts will be connected at the top or at the side of the atomiser.
- 4** Operate the starter motor until fuel, free from air, comes from the pipe connections. If a separate starter switch is used, ensure that the switch for the engine electrical system is in the "on" position for this operation.
- 5** Tighten the high-pressure pipe connections.
- 6** The engine is now ready to start.

If the engine runs correctly for a short time and then stops or runs roughly, check for air in the fuel system. If there is air in the fuel system, there is probably a leakage in the low pressure system.

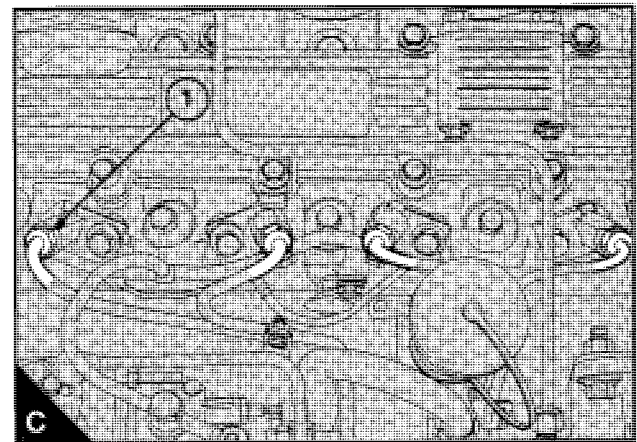
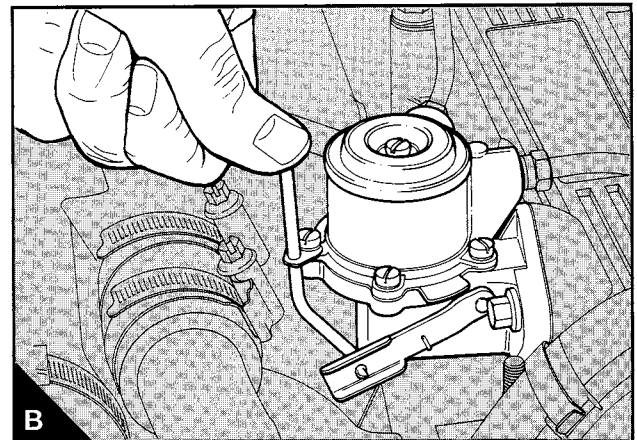
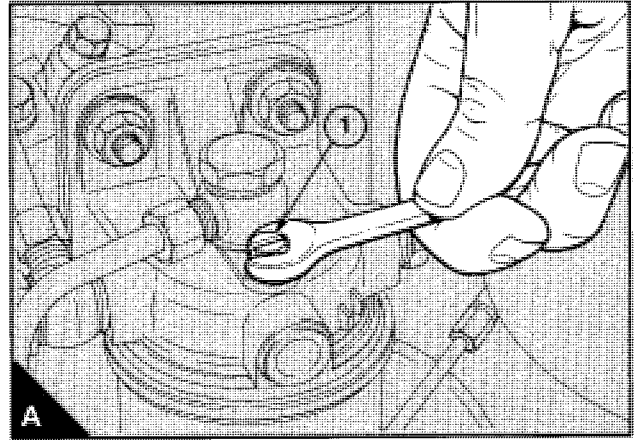



Cooling system

21

	General description	21A.02
	Coolant circuit (marine engines only)																			
21A-01	To drain	21A.03
21A-02	To fill	21A.03
	Raw water circuit (marine engines only)																			
21A-03	To drain	21A.03
	Thermostat																			
21A-04	To remove and to fit	21A.04
	To test	21A.04
	Water pump																			
21A-05	To remove and to fit	21A.05
	Raw water pump (marine engines only)																			
21A-06	To remove and to fit	21A.06
21A-07	To dismantle and to assemble	21A.06
	Mounting bracket and plate for the raw water pump																			
21A-08	To remove and to fit	21A.07
	Fan																			
21A-09	To remove and to fit	21A.08
	Fan drive (high position fans only)																			
21A-10	To remove and to fit	21A.08
	Lubricating oil cooler (marine engines only)																			
21A-11	To remove and to fit	21A.09
	Heat exchanger/manifold/header tank assembly																			
21A-12	To remove and to fit	21A.10
21A-13	To remove and to fit the tube stack of the heat exchanger	21A.11

General description

Non-marine engines:

Coolant from the bottom of the radiator passes through the centrifugal water pump which is fitted on the front of the cylinder block. The pump is belt driven from the crankshaft pulley and assists the flow of the coolant through the system. From the pump, the coolant passes directly into the front of the cylinder block.

The coolant then circulates around the cylinder block and cools the cylinders. From the cylinder block, the coolant passes to the cylinder head. Restriction holes in the cylinder head gasket ensure that the block and head are cooled evenly. The coolant passes out of the front right side of the head and into the thermostat housing. If the coolant is cold, it will pass through the by-pass in the thermostat housing and go directly into the inlet pipe of the water pump. As the temperature of the coolant increases, the thermostat valve will open, the by-pass will close and the coolant will pass to the radiator to be cooled.

Marine engines:

These engines have two cooling circuits. The closed circuit is filled with coolant which is used to cool the cylinder block and the cylinder head as for the non-marine engines above. This coolant is used also to cool the exhaust manifold. The raw water circuit uses raw water from outside the boat to cool the coolant of the closed circuit and to cool also the lubricating oil of M60 and M80T engines.

The heat exchanger, the exhaust manifold and the header tank for the closed circuit coolant are all together in one assembly. This is fitted to the right side of the engine.

The coolant in the closed circuit passes from the header tank to the inlet of the water pump. From the pump the coolant passes through the cylinder block and the cylinder head to the thermostat housing. If the coolant is cold, it passes through the by-pass, directly to the inlet of the water pump. As the temperature of the coolant increases, the thermostat valve will open, the by-pass will close and the coolant will pass to the heat exchanger. In the heat exchanger, the coolant passes around the tubes and is cooled by the raw water in the tubes. The coolant leaves the exchanger tubestack and enters the tank assembly where it cools the exhaust manifold which is an integral part of the assembly. The coolant then passes to the inlet of the water pump. For M60 and M80T engines, some coolant passes through an outlet at the rear of the assembly to an oil cooler and then to the pump inlet.

The raw water is circulated by the raw water pump which is fitted at the rear of the cylinder head and is driven from the rear end of the camshaft. From the pump, the raw water passes through the tubes of the heat exchanger and is then discharged into the exhaust.

Coolant circuit (marine engines only)

To drain 21A-01

Attention: Do not drain the coolant while the engine is still hot and the system is under pressure because dangerous hot coolant can be discharged.

- 1 Remove the filler cap from the coolant header tank.
- 2 Remove the drain plug (A1) from the right side of the cylinder block to drain the engine. Ensure that the drain hole is not restricted.
- 3 Remove the drain plug (A2) at the bottom of the heat exchanger/manifold/header tank assembly to drain the assembly. Ensure that the drain hole is not restricted.
- 4 Remove the drain plug (A3) from the inlet of the engine oil cooler (if one is fitted). Ensure that the drain hole is not restricted.
- 5 Fit the drain plugs and the filler cap.
- 6 Fasten a suitable label to the engine control panel to indicate that the coolant has been drained.

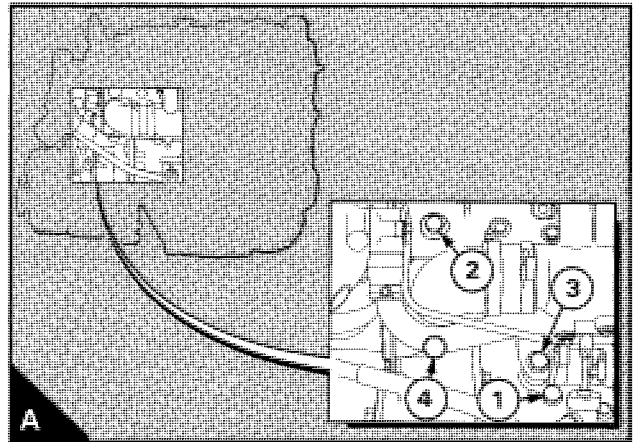

To fill 21A-02

See "Coolant specification" in section 5 of the handbook for details of the correct coolant to be used in the circuit.

- 1 Remove the vent plug from the water outlet connection (B1) or from the top of the heat exchanger/manifold assembly (B2).
- 2 Remove the filler cap (B3) of the header tank and fill the tank until the coolant level reaches the filler tube.
- 3 Fit the vent plug and the filler cap.
- 4 Start the engine and, when it has reached its normal temperature of operation, stop it and let it cool.
- 5 Remove the filler cap of the header tank and add coolant until the level of the coolant reaches the filler tube. Fit the filler cap.

Attention: If coolant is added to the circuit during service, it must consist of the same original mixture as used to fill the system.

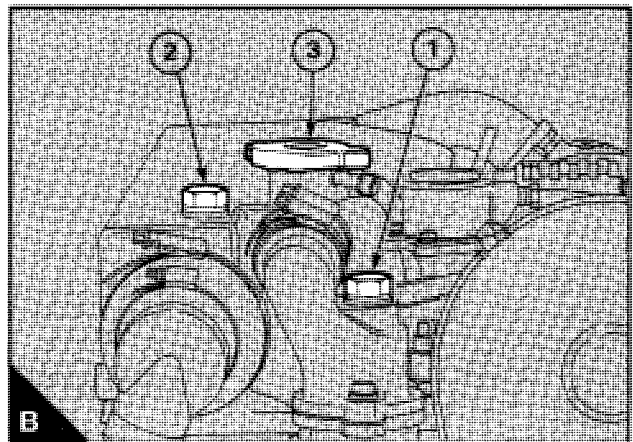

Raw water circuit (marine engines only)

To drain 21A-03

- 1 Ensure that the seacock is closed.
- 2 Disconnect both hoses at the raw water pump.
- 3 Remove the drain plug (A4) from the outlet pipe of the heat exchanger. Ensure that the drain hole is not restricted.
- 4 Turn the engine to ensure that the raw water pump is empty.
- 5 Connect the pipes and fit the drain plug.

Thermostat

To remove and to fit

21A-04

To remove

- 1 Drain the cooling system so that the coolant level is below the thermostat position and disconnect the top hose from the coolant outlet connection.
- 2 Release the setscrews and remove the coolant outlet connection (A1).
- 3 Remove the thermostat (A2).

To fit

- 1 Ensure that the joint faces of the housing and the outlet are clean and that the jiggle pin (A3) in the thermostat is free to move.
- 2 Put the new thermostat in position in the housing.
- 3 Fit a new joint and the coolant outlet connection and tighten the setscrews.
- 4 Connect the top hose and fill the cooling system with the correct coolant, see the relevant handbook.

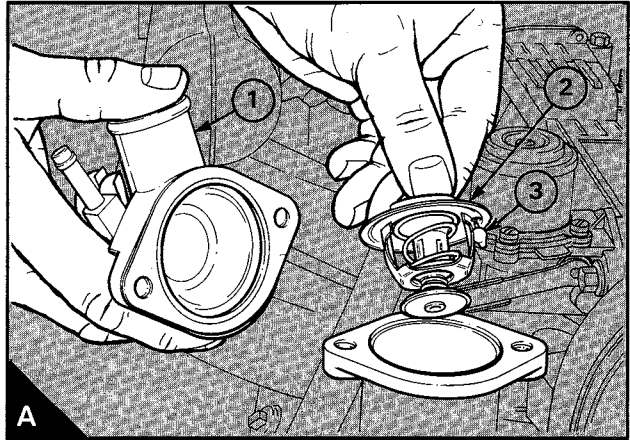

To test

- 1 Hang the thermostat in a suitable container filled with water.
- 2 Heat the water gradually. Use a thermometer to check the temperature at which the valve starts to open and at which it is fully open. The correct temperatures are given in section 11C.
- 3 If the thermostat does not operate correctly, it must be renewed. Do not try to adjust the settings.

Water pump

To remove and to fit

21A-05

Attention: the engine mounting is an integral part of the water pump for some vehicle engines. A support will have to be provided for the engine or the engine will have to be removed before the water pump is removed.

To remove

- 1 Disconnect the battery.
- 2 Drain the cooling system.

Marine engines: Drain the coolant circuit, operation 21A-01.

3 Disconnect the inlet pipe at the water pump and, if necessary, disconnect the by-pass connection.

4 Set number 1 piston to TDC compression stroke, operation 17A-01 and fit the timing pins.

5 Remove the timing case cover, operation 15A-01 and the timing belt, operation 15A-04. For later vehicle engines it is only necessary to hold the toothed pulley for the fuel injection pump with the special pins (see operation 15A-04) and remove the tensioner pulley and the idler pulley. Disconnect the hose connections, remove the pump setscrews and remove the pump (A).

6 For certain vehicle engines, remove the two setscrews which fasten the plate for the timing case (B1) and remove the plate. Remove the setscrew which fastens the side of the timing case to the pump (B2). Remove the pump setscrews and remove the pump.

For other engines, remove the timing case, operation 15A.08. Remove the pump setscrews and remove the pump (C).

To fit

1 Check the pump for wear and other damage. If there is a fault, the pump must be renewed as an assembly.

2 Ensure that the contact faces of the water pump and of the cylinder block are clean.

3 Apply a 1,0/1,5 mm (0.04/0.06 in) continuous bead of POWERPART Sealant (Loctite 518) to the contact face of the pump, on the impeller side of the fastener holes (D1). If the old setscrews are to be used, clean the thread of the setscrew which will be fitted in the 10 o'clock position (C1) and apply sealant to the thread. Immediately after the sealant has been applied to the pump, put the pump in position and fit the setscrews. If necessary, also fit the plate for the timing case (B1). Tighten the setscrews gradually and evenly to the correct torque, see section 11B. If necessary, fit the setscrew which fastens the timing case to the pump (A2).

Attention: The threaded holes in the cylinder block for the water pump setscrews have been changed from M8 to M10, except for hole C1. The latest pump, with the larger holes, will be supplied as a spare part for both earlier and later engines. A sleeve is supplied with the pump to reduce the diameter of one of the holes for location purposes when the pump is used on earlier engines. This sleeve should be fitted in the hole opposite to the hole which will align with the threaded hole C1.

4 If necessary, fit the timing case and the toothed pulleys, see section 15. Fit the timing belt, operation 15A-04, and adjust the belt tension, operation 15A-03. Check the timing of the fuel injection pump, operation 17A-03.

5 **Ensure that the timing pins are removed** and fit the setscrew in the timing hole in the top of the camshaft cover. Fit the timing case cover, operation 15A-01.

6 Connect the hose to the pump inlet connection and, if necessary, connect the by-pass connection. Fill the cooling system with the correct coolant; see the relevant handbook.

Marine engines: Fill the coolant circuit, operation 21A-02.

7 Connect the battery. Operate the engine and check for leakage.

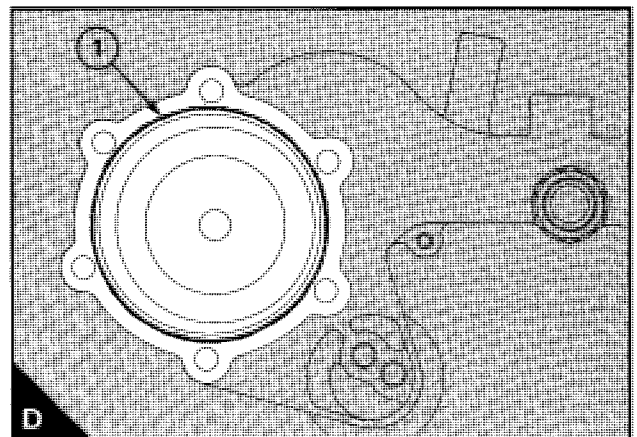
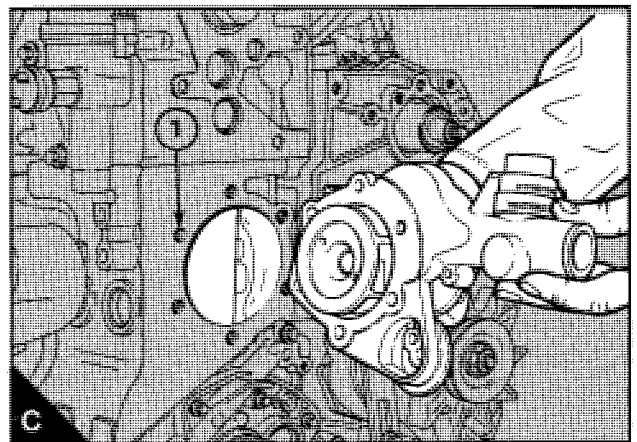
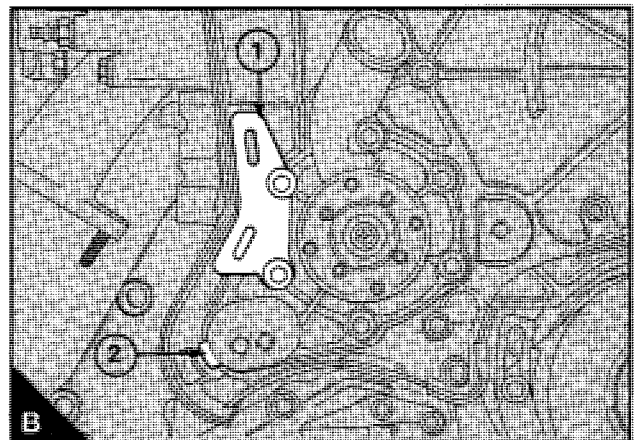
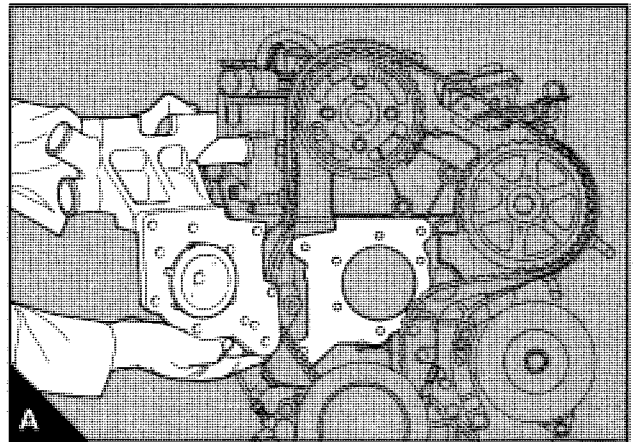

Raw water pump (marine engines only)

To remove and to fit

21A-06

Attention: If the mounting bracket and the mounting plate for the raw water pump are released, they must be aligned correctly (with the use of an alignment tool) before the pump is fitted, see operation 21A-08.

- 1 Drain the raw water circuit, operation 21A-03.
- 2 Disconnect the hose connections at the pump.
- 3 Release the four setscrews which fasten the pump to its drive housing and remove the pump (A).
- 4 Clean the contact surfaces of the pump body and the adaptor plate.
- 5 Clean and inspect for wear the drive components of the pump. If necessary, renew the worn components or the pump. If the drive adaptor is removed from the end of the camshaft, tighten the adaptor cap screws to 9 Nm (7 lbf ft) 0,9 kgf m when the adaptor is fitted.
- 6 Apply a high melting point grease (for example Shell Alvania R2) to the drive components and to fill the inside of the drive housing.
- 7 Align the slot in the pump shaft (A1) with the projection on the drive shaft (A2). Fit the pump to the engine with a new joint between the pump and the adaptor plate. Fit the setscrews and tighten them to 9 Nm (7 lbf ft) 0,9 kgf m.
- 8 Connect the hose connections at the pump.
- 9 If necessary, open the seacock.

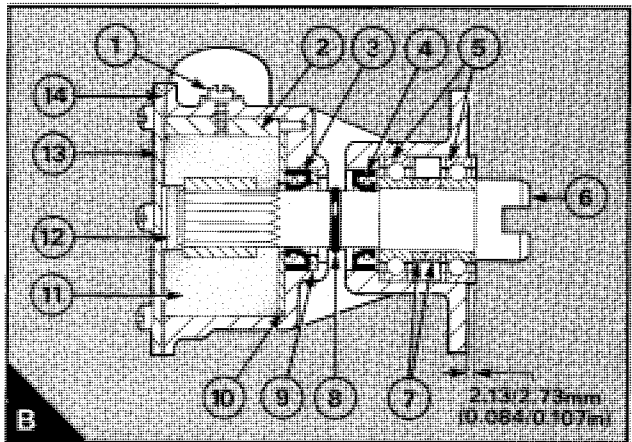
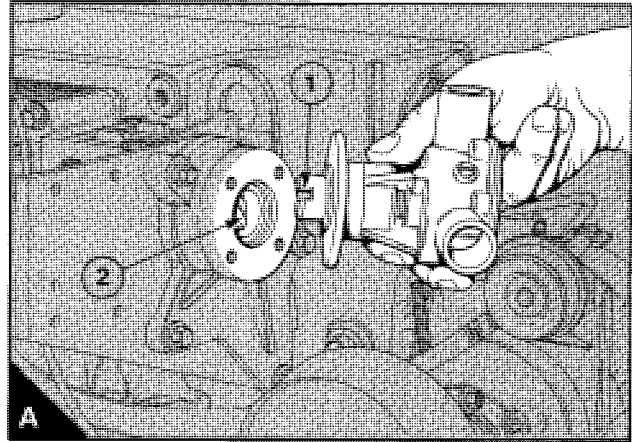

To dismantle and to assemble

21A-07

To dismantle

- 1 Remove the pump, operation 21A-06.
- 2 Remove the end cover (B13) and its joint (B14).
- 3 Remove the rubber plug (B12) from the end of the impeller (B11).
- 4 Remove carefully the impeller from the shaft (B6) with suitable levers or with long nose pliers.
- 5 Press out the shaft and bearing assembly through the drive end of the housing with the use of a suitable adaptor. If the bearings (B5) and their spacers (B7) do not come out with the shaft, they can be pressed out later when the impeller seal (B3) has been removed. Do not lose the "O" ring (B8) when the shaft is removed.
- 6 Release the cam plate screw (B1) by two or three turns and lightly hit the top of the screw to separate the cam plate (B2) from the body. Remove the screw and the cam plate.
- 7 Remove the wear ring (B10), the seal (B3) and the seal spacer (B9) from the impeller housing.
- 8 Remove the seal (B4) from the bearing housing.
- 9 Check the components for wear and other damage and renew them, if necessary. Renew the seals and the joint.

To assemble

- 1 Ensure that all the components are clean.
- 2 Press one of the bearings (B5) on to the shaft (B6), fit the spacers (B7) and then press on the other bearing. Use an adaptor that will contact the inner flange of the bearing to press on the bearings. The bearings are lubricated for life.
- 3 Press one of the seals (B4) into position in the bearing housing with the lip towards the drive end. Lightly lubricate the lip of the seal.

4 Support the pump on the cover end and press the shaft and bearing assembly into the bearing housing. When the assembly has been correctly pressed in, the outside bearing will have a protrusion of 2,13/2,73 mm (0.084/0.107 in) from the mounting face.

5 Slide the "O" ring (B8) along the shaft until it is in the centre of the space between the bearing housing and the impeller housing.

6 Fit the seal spacer (B9) into the seal housing. Lightly lubricate the lip of the other seal (B3) and press it into position in the impeller housing with the lip towards the impeller position.

7 Put the wear plate (B10) in position in the impeller housing with the dowel in its location. If the plate is worn on one face, fit it with the face which is not worn towards the impeller.

8 Apply a suitable jointing compound to the top face and to the front (wear plate) face of the cam plate (B2). Also apply jointing compound to the thread of the screw (B1) for the cam plate. Fit the cam plate and tighten the screw.

9 Apply Marfak 2HD grease to the blades of the impeller (B11) and fit it on the shaft with the blades bent clockwise (as seen from the cover end). If the blades are slightly worn, the impeller can be fitted with its original front end to the rear. Fit the rubber plug (B12) in the end of the impeller.

10 Apply jointing compound to a new joint (B14). Fit the joint, the end cover (B13) and the screws. Tighten the screws gradually and evenly.

Mounting bracket and plate for the raw water pump

To remove and to fit

21A-08

Special tool:

Alignment adaptor for raw water pump mounting, PD.207

- 1** Remove the raw water pump, operation 21A-06 and remove the adaptor plate.
- 2** Disconnect the fuel pipes at the fuel filter and, if necessary, remove the filter.
- 3** Release the four setscrews and remove the mounting plate and the bracket.
- 4** Check the bracket and the plate for cracks and other damage.
- 5** Release the cap screws and remove the drive adaptor from the end of the camshaft.
- 6** Put the mounting bracket and plate in position, engage the setscrews and tighten them finger tight only.
- 7** Engage the small diameter of the alignment tool (A1) into the end of the camshaft and the larger diameter into the bore of the mounting plate. Tighten the setscrews gradually and evenly and remove the alignment tool.
- 8** Fit the drive adaptor in the end of the camshaft and tighten the cap screws to 9 Nm (7 lbf ft) 0,9 kgf m.
- 9** Fit the raw water pump, operation 21A-06.

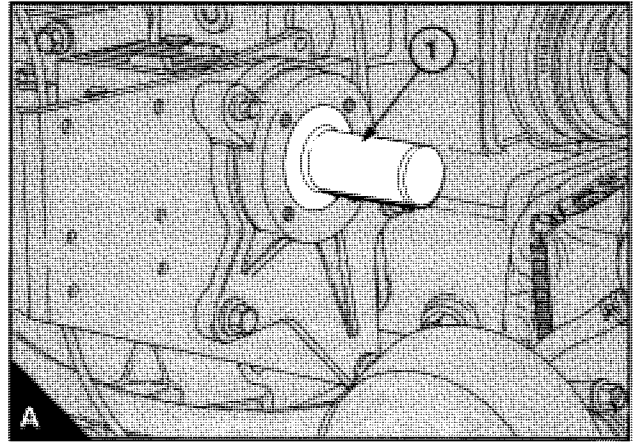

Fan

To remove and to fit

21A-09

To remove

- 1 Release the tension of the drive belt, see operation 23A-02.
- 2 Release the setscrews and remove the fan. If necessary, fit the setscrews to retain the fan extension and the pulley to the hub.

To fit

- 1 If necessary, release the setscrews from the hub of the fan drive. Fit the fan and the setscrews and tighten the setscrews to 9 Nm (7 lbf ft) 0,9 kgf m.
- 2 Fit the drive belt for the alternator and adjust the belt tension, operation 23A-02.

Fan drive (high position fans only)

To remove and to fit

21A-10

Special tool:

Belt tension gauge, J.23600-B

- 1 Loosen the centre setscrew of the tensioner pulley (A4) and release the tension on the drive belt for the fan.
- 2 Remove the fan and its drive belt.
- 3 Remove the bottom setscrew (A9) and its spacer which fasten the fan drive bracket (A10) to the front of the cylinder head. On later engines, a cap screw and washer are fitted instead of a setscrew.

4 If the assembly is to be removed for access to the front cover: Remove the three setscrews (A11) which fasten the front bracket to the top bracket (A1) and remove the fan drive assembly.

If the complete assembly is to be removed: Remove the two setscrews (A2) which fasten the top bracket to the cylinder head setscrews and remove the drive assembly.

5 Ensure that all components are clean. Check the components for wear and for damage and renew them, if necessary. The fan drive pulley and its bearing and shaft assembly must not be removed from the mounting plate; the complete assembly must be renewed, if necessary.

6 If the extension nuts (A3) have been removed, fit them to the cylinder head setscrews with the counterbores downwards; tighten them to 43 Nm (32 lbf ft) 4,4 kgf m.

7 If necessary, fit the mounting bracket to the extension nuts and tighten the two setscrews to 43 Nm (32 lbf ft) 4,4 kgf m. On some engines, washers are fitted with the two setscrews for the top mounting bracket. On these engines the washers must be fitted between the extension nuts and the mounting bracket.

8 If necessary, fit the mounting plate to the bracket, fit a setscrew in the centre hole of the three top holes and tighten it finger tight

9 Ensure that the hole in the mounting plate for fastener A9 aligns with the threaded hole in the cylinder head. Fit the spacer between the mounting plate and the cylinder head and fit the setscrew or the cap screw and washer. Tighten the setscrew to 22 Nm (16 lbf ft) 2,2 kgf m or tighten the cap screw to 39 Nm (29 lbf ft) 4,0 kgf m.

10 Fit the other two setscrews in their holes at the top of the plate and tighten all three setscrews to 43 Nm (32 lbf ft) 4,4 kgf m.

11 If necessary, fit the tensioner pulley to the mounting plate. Fit the shoulder nut (A7) inside the slot in the mounting plate and fit the spacer (A6) over the front of the nut. Assemble the collar (A8) and the pulley/bearing assembly (A5). Ensure that the flange of the collar is on the opposite side to the flange in the pulley which retains the bearing. Fit the assembly to the mounting plate with the collar flange to the front, engage the setscrew and tighten it finger tight.

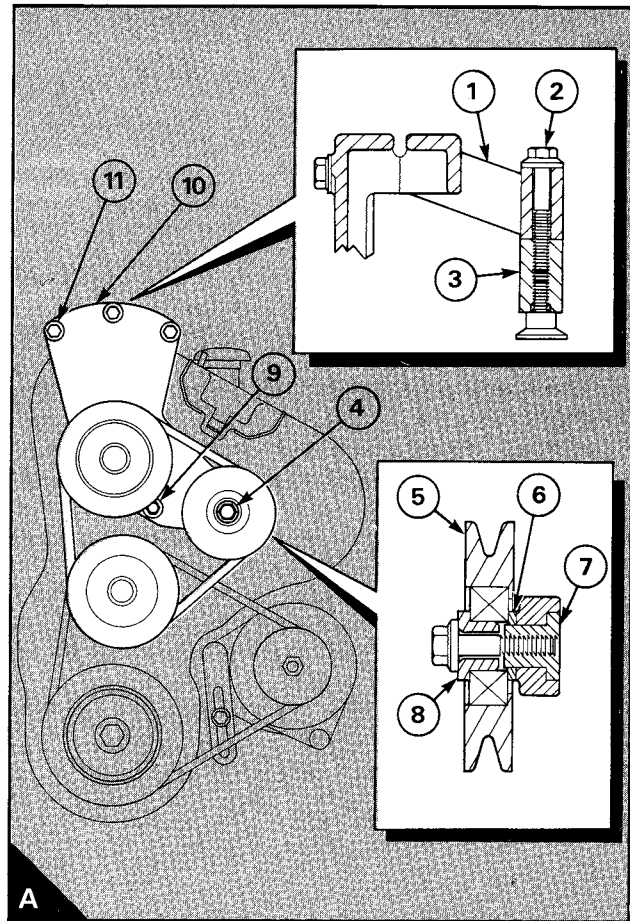

- 12 Fit the fan drive belt and the fan. Move the tensioner pulley with a wooden wedge or a wooden lever to get the correct tension and tighten the pulley setscrew to 43 Nm (32 lbf ft) 4,4 kgf m. Ensure that the tension is still correct. The correct tension is 80 lbf if the tension gauge is used. If the tension gauge is not available, press down the belt with the thumb at the centre of the longest free length and check the deflection. With moderate thumb pressure, 45 N (10 lbf) 4,5 kgf, the correct deflection of the belt is 6 mm (1/4 in).

Lubricating oil cooler (marine engines only)

To remove and to fit

21A-11

The tubes in the cooler will not normally need to be cleaned as the coolant which goes through them is from the closed coolant circuit.

- 1 Drain the coolant circuit, operation 21A-01.
- 2 Disconnect the coolant pipes at the cooler
- 3 Disconnect the lubricating oil pipes at the cooler.
- 4 Make a suitable mark on the body and on the strap (A1) to indicate the correct position for the strap.
- 5 If the cooler only is to be removed: Release the three setscrews which fasten the strap to the cooler and remove the strap and the cooler (A) from the bracket.

If the cooler and bracket assembly are to be removed: Remove the setscrew and the spacer which fasten the bracket for the sump drain pump. Release the two setscrews which fasten the cooler bracket to the cylinder block and remove the cooler together with its bracket and strap.

- 6 Check the components for damage and renew them, if necessary.

7 If the cooler and bracket assembly have been removed: Put it in position and engage the two front setscrews. Engage the rear setscrew through the bracket of the drain pump and the spacer and into the cylinder block. Ensure that the cooler body is in the correct position. Tighten the front setscrews to 22 Nm (16 lbf ft) 2,2 kgf m and the rear setscrew to 43 Nm (32 lbf ft) 4,3 kgf m.

If the cooler only has been removed: Put it into its correct position, fit the strap and tighten the three setscrews for the strap to 22 Nm (16 lbf ft) 2,2 kgf m.

- 8 Connect the coolant hoses and the oil pipes.
- 9 Fill the coolant system, operation 21A-02.
- 10 Operate the engine and check for leakage of coolant and lubricating oil.

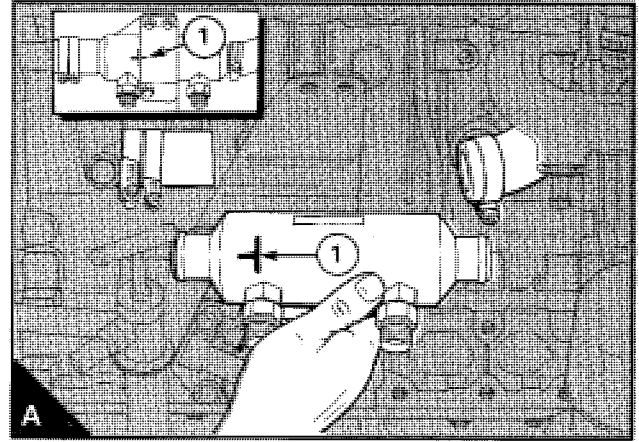

Heat exchanger/manifold/header tank assembly

To remove and to fit

21A-12

Attention: For later assemblies, a long stud is fitted at each end of the bottom line of fasteners. These studs are used for location purposes instead of the dowels (A1) which were fitted to earlier engines. A side clearance of at least 135mm (5.3 in) is necessary to slide the assembly off these studs. If this clearance is not available, it may be possible to slide the assembly along the studs and a suitable tool used to get a grip on the studs and to remove them. A support must be provided for the assembly while the studs are removed. The reverse procedure can be used to fit the assembly.

1 Drain the coolant circuit, operation 21A-01 and the raw water circuit, operation 21A-03.

2 Turbocharged engines: Remove the turbocharger, operation 18A-02 and the oil supply pipe for the turbocharger.

3 Release the support clips which fasten the outlet pipe of the heat exchanger to the bottom of the induction manifold. Remove the induction manifold.

4 Disconnect the inlet and the outlet pipes for the raw water of the heat exchanger.

5 Release the flange setscrews of the coolant pipe(s) which is/are fitted to the bottom of the assembly and release the pipe(s) from the assembly.

6 Remove the support bracket which is fitted between the rear of the assembly and the adaptor housing for the reverse gearbox.

7 Release evenly and gradually the setscrews which fasten the assembly to the cylinder head, in the reverse sequence to that shown in B. Remove the assembly (A).

8 Remove the joints and clean the contact faces of the assembly, the cylinder head and the flange(s) of the coolant pipe(s). Check the components for damage and renew them, if necessary. If the tube stack is to be removed, see operation 21A-13.

9 Put a new manifold joint in position over the dowels in the cylinder head (A1) of earlier engines or over the two location studs of later engines. If a new assembly (with no location holes for the dowels A1) is to be fitted to an earlier engine, remove the dowels from the cylinder head. It is not necessary to use a jointing compound. Ensure that the joint is fitted correctly, as shown in 18A.03/B.

10 Put the assembly in position on the cylinder head and engage the setscrews or nuts. Tighten the setscrews or nuts evenly and gradually to 22 Nm (16 lbf ft) 2,2 kgf m, in the sequence shown in B.

11 Fit the support bracket between the rear of the assembly and the flywheel housing.

12 Fit the coolant pipe(s) to the bottom of the assembly, together with new joint(s).

13 Connect the inlet and the outlet pipes for the raw water of the heat exchanger. The end of the outlet pipe should reach the centre of the end cap.

14 Fit the induction manifold, together with new joints and tighten the setscrews to 22 Nm (16 lbf ft) 2,2 kgf m.

15 Turbocharged engines: Fit the turbocharger, operation 18A-02 and the oil supply pipe for the turbocharger.

16 Fit the support clips which fasten the outlet pipe of the heat exchanger and the oil supply pipe for the turbocharger to the induction manifold.

17 Fill the coolant circuit, operation 21A-02 and open the seacock.

18 Operate the engine and check for leaks.

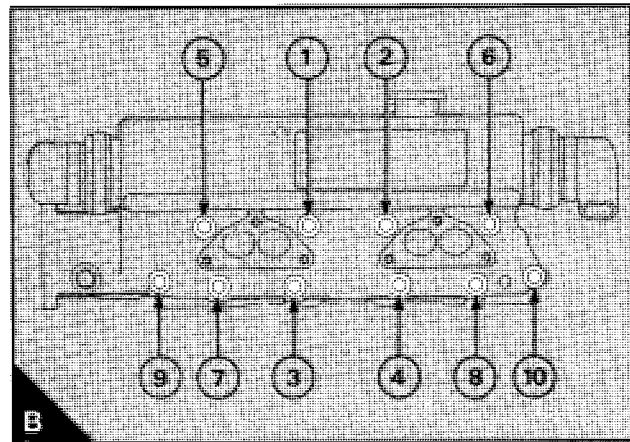
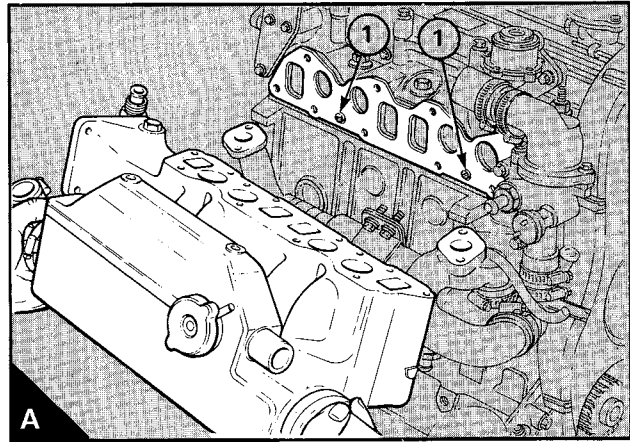

To remove and to fit the tube stack of the heat exchanger

21A-13

The tube stack can be removed (with the heat exchanger in position) if there is 555 mm (22 in) clearance directly to the front or the rear of the face of the header tank.

- 1 Drain the coolant circuit, operation 21A-01 and the raw water circuit, operation 21A-03.
- 2 Release the support clips which fasten the outlet pipe of the heat exchanger to the bottom of the inlet manifold. Disconnect the outlet pipe.
- 3 Loosen the clips of the neoprene end caps and remove the caps.
- 4 Press the tube stack out through either end of the heat exchanger. Ensure that the sleeve (A1) is removed from the body.
- 5 Ensure that the bores of the tubes are clean. If there are hard deposits or debris in the tubes, the best method to clean them is to use a non-caustic solution which is approved by the manufacturer. If the deposits or the debris are soft, the tubes can be cleaned with a steel rod of 3 mm (1/8 in) diameter. Push the rod through the tubes in the opposite direction to the water flow. Ensure that the rod does not damage the tubes.
- 6 Check the components for damage and renew them, if necessary.
- 7 Slide the sleeve (A1) onto one end of the tube stack until the end of the tube stack is in contact with the reduced diameter in the sleeve.
- 8 Push an end cap (A2) over the other end of the tube stack until the protrusion on the inside of the cap is in contact with the end of the tube stack.
- 9 If a rubber sleeve is used, lubricate it with a little soft soap. Put the sleeve end of the assembly into the housing and carefully enter the sleeve into the hole in the baffle plate. Carefully push the tube stack through the housing and through the opening in the other end of the housing until the spigot of the housing is correctly fitted inside the end cap. Do not pull the tube stack backward during the assembly operation as this will remove the sleeve from the baffle plate. Check through the filler cap aperture to ensure that the sleeve is correctly fitted in the baffle plate (B).
- 10 Fit the other end cap, ensure that the pipe connections of the end caps are in their correct positions and tighten the clips. If the assembly has been removed from the engine, put the caps in the positions shown in C.
- 11 Fit the inlet and outlet pipes and tighten the hose clips. The end of the outlet pipe should reach to the centre of the cap. Tighten the support clips of the outlet pipe.
- 12 Fill the coolant circuit, operation 21A-02 and open the seacock.
- 13 Operate the engine and check for leaks.

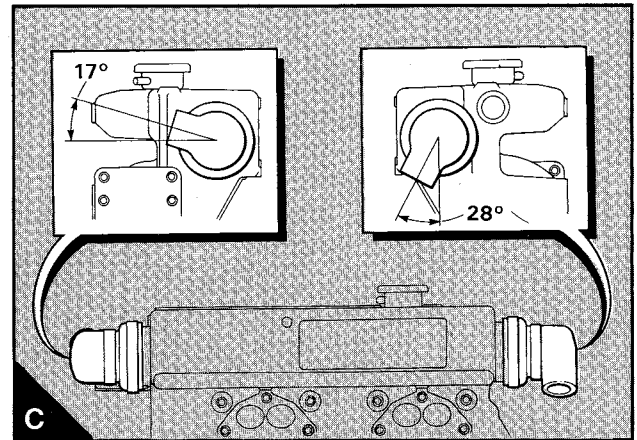
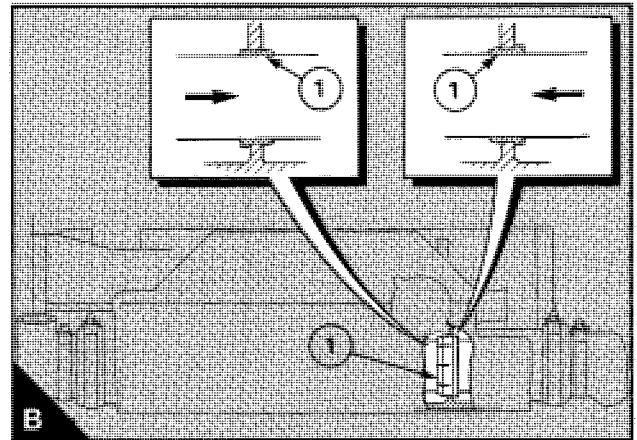
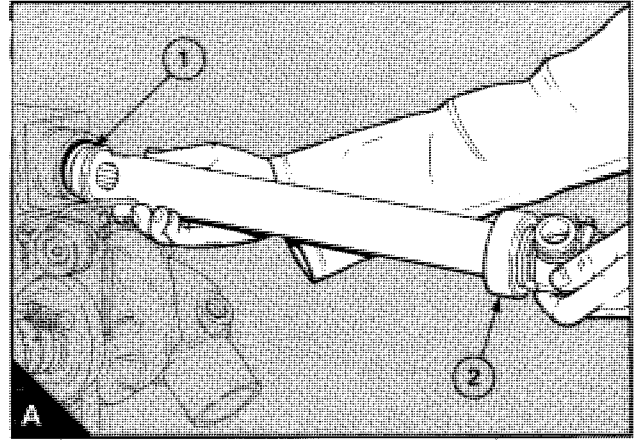

)

)

)

)

General description

The engine may be fitted with an aluminium or mild steel backplate or a cast iron flywheel housing. Marine engines have an aluminium adaptor housing fitted between the backplate and the reverse gearbox.

The steel flywheel has a hardened starter ring which is expansion fitted. The starter ring fitted to industrial and marine engines has 104 teeth and the ring fitted to vehicle engines has 100 or 115 teeth.

The reverse gearbox which is fitted in the factory for marine engines is a Hurth HBW10 or HBW250.

Flywheel

To remove and to fit

22A-01

To remove

- 1 Remove the drive components from the rear of the engine.
Marine engines: Remove the gearbox adaptor housing and remove the flexible drive plate from the flywheel.
- 2 Remove two opposite setscrews from the flywheel and fit temporarily two guide studs to ensure safety when the flywheel is removed and fitted.
- 3 Remove the remainder of the setscrews and remove the flywheel.
- 4 Check the flywheel and the ring gear for damage and renew, if necessary.

To fit

- 1 Ensure that the location faces of the crankshaft and of the flywheel are clean and free from damage.
- 2 Ensure that the dowel is fitted in the flange of the crankshaft. Fit the flywheel over the guide studs. Fit four setscrews, remove the guide studs and fit the other two setscrews. Tighten the setscrews gradually and evenly to 65 Nm (48 lbf ft) 6,6 kgf m.
- 3 Check the flywheel run-out with a dial test indicator (A). This must be less than 0,30 mm (0.012 in) total indicator reading.
- 4 Check the alignment of the flywheel face (B). The alignment error must be not more than 0,03 mm (0.001 in) total indicator reading for every 25 mm (1.0 in) of the flywheel radius (from the crankshaft axis to the indicator plunger). During this check, keep the crankshaft pressed towards the front to remove the effect of crankshaft end-float.
- 5 Marine engines: Fit the flexible plate for the gearbox drive (C). Apply POWERPART Studlock to the threads of the plate setscrews. Ensure that the small location diameter of each setscrew enters the flywheel (C1). Tighten the setscrews gradually and evenly to 9 Nm (7 lbf ft) 0,9 kgf m. Do not start the engine until the locking agent has had time to harden.
- 6 Fit the drive components to the rear of the engine.

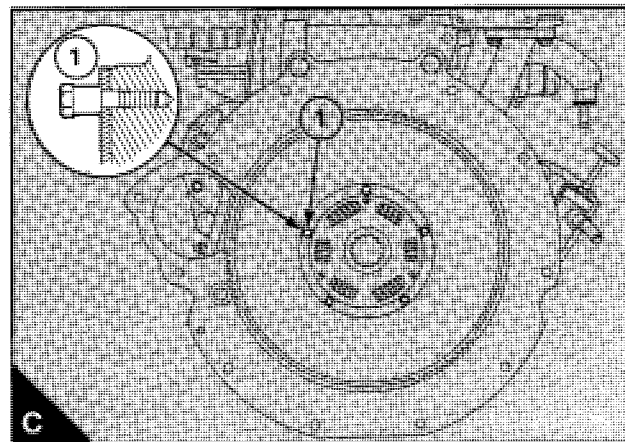
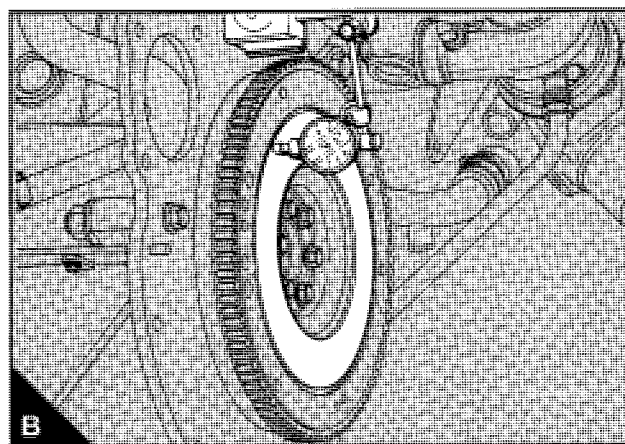
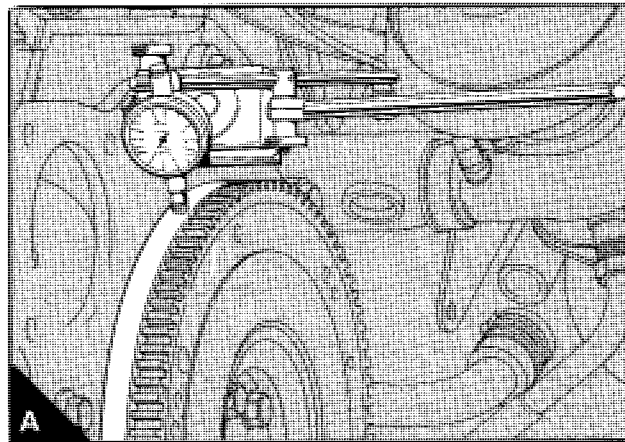

Ring gear

To remove and to fit

22A-02

To remove



For this operation eye protection must be used.

Before the ring gear is removed, check the position of the chamfer on the teeth.

The ring gear can be removed with a hammer and a chisel to break the ring. Ensure that the flywheel is not damaged during this operation.

To fit

The ring gear is heated onto the flywheel. When a new gear is to be fitted, ensure that it is not heated to more than 250°C (480°F). Ensure that the chamfer on the teeth of the gear is in the correct direction.

Flywheel housing or backplate

To remove and to fit

22A-03

To remove

- 1 Remove the drive components from the rear of the engine.
- 2 Remove the starter motor, operation 23B-01.

Marine engines: Remove the adaptor housing for the gearbox. Before the adaptor housing is removed, the turbocharger drain pipe (if fitted) must be disconnected and the support plate for the manifold must be removed.

- 3 Remove the flywheel, operation 22A-01.
- 4 Release the setscrews of the flywheel housing or the backplate. Use a soft face hammer to remove it from the dowels.

To fit

Special tools:

Protection sleeve PD.191

Replacer for crankshaft rear seal PD.550-1

- 1 Ensure that the rear face of the cylinder block and the faces of the flywheel housing or backplate are clean and free from damage.
- 2 Where the rear seal for the crankshaft is fitted in the flywheel housing or in the backplate, inspect the seal lip for wear and for damage; renew the seal if necessary, see operation 14A-03. If there is only a small scratch across the lip, the seal must be renewed. Tool PD.550-1 can be used to press in the seal. The support ring of the tool is for use with aluminium backplates.
- 3 Ensure that the location dowels (B1) are fitted correctly. Ensure that the outside diameter of the crankshaft flange is clean. Put the seal protection sleeve (B2) in position on the crankshaft flange. Lubricate lightly, with clean engine lubricating oil, the outside diameter of the crankshaft flange and the protection sleeve.
- 4 Apply a 1,5 mm (0.06 in) continuous bead of POWERPART Sealant (Loctite 518) to the front face of the housing or backplate as shown in figure A. This operation is not necessary where a separate seal housing or a joint is fitted. Also apply sealant where the main bearing cap meets the cylinder block (see 14A.10A).
- 5 Fit the housing or the backplate onto the dowels and engage the setscrews.

If a backplate is used: Tighten the setscrews gradually and evenly to the relevant torques (given in section 11B) and in the relevant sequence, shown in figure 22A.05/A.

If a housing is used: Tighten the setscrews lightly.

- 6 Check the concentricity of the housing with a dial test indicator. The maximum permissible total indicator reading is 0,15 mm (0.006 in). If any adjustment is necessary, it must be made on the housing and the concentricity checked again.

- 7 Tighten the setscrews gradually and evenly to the relevant torques given in section 11B, in the relevant sequence shown in figure 22A.05/A.

- 8 Check the alignment of the rear face of the housing. The maximum permissible total indicator reading is 0,15 mm (0.006 in). All adjustments must be made on the housing and not on the cylinder block.

- 9 Marine engines: Fit the flywheel and the gearbox drive adaptor, operation 22A-01. Ensure that the dowels are correctly fitted in the backplate. Fit the adaptor housing for the gearbox, tighten the setscrews to 43 Nm (32 lbf ft) 4,4 kgf m). Check the housing concentricity (C) and the alignment (D) as in paragraphs 6 and 8 above. Fit the support plate for the manifold and, if necessary, connect the drain pipe to the turbocharger.

- 10 Fit the flywheel, operation 22A-01 and the starter motor, operation 23B-01. Fit the drive components to the rear of the engine.

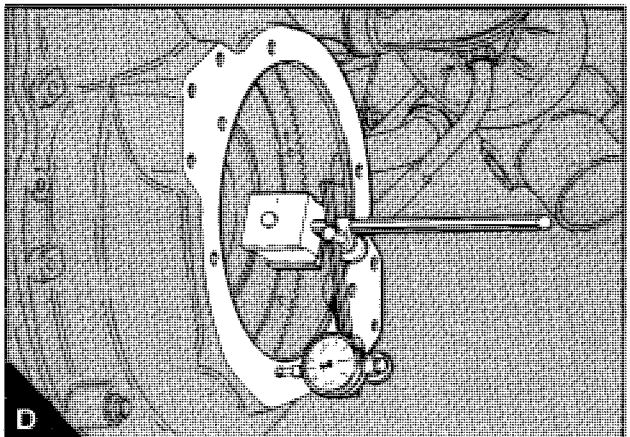
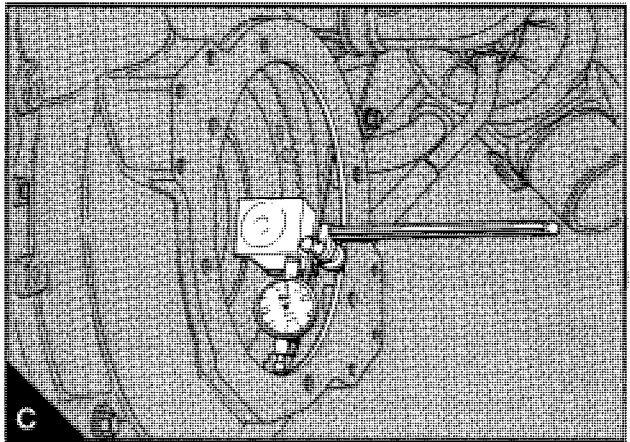
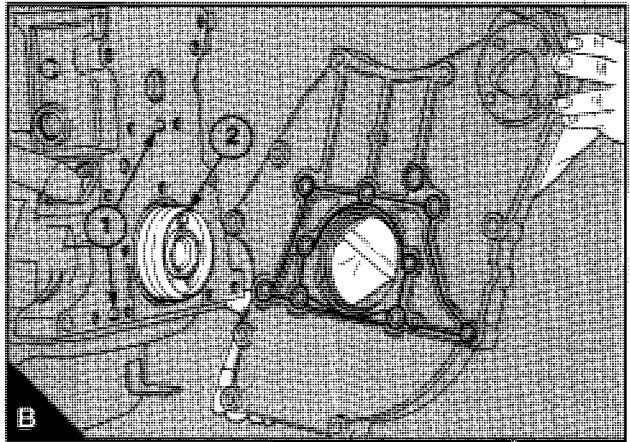
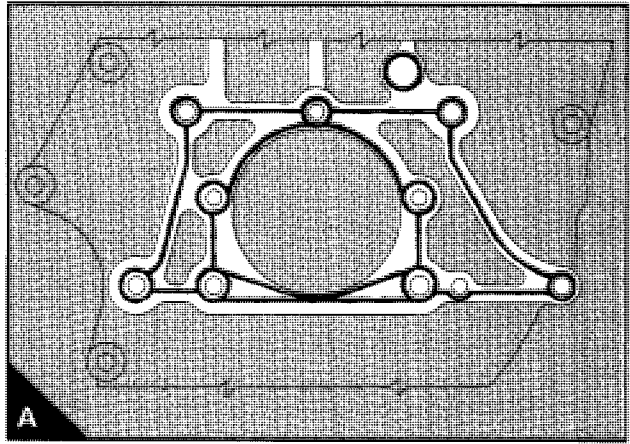

Reverse gearbox for marine engines

To remove and to fit

22A-04

- 1 Disconnect the propeller shaft and the selection control.
- 2 If a cooler is fitted to the gearbox, disconnect the cooler pipes.
- 3 Provide a support for the gearbox, release the nuts and remove the gearbox (B).
- 4 Ensure that the mounting faces of the gearbox and the adaptor housing are clean and are not damaged.
- 5 Align the gearbox shaft with the drive plate, fit the gearbox to the adaptor housing and tighten the nuts.
- 6 Connect the propeller shaft. If necessary, connect the coolant pipes to the gearbox cooler. Ensure that there is a gap of at least 30 mm (1 1/8 in) between the ends of the pipes and the ends of the cooler connections.

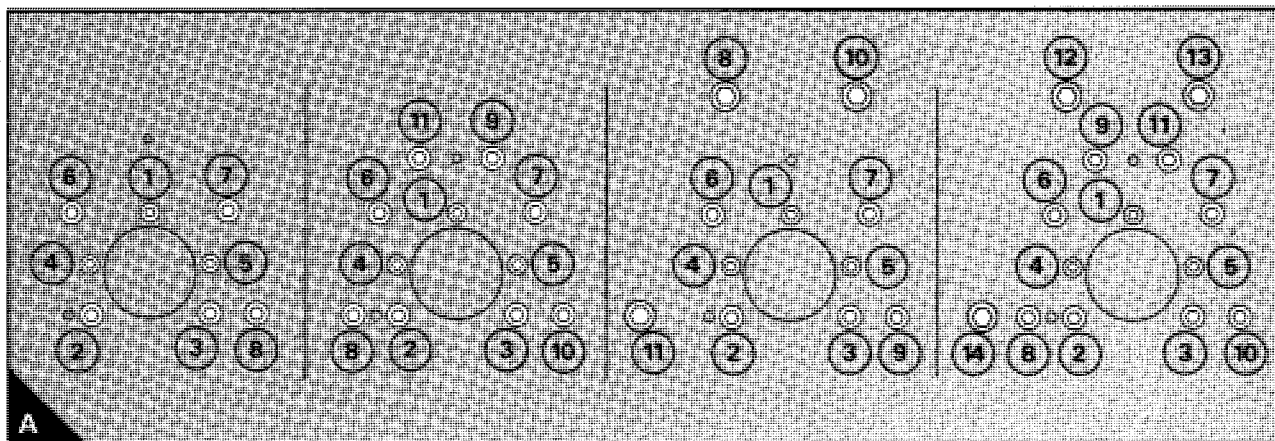
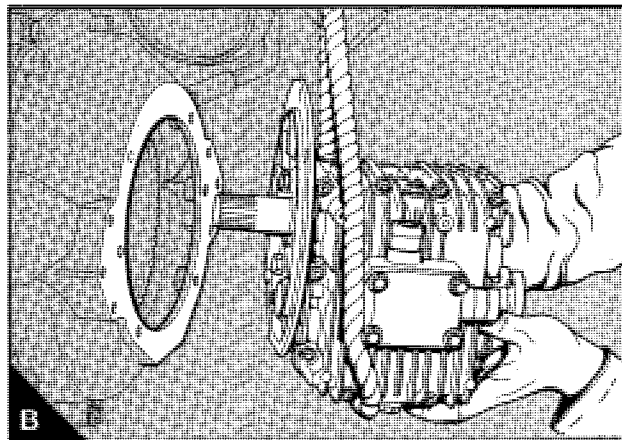





Electrical equipment

23

Alternators	23A
Starter motors	23B
Starting aid	23C
Wiring diagrams	23D



Alternators

23A

	General description	23A.02
	Precautions	23A.02
	Drive belt																		
23A-01	To check	23A.03
23A-02	To adjust tension	23A.03
23A-03	To remove and to fit	23A.03
	Alternator																		
23A-04	To remove and to fit	23A.04
	To maintain	23A.04
	Fault diagnosis	23A.04

General description

The Lucas A127 alternator is driven from the crankshaft pulley by a single drive belt. The rating of the alternator is 55A or 70A according to the application.

A solid state regulator is fitted in the rear of the alternator and includes the brush box as a part of the unit. The regulator is sealed and repair is not possible.

Precautions

To prevent damage to the diodes and to the resistors, the precautions given below must be followed.

- Do not disconnect the battery while the engine is in operation. This will cause a voltage surge in the alternator charge system which can cause damage to the diodes or to the transistors.
- Do not disconnect an electrical wire before the engine is stopped and all electrical switches are in the off position.
- Do not cause a short circuit by the connection of electrical wires to the wrong terminals. The correct identification of the electrical wire to the correct terminal must be made. A short circuit or wrong connection which gives reverse polarity can cause permanent damage to the diodes and to the transistors.
- Do not connect a battery into the system until it has been checked for correct polarity and voltage.
- Do not check for current flow with a spark contact as damage can be caused to the transistors.

Drive belt

To check **23A-01**

Special tool:
Tension gauge, J.23600-B

- 1 Check the belt for wear and damage and renew the belt, if necessary.
- 2 Check the belt tension. To ensure maximum belt life, it is recommended that a belt tensioner gauge is used. Fit the gauge (A) at the centre of the free belt length between the crankshaft pulley and the alternator pulley and check the tension. If a Burroughs gauge is used, the correct tension is 355 N (80 lbf) 36 kgf. If the tension is equal to or less than 267 N (60 lbf) 27 kgf, adjust it to 355 N (80 lbf) 36 kgf, operation 23A-02.

If no gauge is available, press down the belt with the thumb at the centre of the longest free length and check the deflection (B). With moderate thumb pressure, 45 N (10 lbf) 4,5 kgf, the correct belt deflection is 10 mm (3/8 in).

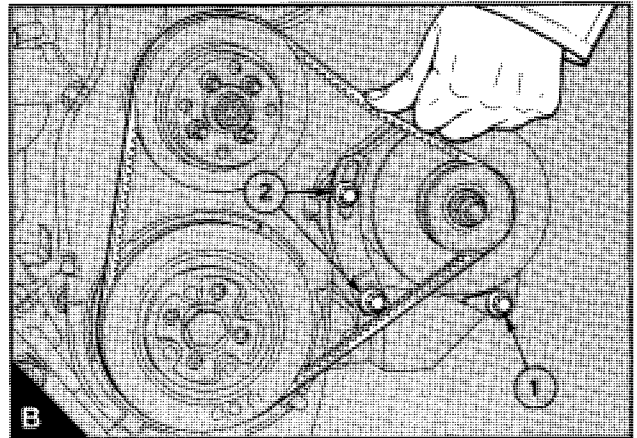
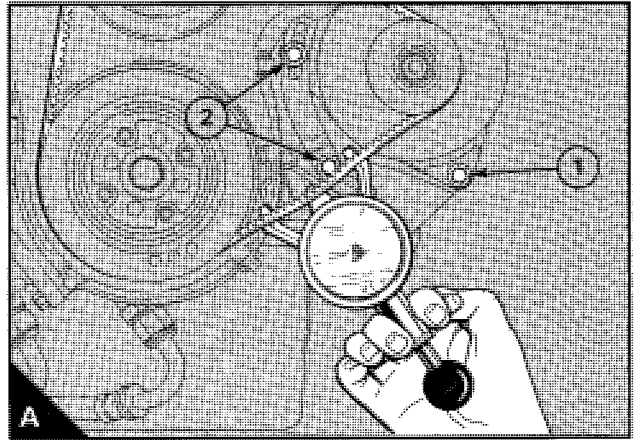

To adjust tension **23A-02**

- 1 Loosen the pivot fasteners of the alternator (A1 or B1) and the adjustment link fasteners (A2 or B2).
- 2 Change the position of the alternator to give the correct tension. Tighten the adjustment link fasteners and then the pivot fasteners of the alternator.
- 3 Check the belt tension again to ensure that it is still correct.

To remove and to fit **23A-03**

- 1 Loosen the pivot fasteners of the alternator and the adjustment link fasteners.
- 2 Release all of the tension from the belt and remove the belt.
- 3 Fit the belt and adjust the tension as indicated in operation 23A-02. If the belt is new, set the initial tension to 440 N (100 lbf) 45 kgf or to a 6 mm (1/4 in) deflection. The tension of a new belt must be checked again after the first 1000 km (500 miles) or 20 hours of operation. At this time, the tension should be at least 355 N (80 lbf) 36 kgf or the deflection should be 10 mm (3/8 in) maximum.

Alternator

To remove and to fit

23A-04

To remove

- 1 Disconnect the electrical connections at the alternator.
- 2 Loosen the pivot fasteners of the alternator and the adjustment link fasteners.
- 3 Release all the belt tension and remove the belt.
- 4 Remove the adjustment link from the alternator and remove the pivot bolt. Make a note of the position of the washer to ensure that it is fitted correctly. Remove the alternator (A).

To fit

- 1 Put the alternator in position and assemble loosely the pivot fasteners and the adjustment link and its fasteners. Ensure that the washer is fitted in its correct position and that the alternator pulley is aligned to the crankshaft pulley.
- 2 Fit the drive belt and adjust the drive belt tension, operation 23A-02. Tighten the adjustment link fasteners and then the pivot fasteners and check the tension again.
- 3 Connect the electrical connections at the alternator.

To maintain

- 1 Ensure that the drive belt is not worn and that the belt tension is correct.
- 2 Keep the alternator clean. To clean the alternator, use a material which is damp with kerosene or a special fluid used for this purpose. Ensure that the fluid does not enter the alternator.
- 3 Ensure that air can pass easily over the casing to keep it cool.

Fault diagnosis

The alternator is designed so that a flow of current (indicated by no light at the warning light or by a reading shown on an ammeter) shows that the system is in correct operation. If the system is in correct operation, no open circuit, voltage or current output checks need to be done on the installation unless:

- The warning light does not show when the alternator is stationary and the switch is in the "on" position or it shows a light when the alternator is in operation.
- No charge current is shown on the ammeter.
- The battery is discharged.
- The battery is hotter than normal which is an indication of loss of voltage control.

If one or more of the above symptoms occur, the procedure indicated below should be applied.

- 1 Ensure that the battery is in a fully charged condition.
- 2 Connect a moving-coil voltmeter of good quality, with a range of 0-50 volts, across the alternator positive and negative terminals.

If an ammeter is not fitted in the electrical circuit: Fit a moving-coil ammeter of good quality, with a range of 0-100 ampere, in the wire between the alternator and the positive terminal of the battery.

- 3 Turn the warning light switch to the "on" position (main switch on instrument panel) when the warning light should be illuminated.
- 4 Switch on a 10-15 ampere load, for example, lights, fans, etc..

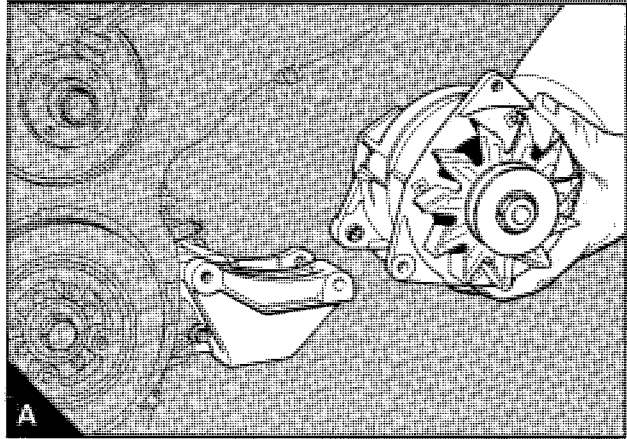

- 5 Start the engine and operate it at a fast idle speed when either: the warning light should be extinguished or the ammeter indicates a small current charge in relationship to the engine speed.

- 6 Increase the engine speed for a moment to near maximum speed; the charge current should be approximately 55 amperes for A127-55 alternators or 70 amperes for A127-70MT alternators.

- 7 Operate the engine at approximately half speed and remove the electrical load. The voltage should go up to 14 volts for a 12 volt system and then remain constant. At the same time the current reading should show a reduction.

Any change in the above data can indicate a fault and the alternator should be removed for test by a specialist.

The regulator is a sealed unit and a repair is not possible. If there is a regulator fault, the regulator must be renewed.

General description

- I The starter motor is a pre-engaged type. The internal drive of the
- I M80R starter motor is through an epicyclic gearbox.

A roller clutch prevents armature rotation at high speed if the starter is held in the engaged position.

These starters have needle roller bearings to allow higher loads to be applied.

Starter motor

To remove and to fit

23B-01

To remove

- 1 Disconnect the battery.
- 2 Disconnect the starter motor cables.
- I 3 Release the fasteners and remove the starter motor (A).

To fit

- 1 Fit the starter motor and tighten the fasteners.
- 2 Connect the starter motor cables.
- 3 Connect the battery.

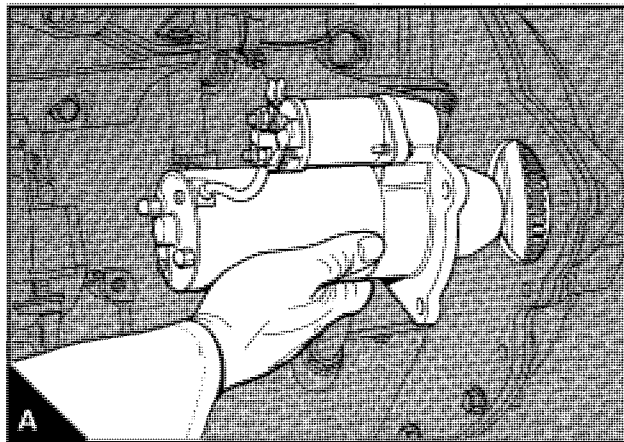

- I For M80R starter motors, the brush assembly and the armature assembly can be fitted into the body together but they will be pulled into position by the effect of the magnets. Ensure that the thrust washer remains in position on the front of the armature shaft.

- I When the brush plate assembly is to be fitted on 2M113 starter
- I motors, ensure that the slots in the brake segments align with the
- I pin in the drive shaft.

If a repair is necessary to the switch gear, etc. the starter must be sent to a specialist for repair.

To maintain the brush gear and the commutator

23B-02

The starter motor must be removed from the engine. The brush assembly can be removed from the armature assembly I after the rear plate or the rear cover has been removed.

Inspect the brushes to ensure that they are free in their guides and that the wire connections are free to move. To check this, remove the spring retainer and the spring from each brush and pull carefully on the flexible connection. If the brush does not move freely, remove it from its holder and clean the sides with a material which is damp with gasoline.

- I Ensure that the brushes are fitted in their original positions to keep the original wear seat. The brushes must have good seats which conform to the shape of the commutator. If the length of the
- I brushes has been reduced to the service limit (see Section 11C), the brushes must be renewed.

The new brushes must be the exact same grade as the original brushes. To ensure that correct brushes are fitted, use only parts from the approved manufacturer.

- I To remove the earth brushes from M80R starter motors, release the clips and withdraw the brushes. To remove the field brushes, remove the insulation plate and remove the bus bar and brush assembly.

- I In 2M113 starter motors, the wires for the brushes are soldered to
- I their connections. Before the brushes are inserted in their holders, it is advised that the holders are cleaned with compressed air or with a material which is damp with gasoline.

The commutator must be completely clean of dirt and oil. Any sign of dirt or oil must be removed with a piece of clean dry material (with no loose fibres). If the commutator is dirty (or has a colour other than its natural colour) it may be possible to clean it with a fine carborundum paper or similar material. If this is not possible, send the starter to a specialist for repair.

To test on the engine

23B-03

Ensure that the battery is in a fully charged condition.

Turn on lights and operate the starter switch. If no lights are fitted to the machine, connect a voltmeter across the battery terminals and operate the starter switch.

If the starter does not operate but the lights keep their power (or there is no voltage drop across the battery) check the switch and all the connections and wires. Slow action of the starter can be caused by faulty connections.

Starting aid

23C

	General description	23C.02
	Glow plugs																		
23C-01	To remove and to fit	23C.02
	To check power supply and continuity	23C.02
	To check operation of glow plugs	23C.02

General description

The starting aid for these engines consists of a set of glow plugs, one for each cylinder.

The glow plugs are fitted in the cylinder head near to the atomisers. The tip of the plug reaches into the combustion cavity of the piston when the piston is at TDC.

The plugs are operated electrically, usually through the start switch. When the plugs are energised, their tips become very hot and improve the combustion process during cold start conditions.

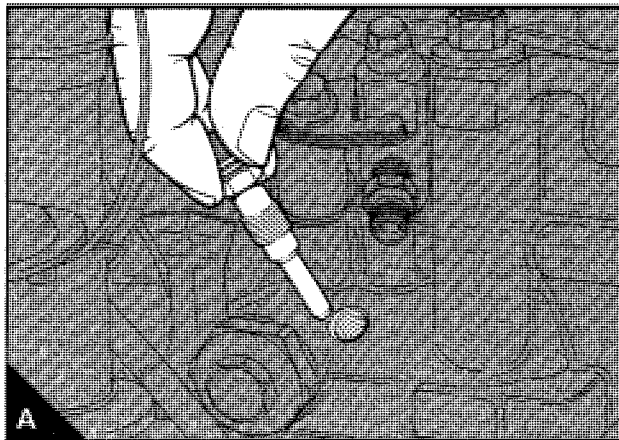

Glow plugs

To remove and to fit

23C-01

- 1 Disconnect the electrical connections at the glow plugs.
- 2 Release and remove the glow plugs (A).
- 3 Ensure that the threads and the contact faces of the plugs and the cylinder head are clean. Apply an anti-seize compound, which is suitable for high temperatures, to the threads and the tapered seats of the plugs. Fit the plugs and tighten them to 20 Nm (15 lbf ft) 2,0 kgf m.
- 4 Connect the electrical connection to the plugs.

To check power supply and continuity

- 1 Connect a 12 V test lamp between the positive terminal of the battery and earth to check that the lamp will show a light.
- 2 Connect the test lamp between the terminal of the glow plug which is furthest away from the power supply and earth. Operate the control switch and the test lamp should show a light if the power supply is correct.
- 3 Disconnect the cables at the glow plug terminals.
- 4 Connect the test lamp to the positive terminal of the battery and to the terminal of each glow plug. The lamp will show a light if the continuity is correct. If there is no light when a glow plug is checked, renew the plug.
- 5 When all the glow plugs have been checked, connect the cables to the plug terminals.

To check operation of glow plugs

- 1 Disconnect the power supply cable and the connection cables from the terminals of the glow plugs.
- 2 Connect a 50-0-50 ammeter between the power supply cable and the terminal of a glow plug. Connect a 0-20 voltmeter between the plug terminal and earth.
- 3 Engage the control switch and check the readings of the ammeter and the voltmeter.

With a 12 volt supply, there should be an initial current of approximately 27 amperes which should be reduced to approximately 14 amperes after approximately 10 seconds. The voltmeter reading after this time should be approximately 11 to 12 volts.

If the ammeter reading is low or there is no reading, renew the glow plug. If there is no voltmeter reading, check the switch and the power cable.

- 4 When all the glow plugs have been checked, remove the ammeter and the voltmeter and connect the supply cable.

Wiring diagrams

23D





















Wiring diagrams for marine engines 23D.02











Wiring diagrams for marine engines

These wiring diagrams apply only to wiring looms and instrument panels which have been supplied by Perkins.









Notes for wiring diagrams of instrument panel (23D.03/A) and engine (23D.03/B)

I * Not used on later engines

-  Starter motor 12 V
-  Alternator
-  Glow plugs
-  Glow plug relay (33RA)
-  Negative earth relay (33RA)
-  Three/two 1 amp diodes '1', '2** & '3'
-  Start relay (33RA)
-  Coolant temperature switch for start advance solenoid (open on increase in temperature)*
-  Start advance solenoid (KSB)*
-  Engine stop solenoid (energise to stop)
-  Oil pressure switch
-  Coolant temperature switch
-  Coolant temperature sender
-  Six way connector - to be sealed with tape to prevent entry of water
-  Eight way connector - to be sealed with tape to prevent entry of water
-  Two fast fuses
-  Water warning device option (includes warning lamp 12V/1.2W bulb)
-  Connector - optional illumination switch (customer supply)
-  Spare cables
-  Fit insulation to all spare cables and fasten to wiring loom with tape

-  Battery (customer supply)
-  Connect earth cable to starter motor fastener
-   indicates engine earth
-  Security key switch
-  Heat switch (push button)
-  Start switch (illuminated push button - 24V/1.2W bulb)
-  Stop switch (illuminated push button - 24V/1.2W bulb)
-  Warning lamp for coolant temperature - 12V/1.2W bulb
-  Four/two amp diodes '4', '5', '6** and '7**

Code	Colour	Code	Colour	Code	Colour
N	Brown	G	Green	W	White
B	Black	P	Purple	U	Blue
Y	Yellow	R	Red	LG	Light Green

-   Warning lamp for oil pressure - 12V/1.2W bulb
-  Warning lamp for alternator - 12V/2W bulb
-  Tachometer - illuminated - 12V/2W bulb
-  Temperature gauge - illuminated - 12V/2W bulb
-  Audible alarm
-  Diode panel
-  Connectors 'D', 'W', 'X', 'Y' and 'Z'

I  For earlier Prima M80T only*
WARNING - On all other engine models cables **must** be fitted with insulation and fastened to wiring loom with tape

 **39**

Resistance of battery cables 1 and 2 not to be more than 0.0017 ohms								
Maximum total length		Cable size	Nominal cross section area		Nominal resistance in ohms		Approx. equivalent sizes	
m	ft	Metric	mm ²	in ²	per m	per ft	English Imperial	American B & S SAE
2,2	7.3	37/0,9	23,54	0,0365	0,000762	0,0002323	37/036	3
3,7	12,0	61/0,9	38,80	0,0601	0,000462	0,0001408	61/036	1
5,6	19,0	61/1,3	61,175	0,0948	0,000293	0,0000890	61/044	00
9,0	28,3	19/2,52	95,00	0,1470	0,000189	0,0000600	513/018	000

It is recommended that an isolation switch is fitted in the positive battery cable

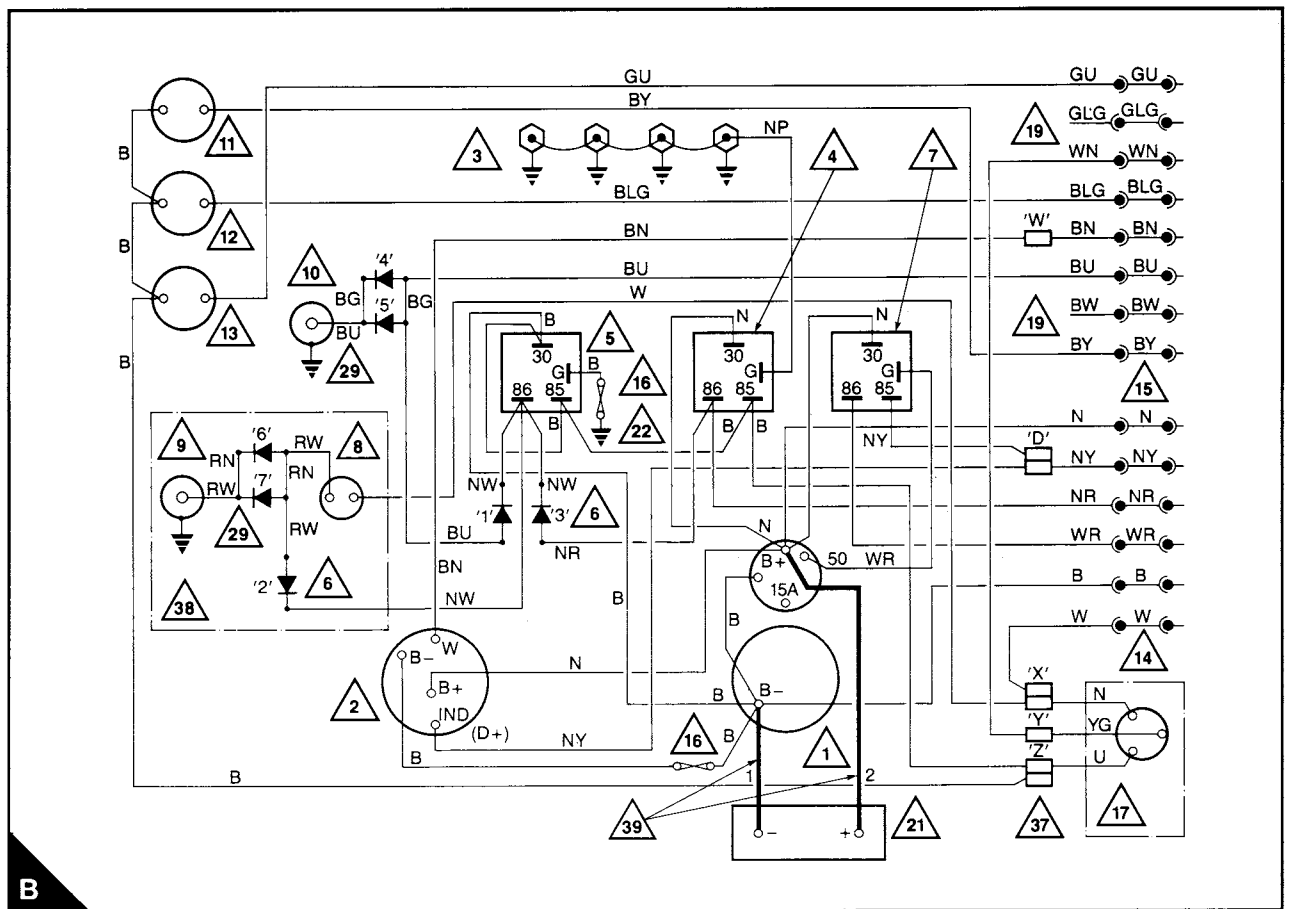
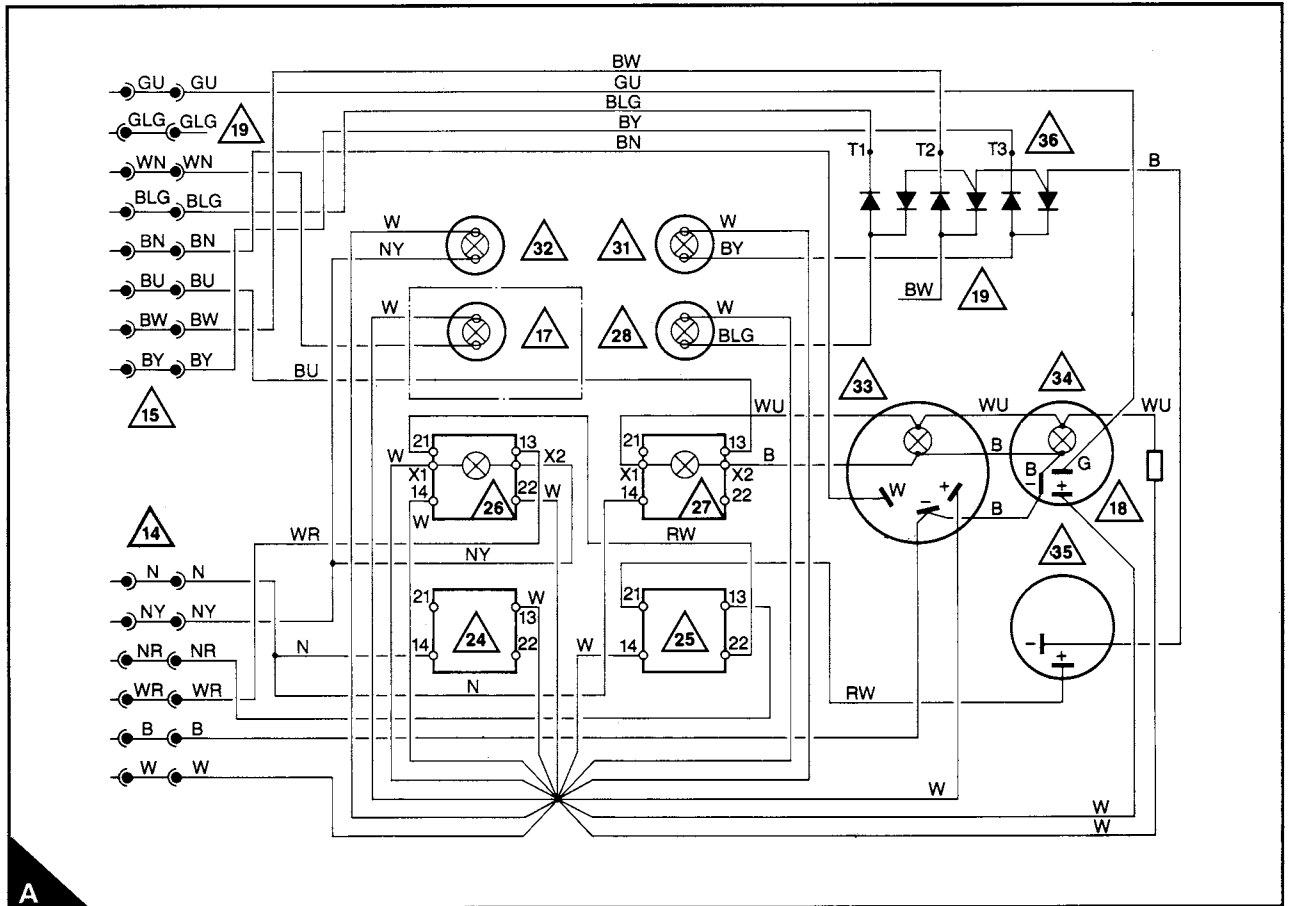



Auxiliary equipment

24

	General description	24A.02
	Exhauster																			
24A-01	To remove and to fit	24A.02
	To test	24A.02

General description

The plunger type exhauster is fitted to the camshaft cover and the cylinder head and is driven by an eccentric on the engine camshaft. The exhauster cannot be dismantled and, if it has a fault, it must be renewed.

Exhauster

To remove and to fit

24C-01

To remove

- 1 Remove the setscrew from the timing hole in the top front of the camshaft cover. Turn the crankshaft until the timing hole in the front journal of the camshaft aligns with the hole in the camshaft cover. This will make it easier to remove and to fit the exhauster.
- 2 Disconnect the pipes from the exhauster.
- 3 Release evenly and gradually the nuts and the setscrews and remove the exhauster (A).

To fit

- 1 Ensure that the joint faces of the exhauster, the camshaft cover and the cylinder head are clean and are not damaged. Renew the sealing ring (A1).
- 2 Ensure that the timing hole in the front journal of the camshaft aligns with the timing hole in the top front of the camshaft cover. Fit the exhauster to the camshaft cover and the cylinder head and engage the setscrews and the nuts and bolts. Gradually and evenly tighten the fasteners.
- 3 Connect the pipes to the exhauster.
- 4 Fit the setscrew to the timing hole in the top front of the camshaft cover.

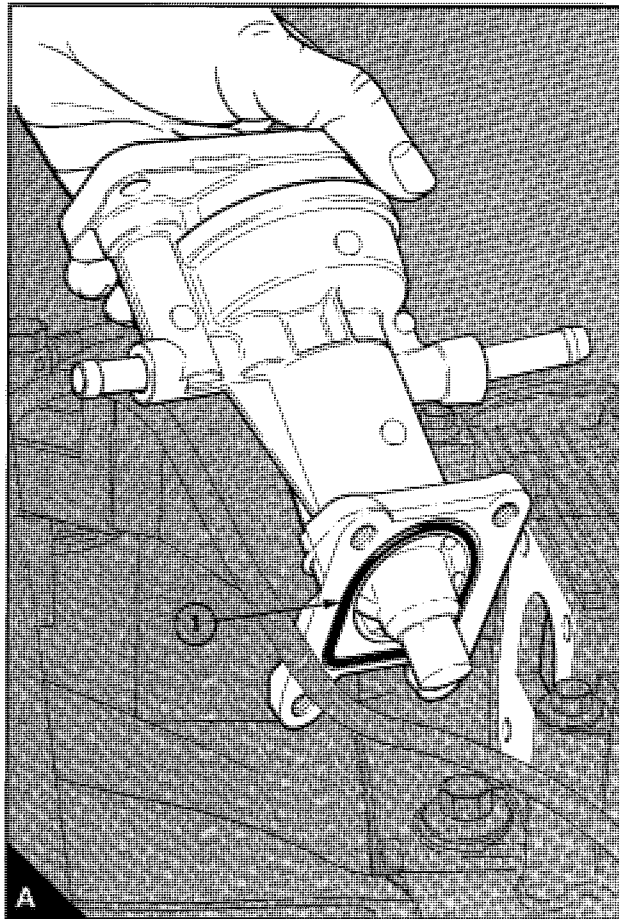

To test

1 If a brake assistance reservoir of two litres capacity is used: Connect a vacuum gauge between the exhauster and the vacuum pipe. Run the engine at 950 rev/min and check that the time taken to reach a vacuum of 70 kPa (525 mm Hg) 21 in Hg is not greater than 12.5 seconds.

If the capacity of the reservoir is not known: Disconnect the vacuum pipe at the pump and fit a vacuum gauge to the pump connection. Run the engine at 950 rev/min and check that a vacuum of at least 75 kPa (562 mm Hg) 22 in Hg is obtained.

- 2 Renew the exhauster, if necessary.
- 3 If the readings are correct, remove the vacuum gauge and connect the vacuum pipe to the exhauster.

List of special tools

25

List of special tools 25A.02



List of special tools

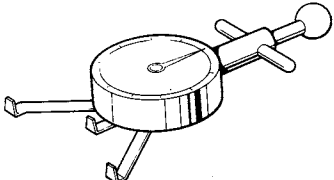
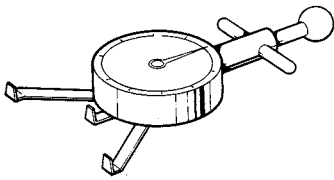
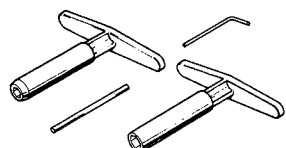
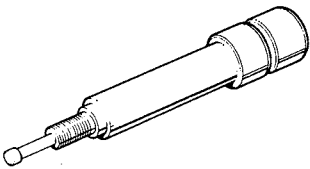
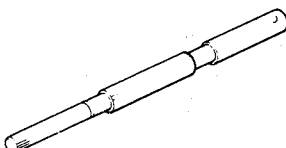
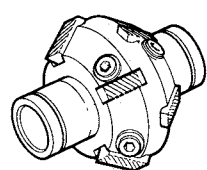
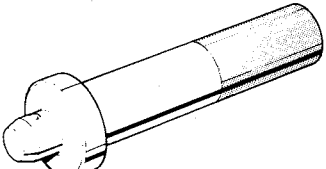

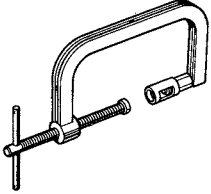
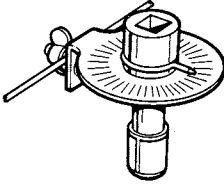
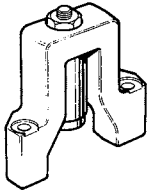
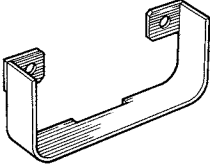
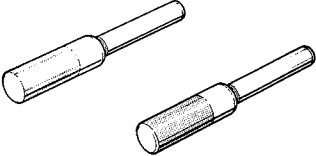
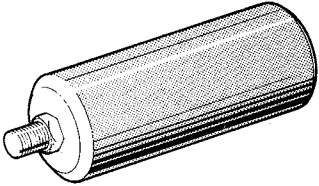
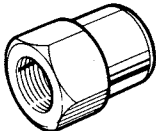
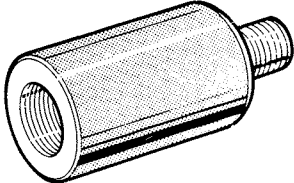
These tools are available from V.L. Churchill Limited, P.O. Box 3, London Road, Daventry, Northamptonshire, England, NN11 4NF.

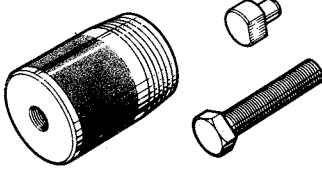
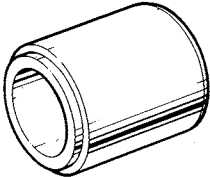
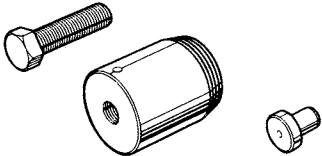
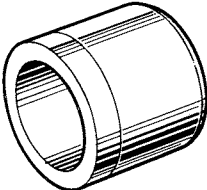
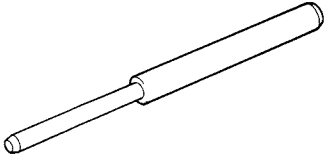
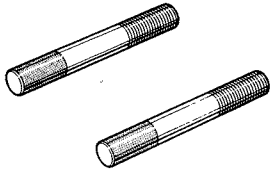
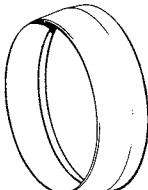
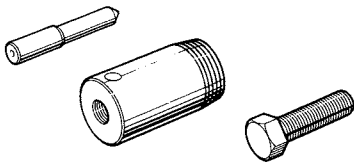
Number	Description	Illustration
J.23600-B	Tension gauge for drive belt for alternator.	
KM.4088P	Tension gauge for timing belt.	
MS.76B	Handle set for valve seat cutters.	
MS.107	Adaptor to check plunger lift of fuel injection pump; use with PD.208.	
MS.150-7	Adjustable pilot for valve seat cutters.	
MS.275	Cutter for valve seats (also included in MS.73A).	
MS.550	Universal drive handle.	

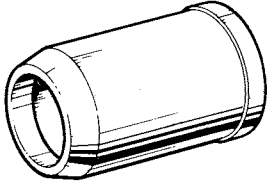
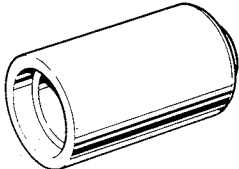
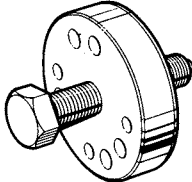
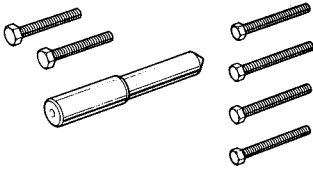
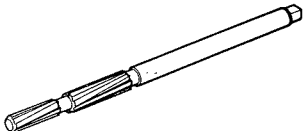
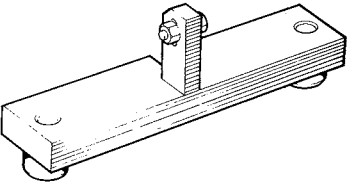
Number	Description	Illustration
MS.1519A	Valve spring compressor.	
MS.1531	Angle gauge to tighten cylinder head setscrews.	
PD.180	Camshaft clamps (set of three).	
PD.181	Camshaft retainer.	
PD.182	Timing pins for camshaft and crankshaft.	
PD.184	Slide hammer for atomiser removal (main tool).	
PD.184-1	Adaptor for Bosch atomisers; use with PD.184.	
PD.184-2	Adaptor for CAV atomisers; use with PD.184.	

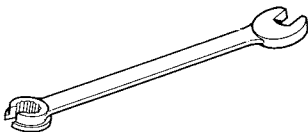
Number	Description	Illustration
PD.185	Remover for front oil seal of camshaft.	
PD.186	Replacer for front oil seal of camshaft.	
PD.187	Remover for rear oil seal of camshaft.	
PD.188	Replacer for rear oil seal of camshaft.	
PD.189	Remover/replacer for valve guides.	
PD.190	Location pins for fuel pump pulley.	
PD.191	Protection sleeve for rear oil seal of crankshaft.	
PD.192	Remover for front oil seal of crankshaft.	

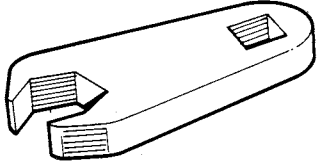
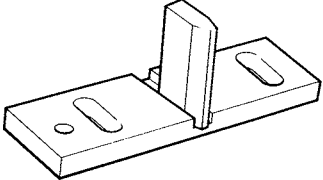
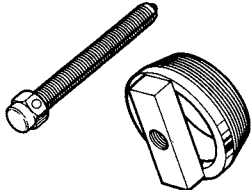
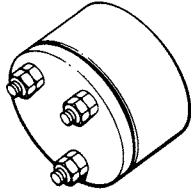
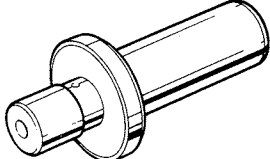
Number	Description	Illustration
PD.193	Protection sleeve for front oil seal of crankshaft.	
PD.194	Replacer for front oil seal of crankshaft.	
PD.195	Remover for toothed pulleys of fuel injection pump and crankshaft (main tool).	
PD.195-1	Adaptors for use with PD.195.	
PD.196	Reamer for new valve guides.	
PD.197	Gauge for piston height and valve depth.	
PD.197-1	Plate for piston height check; use with PD.197.	
PD.201	Spanner for oil pipe connection at turbocharger.	

Number	Description	Illustration
PD.202	Remover/replacer wrench for stop solenoid of fuel injection pump.	
PD.203	Anti-rotation tool.	
PD.204	Remover for rear oil seal of crankshaft.	
PD.205	Replacer for rear oil seal of crankshaft.	
PD.207	Alignment adaptor for mounting of raw water pump.	
PD.208	Dial gauge for use with PD.197 and MS.107.	
PD.550-1	Replacer for rear oil seal of crankshaft with housing off engine; use with MS.550.	