

4-5 Alternator functioning

(1) IC regulator

The IC regulator is the transistor (Tr_1) which is series-connected with the rotor. The IC regulator controls the output voltage of the generator by breaking or conducting the rotor coil (exciting) current.

When the output voltage of the generator is within the standard value, the transistor (Tr_1) turns on. When the voltage exceeds the standard value, the Zener diode goes on and the transistor (Tr_1) turns off.

With the repeated turning on and off of the transistor, the output voltage is kept at the standard value. (Refer to the circuit diagram below.)

(2) Charge lamp

When the transistor (Tr_1) is on, the charge lamp key switch is turned to ON, and current flows to R_1 , R_4 and to Tr_1 to light the lamp. When the engine starts to run and output voltage is generated in the stator coil, the current stops flowing to this circuit, turning off the charge lamp.

(3) Circuit diagram

4-6 Handling precautions

(1) Be careful of the battery's polarity (+, - terminals), and do not connect the wrong terminals to the wrong cables, or the battery will be short-circuited by the generator diode.

In this case too much current will flow, the IC regulator and diodes burn out, and the wire harness will burn.

(2) Make sure of the correct connection of each terminal.

(3) When quick-charging, etc., disconnect either the battery terminal on the AC generator or the terminal on the battery.

(4) Do not short-circuit the terminals.

(5) Do not conduct any tests using high tension insulation resistance. (The diodes and IC regulator will burn out.)

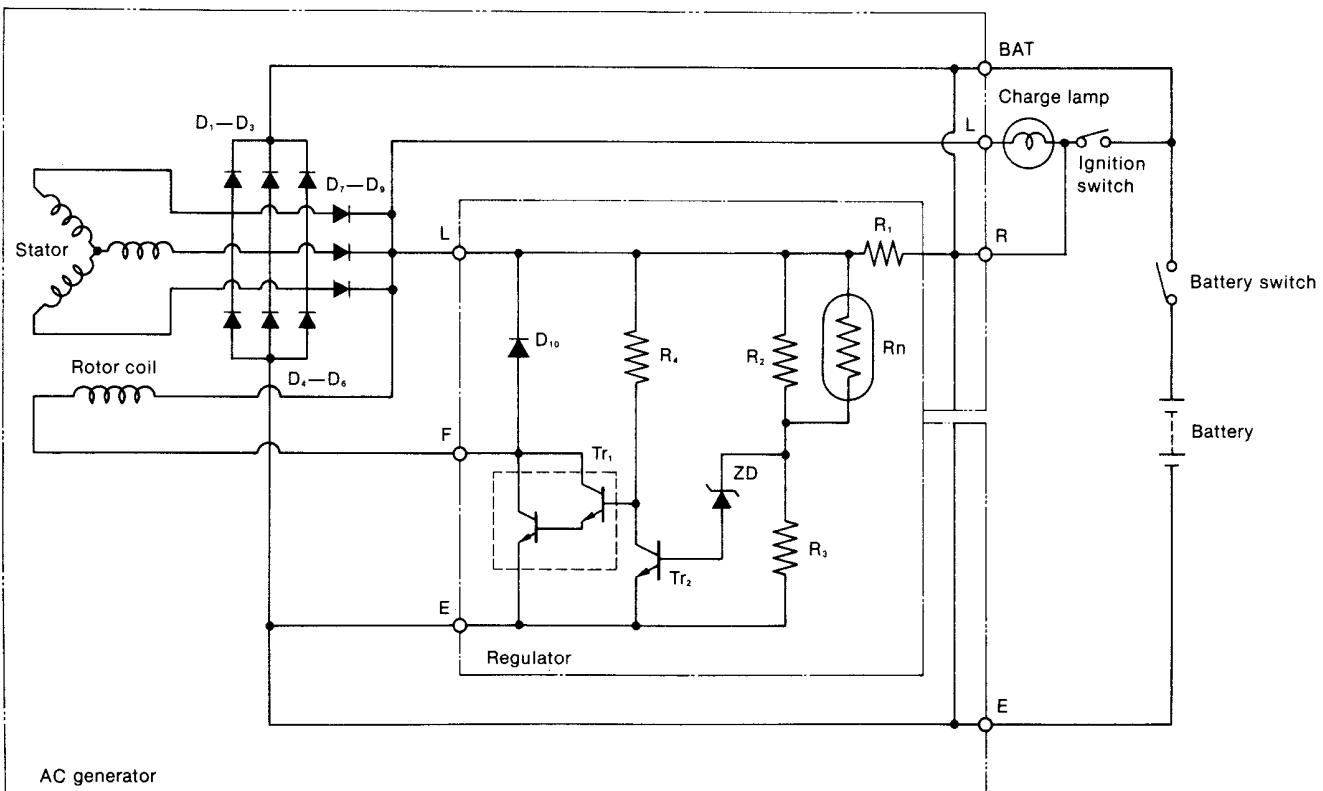

- | | | | |
|----------------|---------------------------|-------------|--|
| BAT: | Generator output terminal | D_1-D_6 : | Output commutation diode |
| D_{10} : | IC protecting diode | R_1-R_4 : | Resistor |
| L: | Charge lamp terminal | D_7-D_8 : | Charging lamp switching diode |
| ZD: | Zener diode | F: | To supply current to rotor coil |
| E: | Earth | R_n : | Thermistor (Temperature gradient resistance) |
| Tr_1, Tr_2 : | Transistor | | |