

## Endurance LiFePO<sub>4</sub> battery testing

S. Papezova<sup>1,\*</sup> and V. Papez<sup>2</sup>

<sup>1</sup>Czech University of Life Sciences in Prague, Faculty of Engineering, Department of Electrical Engineering and Automation, Kamycka 129, CZ165 21, Prague 6 - Suchdol, Czech Republic

<sup>2</sup>Czech Technical University in Prague, Faculty of Electrical Engineering, Department of Electrotechnology, Technicka 2, CZ166 27 Pague 6, Czech Republic

\*Correspondence: papezovas@etf.czu.cz

**Abstract.** A lithium-iron-phosphate (LiFePO<sub>4</sub>) battery is nowadays considered one of the best types of batteries. Manufacturers and mostly suppliers indicate that LiFePO<sub>4</sub> batteries have much longer lifespan than other batteries, and thus convincing their customers of lower operating costs than at other types of batteries, although their purchase price is several times higher. In connection with the problem of replace Pb batteries in the backup sources of security systems with LiFePO<sub>4</sub> batteries, there has been necessary to determine the real parameters of available cells under conditions in which they operate. The paper describes the battery tests, in which their real parameters, comparable with the parameters indicated by the suppliers, are tested. The tests lie in automatic long-term cyclical charging and discharging of the multi-cell battery. Operating parameters are continuously monitored, recorded and evaluated by the computer. Individual cells are equipped with balancers and protection circuits that prevent from exceeding the maximum voltage during charging, as well as the voltage drop below a minimum level during discharging. The results of long-term tests on LiFePO<sub>4</sub> WB-LYP40AHA Winston Battery are presented. The first test was conducted with 100% depth of discharge (DOD). New cells, after the first charge and discharge, showed the capacity about 115% of the rated capacity, the capacity drop c. 0.015 to 0.02% per cycle and the capacity drop to 80% after 950 cycles, which represents a lifetime of about 5% less than state the manufacturers.

A second test was conducted with 50% depth of discharge. Here, again after the first charge and discharge, new cells exhibited the same capacity as in the first case, i.e. c. 113% of the rated capacity. After 1,000 cycles, the cell capacity decreased to 107% of the rated capacity, which corresponds to the expected lifetime of 5,000 cycles.

**Key words:** LiFePO<sub>4</sub> battery, lifespan, capacity drop, depth of discharge.

### INTRODUCTION

One of the barriers for usage of all types of accumulators is their lifespan. Their producers and retailers are providing to their potential end users information about their products. But there are especially accentuated their beneficial properties – the possibility of charging and discharging by high currents, minimum influence of the discharge time on capacity, long durability. Measuring of lifespan according to producers specifications is done in cycles, discharging the cells to defined DOD and then charging it to a maximal

allowed value, then after many cycles, deterioration of the parameters is observed, as well (Cenek et al., 2003; Lust, 2010).

The lifetime at standard LiFePO<sub>4</sub> batteries is usually indicated in the range of 1,000–7,000 cycles, DOD 70–100% and usually stated capacity drop of 80% of the nominal value, as shown in Fig. 1. It is valid for LYP, LFP and CA batteries from different manufacturers (Scrosati et al., 2013; Liberty, 2017; Sinopoly, 2017; Thunder-Sky, 2017; Winston-Battery, 2017a).

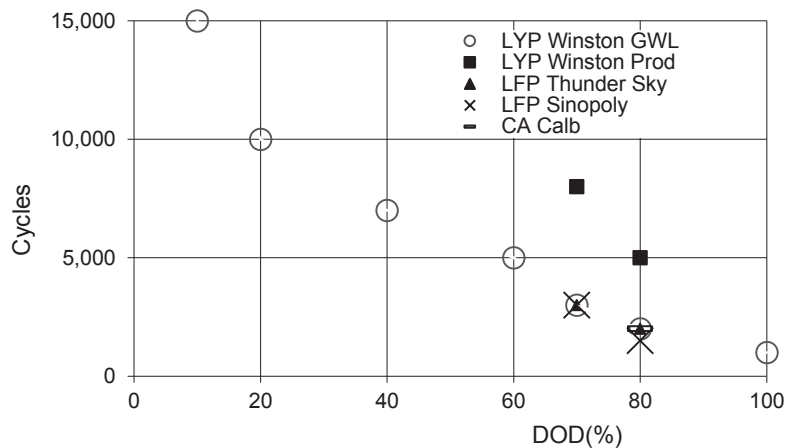

**Figure 1.** LiFePO<sub>4</sub> battery lifetime according to different sources.

Indicated values sometimes differ by more than 100%, even at the same products from the same manufacturer. The data published by the manufacturer or the distributor often differs.

The most important criterion for determining real quality of the supplied batteries is to verify a real lifetime of LiFePO<sub>4</sub> batteries.

Testing of the LiFePO<sub>4</sub> accumulators is practiced on the special testing station where charging and discharging is automated (Papez & Papezova, 2016).

## MATERIALS AND METHODS

The evaluation of operational parameters of specific LiFePO<sub>4</sub> cells during the long-term measurement is performed by a special testing system. Charging and discharging processes are controlled by a computer and are fully automated. Operating parameters of the tested accumulator are continuously scanned, recorded and evaluated by the personal computer (Srovnal, 2002; Kreidl & Svarc, 2006).

Individual cells are equipped with balancing and protection circuits that prevent the cell from exceeding the maximum voltage during charging and also from voltage drops below the minimum level during discharging. The testing system consists of a DC power supply, electronic load, switch control unit, cell balancers, input-output card and a computer see Fig. 2.

The source of electricity is the laboratory MANSION HCS source 3402 with maximum output voltage of 32 V and current of 20 A. The charging current and voltage can be set manually or from the computer.

STATRON 3227 with 200 W power output is used as an electrical load, it has maximum voltage of 80 V and current of 25 A. Discharging current can be set manually, its stability reaches 1% from the set value for 4 cells of LiFePO<sub>4</sub> accumulators. The load also has an automatic protection of the accumulator against unintended discharging after turning off and when the terminal voltage drop below the set value. This controlling algorithm was not used because of its low reliability.

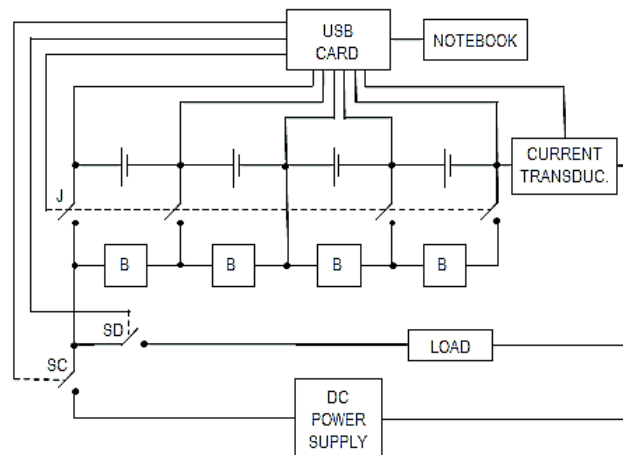

**Figure 2.** Block diagram of a testing workplace; B – balancer, SC – charging relay, SD – discharging relay, J – breaker.

The relay switches control the high power circuits. These relay switches have high reliability and robust construction. Bistable relays J which are used in this system do not need constant control current. Relays are controlled by logical signals from the interface card, which are connected to the transistor switches through opto-couplers.

The charging of not quite identical cells connected in series is controlled by the network of balancers. Each cell is connected in parallel to the electronic circuit. If a cell terminal voltage reaches the desired value during charging, the circuit consumes charging current supplied from the cell and stabilizes the terminal voltage at a desired value. Other cells connected in series are still charged by a charge current to the maximum voltage and full charge.

The balancer is designed as an electronic load controlled by a circuit of three-terminal adjustable shunt regulator, whose output amplifier is extended by another external amplifier which allows loading the balancer with the current of 10–16 A. The external amplifier stage further reduces the dynamic resistance of the shunt regulator by 2–3 orders. The balancer has a very low dynamic resistance (c. 1 mΩ), as shown in Fig. 3. In the situation, when the internal frequency compensation at the amplifier shunt regulator cannot be changed, two external damping Boucherot RC circuits are applied to reach system stability. The achieved characteristic of complex admittance satisfies the condition of absolute stability. The balancer can be loaded by the current of up to 20 A.

The problem of cooling the power transistor, which is loaded with the power dissipation of 80 W, must also be strongly solved.

When using the charging current of 10 A, the balancer safely reduces the maximum voltage to 4V at the charged cell. Through discharging time, during the inactivity, the balancer consumes less than 1 mA, which causes negligible discharging of the cell.

The relay switches control the high power circuits. These relay switches have high reliability and robust construction. Bistable relays J which are used in this system do not need constant control current. Relays are controlled by logical signals from the interface card, which are connected to the transistor switches through opto-couplers.

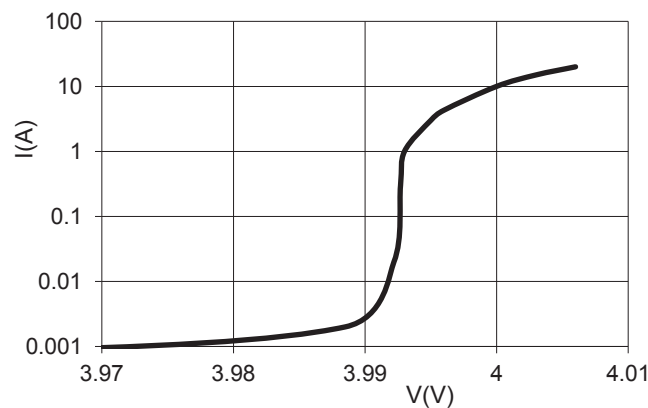

**Figure 3.** Balancer I–V characteristic.

The charging and discharging networks of accumulators are operated by SC and SD switches. During the accumulator charging, the charging source is connected by an SC switch. The accumulator discharge occurs by switching off the SC switch and subsequent switching on the SD. The accumulator discharge occurs by disconnecting the SC switch and subsequent contacting the SD switch.

Scanning the analogue electrical signals from the accumulators and generating control signals for controlling the function of switches, which set the desired mode and ensure continuous emergency protection of the operating modes, is provided by a measuring card USB 6211. An input card with 16-bit converters enables achieving an absolute error in determining cell voltage of 0.3 mV at a chosen input range of the  $\pm 10$  V analogue inputs. Switches SC and SD are controlled by the logic signals of the card.

The temperature of the accumulator cells was continuously monitored by a thermal imager, because we were initially afraid of possible overheating, or, in the worst case, of possible inflammation of the cells. But under the applied current, nothing like happened during the operation. The temperature of the cells was practical equal to the ambient temperature of 20 °C.

The testing workplace control is provided by the program in a system-design platform LabVIEW implemented in the PC.

In the first part of the program, it is necessary to set the technical parameters of the cells for testing. These parameters are given by producers and their limits must not be exceeded. For accumulator protection there are limit values of voltage. After reaching

this limit value, the program will generate signal for disconnecting the bistable relays. Accumulators are then disconnected from the DC power supply and from the load. The testing is ended so the damage of the accumulator is prevented. In program, these parameters can be set: maximum voltage on the cell, when the bistable relays is set on  $U_{\max\_L}$ , minimal voltage on the cell, when the bistable relays is set on  $U_{\min\_L}$ , terminate charging voltage of the cell, when the system will be switched to the discharging  $U_{\max\_C}$  and the terminate discharging voltage of the cell when the system will be switched to the charging  $U_{\min\_D}$ .

The monitoring of the measured data is provided by the graphic recording to the Waveform graph placed on a virtual front panel in a LabVIEW program. There are recorded all four cell voltage waveforms and the current waveform. Apart from a continuous display of the measured data and control signals for charging or discharging on the front panel, the data are also recorded directly into the archive file. The data serve for displaying the charge and discharge waveforms, and if necessary, the data can be subjected to further analysis.

## RESULTS AND DISCUSSION

The measuring workplace in operation is shown in Fig. 4. The example of the measured data record for a period of 1200 minutes, which corresponds to three charge and discharge cycles, is shown in Fig. 5.

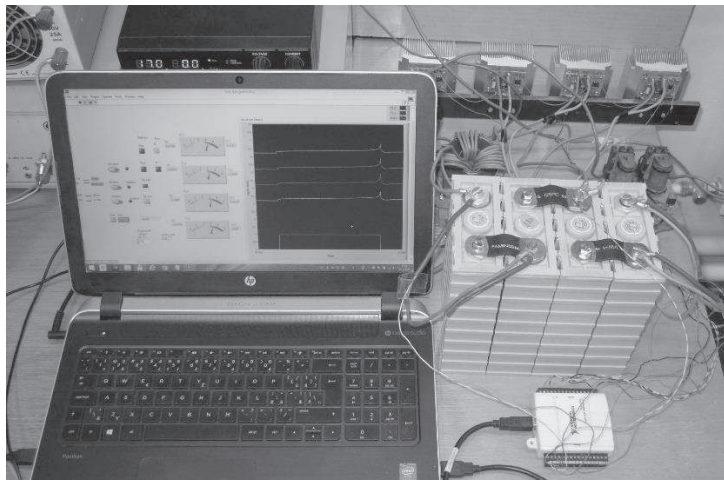

**Figure 4.** Photo of a measuring workplace.

Parameter measurements are performed by a cyclic discharge of the cells to a predefined minimum voltage and their recharge to a predefined maximum voltage. Gradually deteriorating battery parameters during hundreds of cycles are being monitored and evaluated.

There were tested commercially available Winston batteries, model WB-LYP40AHA, with a nominal capacity of 40 Ah (Winston Battery, 2017a) on the batteries with four in series-connected cells.

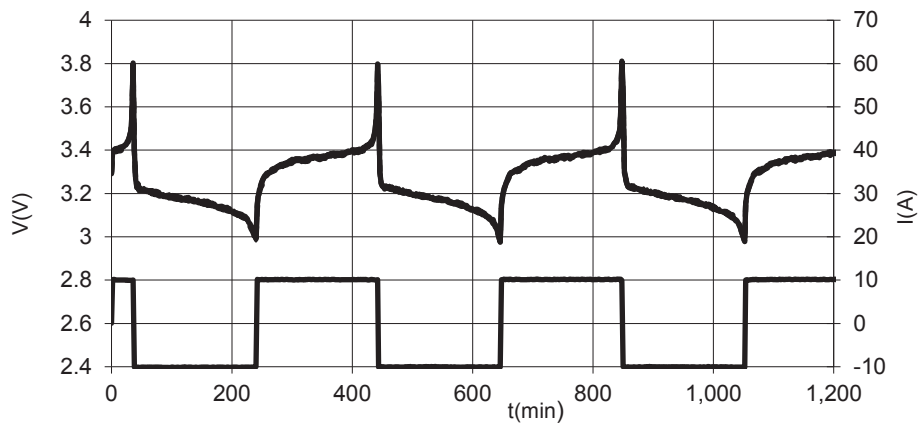

**Figure 5.** Example of the measured voltage (the upper curve) and current (the lower curve) waveforms on the cells within 1,200 minutes.

One battery was operated at the limits provided by the manufacturer with the DOD = 100%. Both charging and discharging currents were chosen the same, i.e., 10 A, which corresponds to the current  $CA/4$  (Winston Battery), according with anticipated operational conditions as power backup of the alarm system. During a mains power failure the system takes the current of several tens of mA in the sleep mode but the current up to 10 A in the event of an alarm. The charging was controlled by the balancers and terminated after reaching the voltage, ranging from 3.95 V to 4 V, simultaneously by all the battery cells. The discharge terminated when the voltage of any of the cells dropped below 2.9 V. The cells were loaded by the deepest possible discharge within the done limits. The charge, corresponding to cell nominal capacity, is consumed from the cells during the discharge.

The batteries were placed in a heated laboratory at the temperature  $20 \pm 1 \text{ }^\circ\text{C}$  and the cells temperature was monitored by infrared thermography. View of the upper wall of the cell is shown in Fig. 6, a. Photo with a temperature field on the surface of cells is shown in Fig. 6, b. Temperature distribution along the axis designated L1–L2 is graphically illustrated in Fig. 6, c. The temperature of individual cells differ by  $0.4 \text{ }^\circ\text{C}$ , the maximum temperature deviation of the cells from room temperature in the laboratory is  $1.1 \text{ }^\circ\text{C}$ .

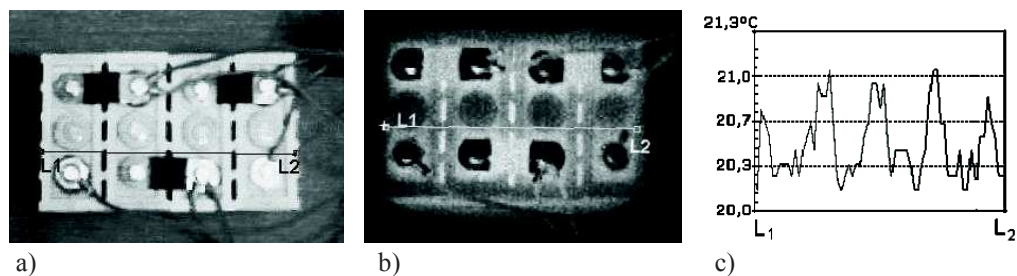

**Figure 6.** The temperature of the cells, a) real photo, b) infra photo, c) a distribution of temperature on the cells.

The electrical test results are shown in Table 1.

**Table 1.** Test results of 4 cells WB-LYP40AHA Winston Battery with DOD = 100%

After	Dischar. voltage (V)	Charging voltage (V)	Full discharge (Ah)	Full discharge (%)	Full charge (Ah)	Charging efficiency (%)	Capacity drop (Ah)
0 c.	11.94	15.8	46.3	115.8	46.6	99.3	
100 c.	11.94	15.9	44.4	111.0	45	98.6	1.9
200 c.	11.93	15.86	42.33	105.8	42.8	98.9	4.0
300 c.	11.87	15.85	41.3	103.3	41.7	99.1	5.0
400 c.	11.88	15.83	39.6	99.0	40	99.0	6.7
500 c.	11.89	15.8	37.2	93.0	37.9	98.1	9.1
600 c.	11.88	15.9	35.8	89.5	36.2	98.9	10.5
700 c.	11.87	15.86	35.	87.5	35.4	98.9	11.3
800 c.	11.87	15.85	33.8	84.5	34.1	99.1	12.5
900 c.	11.86	15.85	32.6	81.5	32.9	99.1	13.7
1,000 c.	11.86	15.84	31.4	78.5	31.7	99.0	14.9

The test results can be summarized as follows: after initialization charging, the capacity of all cells was approximately 46 Ah, during the next approximately 20 cycles, the capacity dropped about 0.03% per cycle. The drop further gradually decreased to the value of 0.017% per cycle, and then it remained constant until the test was completed. The drop of the capacity to 80% of the nominal capacity was recorded after 950 charging cycles and is shown in Fig. 7. The efficiency of the charge cycle throughout the whole test was for all cells practically constant, i.e. at 99%.

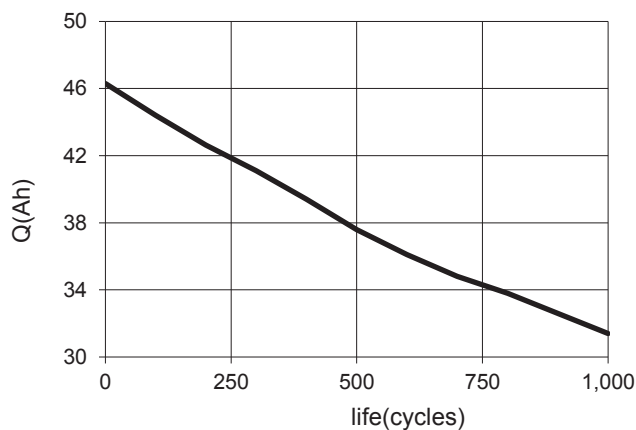

**Figure 7.** Drop of the capacity of cells operated with the DOD = 100%.

Second battery was operated at the limits provided by the manufacturer with the DOD = 50%. Both charging and discharging currents were chosen the same, i.e., 10 A, which corresponds to the current CA/4. The charging was controlled by the balancers and terminated after reaching the voltage, ranging from 3.95 V to 4 V, simultaneously by all the battery cells. The cells with nominal capability 40 Ah were loaded by the charge 20 Ah and the voltage of the cells dropped approximately to 3.2 V.



The test results are shown in Table 2.

**Table 2.** Test results of 4 cells WB-LYP40AHA Winston Battery with DOD = 50%

After	Dischar. voltage (V)	Charging voltage (V)	Full discharge (Ah)	Full discharge (%)	Full charge (Ah)	Charging efficiency (%)	Capacity drop (Ah)
0 c.	12.87	15.24	45.00	112.5	45.50	98.90	
100 c.	12.87	15.28	44.55	111.4	45.08	98.81	0.45
200 c.	12.86	15.26	44.10	110.3	44.56	98.98	0.90
300 c.	12.85	15.13	43.67	109.2	44.15	98.93	1.33
400 c.	12.86	15.20	43.26	108.2	43.72	98.96	1.74
500 c.	12.86	15.18	42.86	107.1	43.33	98.91	2.14
600 c.	12.87	15.22	42.48	106.2	42.98	98.83	2.52
700 c.	12.87	15.15	42.11	105.3	42.53	99.01	2.89
800 c.	12.86	15.15	41.74	104.4	42.23	98.83	3.26
900 c.	12.87	15.09	41.39	103.5	41.83	98.95	3.61
1,000 c.	12.86	15.10	41.05	102.6	41.49	98.94	3.95
1,100 c.	12.86	15.13	40.72	101.8	41.18	98.89	4.28
1,200 c.	12.87	15.15	40.40	100.0	41.86	98.88	4.60
1,300 c.	12.86	15.18	40.09	100.2	40.49	98.92	4.91
1,400 c.	12.86	15.19	39.79	99.5	40.20	89.99	5.21

The test results can be summarized as follows: after initialization charging, the capacity of all cells was approximately 45 Ah, during the next approximately 20 cycles, the capacity dropped 0.015 per cycle. The drop further gradually decreased to the value of 0.01% per cycle, and then it remained constant until the test was completed. The drop of the capacity to 90% of the initial capacity was recorded after 1,000 charging cycles and is shown in Fig. 8.

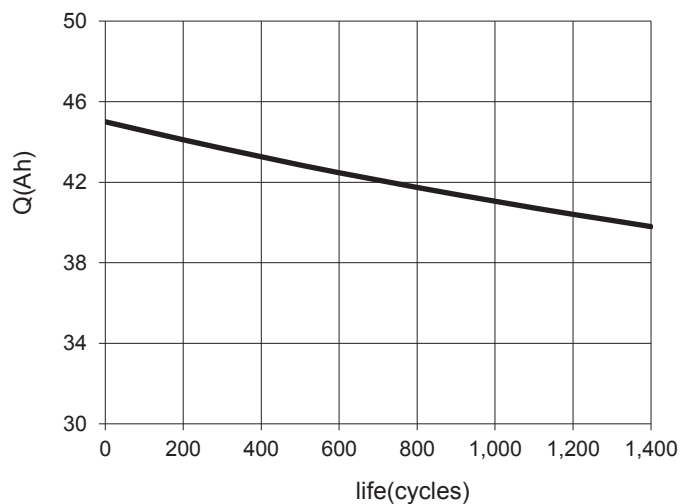

**Figure 8.** Drop of the capacity of cells operated with the DOD = 50%.



The given capacity and its drop correspond to the expected lifetime of 4,000–5,000 cycles. The efficiency of the charge cycle throughout the whole test was for all cells practically constant, i.e. at 99%.

## CONCLUSIONS

The batteries were tested on two automated testing stations (Papez & Papezova, 2016), which were upgraded using the balancers with very low internal resistance and a galvanic isolated current transducer. For the discharge control with the preset DOD, the control program was completed with the function of continuous evaluation of the consumed charge. Two tests with 1,000 and 1,400 discharge cycles were performed at two four-cell batteries of the type WB-LYP40AHA Winston Battery during one-year period of time. There were verified voltage waveforms of both sets during charge and discharge by a constant current in the range of voltage levels recommended by the manufacturer. Their ampere-hour capacity and charging efficiency was also determined.

The lifetime of the first battery with 100% DOD relative to 80% of the nominal capacity of the worst cell was set to 950 cycles. The lifetime of the second battery with a DOD of 50% relative to 80% of the nominal capacity of the worst cell was calculated on 3800 cycles according to the measurement results. The measured maximal initial capacity of the cell was 46.3 Ah at a discharge current of 0.25 CA. The manufacturer indicates the battery capacity of the cell of approximately 110% of the nominal capacity at a discharge current of 0.5 CA in the datasheet (Winston-Battery, 2017b). Manufacturer probably elects a greater initial capacity of the battery for reliable security of a guaranteed cell lifetime.

Valve Regulated Lead-Acid batteries (VRLA batteries) 12 V, 40 Ah (Reddy, 2010) has the lifetime of 300 cycles at 100% DOD and the lifetime of 900 cycles at 50% DOD. An acquisition cost of VRLA battery is approximately equal to 45% of acquisition cost of LiFePO<sub>4</sub> battery with the same parameters 12 V, 40 Ah. The comparison of these results shows that the operating costs of LiFePO<sub>4</sub> battery are definitely lower. But there is necessary to respect that LiFePO<sub>4</sub> battery has a slightly higher operating voltage and requires strict compliance of the prescribed operational mode.

ACKNOWLEDGEMENTS. Thanks for cooperation belong to Laboratory of Photovoltaic Systems Diagnostics, Faculty of Electrical Engineering, Czech Technical University in Prague and Department of Electrical Engineering and Automation, Faculty of Engineering, Czech University of Life Sciences in Prague.

## REFERENCES

- Cenek, M. Jindra, J., Jon, M., Kazelle, J., Kozumplík, J. & Vrba, J. 2003. *Accumulator from principle to practice*. FCC Public. Praha. 248 pp. (in Czech).
- Kreidl, M. & Svarc, R. 2006. *Technic Diagnostic*. BEN – technická liteartura. Praha. 408 pp. (in Czech).
- Liberty Electric Bikes. <http://www.iloveebikes.com/batteries.html>. Accessed 23.1.2017.
- Lust, R. 2010. *Accumulator Capacity Measurement*. Bachelor's thesis. VUT Brno. Supervisor Kolka.Z. 36 pp. (in Czech).
- Papez, V. & Papezova, S. 2016. Automated measuring station for accumulator testing. *Agronomy Research* **14**(S1), 1212–1221.

- Reddy, T. 2010. *Linden's Handbook of Batteries*. McGraw Hill Professional. New York, 1456 pp.
- Scrosati, B., Abraham, M., Schalkwijk, W. & Hassoun, J. 2013. *Lithium Batteries Advanced Technologies and Applications*. Wiley. New Jersey. 392 pp.
- Sinopoly Battery Limited. <http://www.sinopolybattery.com/en/products.aspx?cid=10&pages=1>, Accessed 23.1.2017.
- Srovnal, V. 2002. *Electrotechnical Measurements*. BEN – technická literatura. Praha. 255 pp. (in Czech).
- Thundersky Product Manual [http://www.thunderstruckev.com/Manuals/Thundersky\\_Product\\_Manual.pdf](http://www.thunderstruckev.com/Manuals/Thundersky_Product_Manual.pdf). Accessed 23.1.2017.
- Winston-Battery. <http://en.winston-battery.com/index.php/products/power-battery/category/lyp-battery>. Accessed 23.3.2017.
- Winston-Battery. <http://en.winston-battery.com/index.php/products/power-battery/item/wb-lyp-40aha>. Accessed 11.4.2017.