

ST4000+ **Wheel & Tiller** **Autopilots** Owner's Handbook

Document number: 81131-7
Date: April 2004

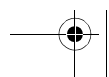

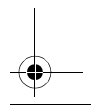
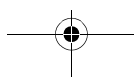
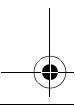
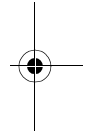
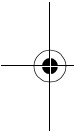
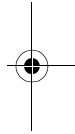
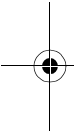
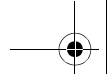

Autohelm, HSB (High Speed Bus), SailPilot, SeaTalk and SportPilot are registered trademarks of Raymarine Ltd.

Raymarine, AST (Advanced Steering Technology), AutoAdapt, AutoLearn, AutoRelease, AutoSeastate, AutoTack, AutoTrim, FastTrim, GyroPlus, RayGyro, RayPilot and WindTrim are trademarks of Raymarine Ltd.

Handbook contents © Raymarine Ltd 2004.

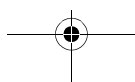



Contents

Important Information	vii
Warranty	vii
Safety notices	vii
EMC conformance	viii
Handbook information	viii
Chapter 1: Introduction	1
1.1 Features	1
1.2 Extended systems	2
Chapter 2: Basic Operation	3
2.1 Using the control unit	3
Key functions	3
Display layout	4
2.2 Using Auto mode	5
Engaging the autopilot (Auto mode)	5
Disengaging the autopilot (Standby mode)	6
Changing course in Auto mode	7
Dodging obstacles in Auto mode	7
Automatic tack (AutoTack)	8
Making major course changes	8
Gusting conditions	9
2.3 Adjusting autopilot performance	9
Changing the response level (AutoSeastate)	9
Changing the rudder gain	10
2.4 Autopilot alarms	11
Responding to alarms	11
2.5 Adjusting display and keypad lighting	14
Chapter 3: Advanced Operation	15
3.1 Using Track mode	15
Selecting Track mode	15
Exiting Track mode	17
Cross track error	17
Tidal stream compensation	18
Waypoint arrival and advance	19
Dodges in Track mode	20
Safety in Track mode	21
3.2 Using Wind Vane mode	22
Selecting Wind Vane mode	22
Exiting Wind Vane mode	23



- Adjusting the locked wind angle 23
- Dodges in Wind Vane mode 23
- Wind shift alarm 24
- Using AutoTack in Wind Vane mode 24
- Operating hints for Wind Vane mode 25
- 3.3 Displaying data pages 25

Chapter 4: Maintenance & Fault Finding 27

- 4.1 Fault finding 27
- 4.2 General maintenance 28
 - Wheel drive 28
 - Control unit 31
 - EMC advice 31
- 4.3 Product support 32
 - Software version 32

Chapter 5: Installing the ST4000+ 33

- 5.1 Planning the installation 34
 - Tools required and parts supplied 34
 - EMC installation guidelines 36
- 5.2 Control unit 38
 - Location 38
 - Mounting procedure 39
 - Cable connectors 41
 - Power supply connection 41
 - SeaTalk connections 42
 - NMEA connections 43
- 5.3 Fluxgate compass 45
 - Location 45
 - Mounting 47
 - Connecting to the control unit 48
- 5.4 Tiller drive (tiller pilots only) 49
 - Critical dimensions 49
 - Basic installation 50
 - Installation accessories 51
 - Connecting to the control unit 58
- 5.5 Wheel drive (wheel pilots only) 60
 - Installation stages 60
 - Drilling the spoke clamp holes 61
 - Securing the wheel drive to the wheel 64
 - Attaching the pedestal bracket 65
 - Connecting to the control unit 69



5.6 Rudder position sensor (wheel pilot)	71
Ensuring correct alignment	71
Securing the sensor to the boat	73
Attaching the sensor to the tiller arm	73
Checking alignment	74
Connecting to the control unit	74

Chapter 6: Setting-up the ST4000+ 75

6.1 Functional test	75
Switch on	75
Autopilot steering direction	76
Checking connections	77
6.2 Check rudder sensor operation (if fitted)	79
6.3 Initial sea trial	80
Correcting the compass deviation	81
Adjusting the heading alignment	84
Checking autopilot operation	85
Checking the rudder gain	85
6.4 Autopilot calibration techniques	87
Step 1 - Switch on ancillary equipment	87
Step 2 - Apply initial settings	87
Step 3 - Adjust the rudder damping	88
Step 4 - Adjust the rudder gain	88
Step 5 - Adjust the AutoTrim setting	88
Step 6 - Further adjustments	88

Chapter 7: Customizing the ST4000+ 89

7.1 User setup	90
Compass deviation correction (SWING COMPASS)	90
Deviation display (DEVIATION)	90
Heading alignment (ALIGN HDG)	90
Heading mode (HDG MAG/TRU)	90
Bar selection (RUDD BAR/STEER BAR/NO BAR)	92
Data pages 1-7 (DATA PAGE)	92
7.2 Dealer setup	94
Calibration lock (CAL LOCK)	96
Pilot type (4000 WHL/TILL)	96
Rudder gain (RUDD GAIN)	96
Response level (RESPONSE)	96
Turn limit (TURN RATE)	96
Rudder alignment (ALIGN RUD)	96
Rudder limit (RUD LIMIT)	97

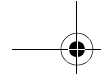

Off course alarm (OFF COURSE)	97
AutoTack angle (AUTOTACK)	97
AutoTrim (AUTOTRIM)	98
Drive type (DRIVE TYP)	98
Magnetic variation (VARIATION)	98
AutoAdapt (AUTOADAPT)	99
Latitude (LATITUDE)	99
Rudder damping (RUDD DAMP)	100
Cruise speed (CRUISE SP)	100
Specifications	101
Glossary	103
Index	105

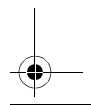
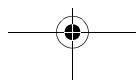
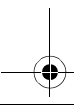
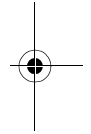
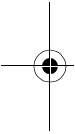



Important Information

This handbook contains important information about installing, using and maintaining your new Raymarine product. To get the best from the product, please read this handbook thoroughly.

Warranty

To register your new Raymarine product, please take a few minutes to fill out the warranty card. It is important that you complete the owner information and return the card to us to receive full warranty benefits.

Safety notices

WARNING: Product installation

This equipment must be installed and operated in accordance with the instructions contained in this handbook. Failure to do so could result in poor product performance, personal injury and/or damage to your boat.

WARNING: Electrical safety

Make sure the power supply is switched off before you make any electrical connections.

WARNING: Calibration

We supply this product calibrated to default settings that should provide stable performance for most boats. To ensure optimum performance on your boat, you must complete *Chapter 6: Setting-up the ST4000+* before use.

WARNING: Navigation aid

Although we have designed this product to be accurate and reliable, many factors can affect its performance. As a result, it should only be used as an aid to navigation and should never replace common sense and navigational judgement. Always maintain a permanent watch so you can respond to situations as they develop.

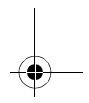
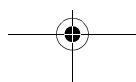
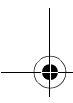
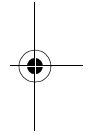
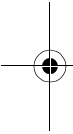

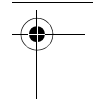
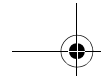

Your Raymarine autopilot will add a new dimension to your boating enjoyment. However, it is the skipper's responsibility to ensure the safety of the boat at all times by following these basic rules:

- Ensure that someone is present at the helm AT ALL TIMES, to take manual control in an emergency.
- Make sure that all members of crew know how to disengage the autopilot.
- Regularly check for other boats and any obstacles to navigation – no matter how clear the sea may appear, a dangerous situation can develop rapidly.
- Maintain an accurate record of the boat's position by using either a navigation aid or visual bearings.
- Maintain a continuous plot of your boat's position on a current chart. Ensure that the locked autopilot heading will steer the boat clear of all obstacles. Make proper allowance for tidal set – the autopilot cannot.
- Even when your autopilot is locked onto the desired track using a navigation aid, always maintain a log and make regular positional plots. Navigation signals can produce significant errors under some circumstances and the autopilot will not be able to detect these errors.

EMC conformance

All Raymarine equipment and accessories are designed to the best industry standards for use in the recreational marine environment. The design and manufacture of Raymarine equipment and accessories conform to the appropriate Electromagnetic Compatibility (EMC) standards, but correct installation is required to ensure that performance is not compromised.

Handbook information

To the best of our knowledge, the information in this handbook was correct when it went to press. However, Raymarine cannot accept liability for any inaccuracies or omissions it may contain. In addition, our policy of continuous product improvement may change specifications without notice. As a result, Raymarine cannot accept liability for any differences between the product and the handbook.

Chapter 1: Introduction

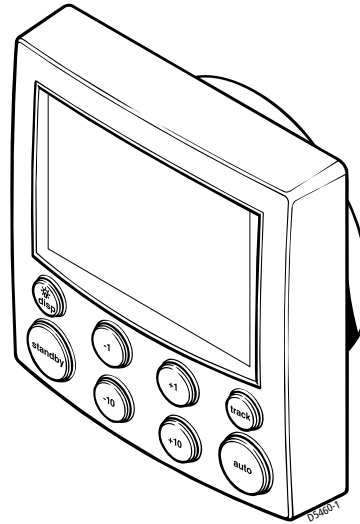

1.1 Features

The Raymarine ST4000 Plus (ST4000+) is a SeaTalk[®] compatible autopilot available in versions suitable for boats with either tiller or wheel steering systems. This autopilot system will steer your boat to a heading automatically, accurately and reliably.

The ST4000+ has four main operating modes:

1. **Standby:** autopilot off (see page 6)
2. **Auto:** autopilot engaged and locked onto a heading (see page 5)
3. **Track:** autopilot engaged and maintaining a track between two waypoints created using a navigation system (see page 15)
4. **Wind Vane:** autopilot engaged and maintaining a course relative to an apparent wind angle (see page 22)

The ST4000+ also provides the following features:

- automatic tack facility (AutoTack) in Auto and Wind Vane modes
- automatic compass deviation correction
- Northerly/Southerly heading compensation
- automatic heading deadband – seastate control
- waypoint advance feature
- setup and calibration options to optimize performance on your boat



1.2 Extended systems

The ST4000+ is compatible with all other SeaTalk instruments. You can connect it to additional fixed or handheld SeaTalk autopilot control units located at secondary steering and control positions (see *page 42*).

You can also use the ST4000+ autopilot with any navigator (GPS, Decca, Loran) or wind instrument that transmits data in the internationally-accepted National Marine Electronics Association (NMEA) 0183 format.

The ST4000+ can display SeaTalk and NMEA instrument data in a user-defined selection of data pages. When you are using the ST4000+ to repeat instrument data, it shows a 'pop-up' pilot page for 5 seconds whenever you make a change in autopilot control.

The ST4000+ can share all data transmitted from SeaTalk instruments:

- it can use wind information from a SeaTalk wind instrument for wind trim steering in Wind Vane mode without the need for a separate vane
- it can use track information from a SeaTalk navigation instrument to provide waypoint control in Track mode
- it can use boat speed from a SeaTalk speed instrument to optimize track-keeping performance

Rudder position sensor (wheel drives only)

On wheel drive systems a rudder position sensor is supplied to maximise pilot performance (see *page 71*). By using the information from the rudder angle sensor, the ST4000+ will also be able to show the true rudder angle in Standby and Auto modes.

Note: You *MUST* add a rudder position sensor if fitting the ST4000+ to a hydraulic steering system.

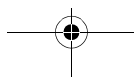

Chapter 2: Basic Operation

This chapter explain how to use the basic functions of your autopilot:

2.1 Using the control unit

Key functions

- The autopilot always powers up in Standby mode.
- You control the autopilot by pressing the buttons with each press being confirmed by a short beep.
- You access the main functions by pressing a single key:
- To access other functions you need to press two keys together:
- You can return to manual steering at any time by pressing **standby** and disengaging the autopilot (see *page 6*).

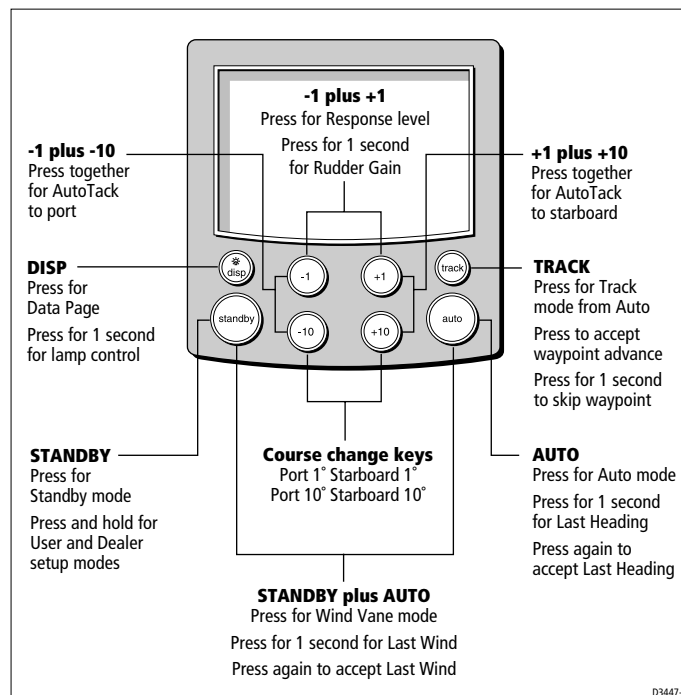

Display layout

The ST4000+ autopilot display provides the following information:

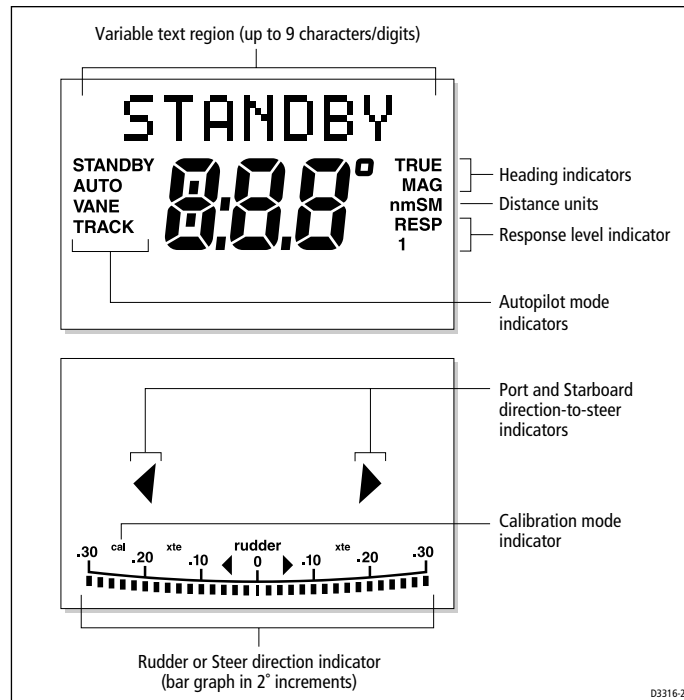

- If the display shows no distance unit all distances are in kilometres (Km), otherwise distances are in nautical miles (nm) or statute/land miles (SM).
- The bar graph at the bottom of the screen is normally a direction-to-steer indicator (you can change this in User setup, see *page 90*). The information displayed on the bar graph varies according to the autopilot mode:

Autopilot mode	Information displayed on bar graph
Standby	Rudder bar (only if a rudder position sensor is fitted)
Auto	Heading error bar
Track	Cross track error (XTE) bar, in 0.02 nm increments
Wind Vane	Wind angle error bar

2.2 Using Auto mode

Engaging the autopilot (Auto mode)

1. Steady the boat on the required heading.
2. **Wheel Pilot:** Engage the wheel drive clutch by rotating the clutch lever clockwise (so the lever **engages fully** onto the locating pip).
Tiller Pilot: Place the pushrod end over the tiller pin. If necessary, extend or retract the pushrod using the **-1**, **+1**, **-10** and **+10** keys.

WARNING: Wheel drive clutch

Always reach **AROUND** (not through) the wheel to operate the wheel drive clutch lever.

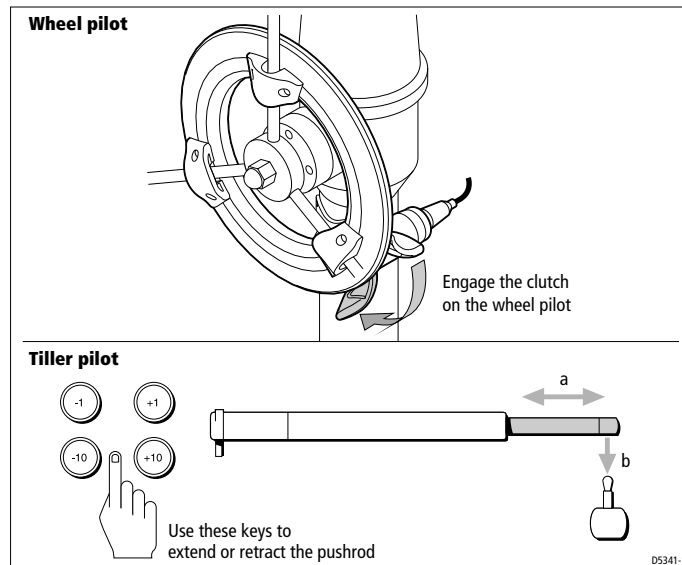

3. Press **auto**:
 - in Auto mode, the display shows the locked autopilot heading

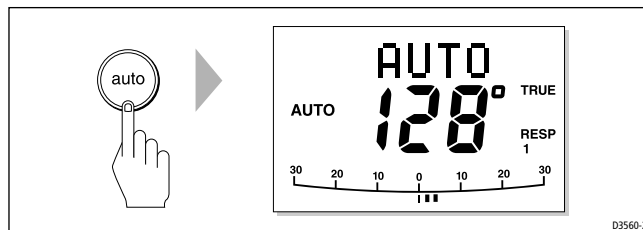

CAUTION:

Autopilot course control makes it easier to sail a boat, but it is **NOT** a substitute for good seamanship. **ALWAYS** maintain a permanent watch, no matter how clear the sea appears to be.

Disengaging the autopilot (Standby mode)

1. Press **standby**.
 - The display shows the boat's current compass heading.

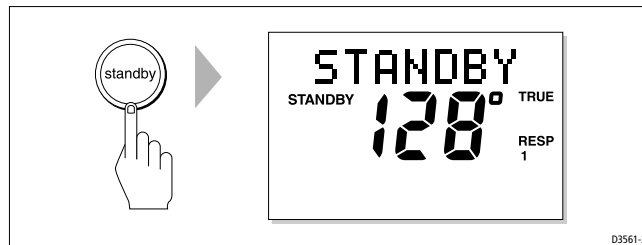

2. Disengage the autopilot to return to hand steering:
 - **Wheel Pilot:** Disengage the wheel drive clutch by rotating the clutch lever anti-clockwise (so the lever **engages fully** onto the locating pip).
 - **Tiller Pilot:** Remove the drive unit from the tiller pin. If required, retract the push rod using **-1, +1, -10** and **+10** keys.

CAUTION: Wheel drive systems

On wheel drive systems, always make sure that the clutch is **FULLY DISENGAGED** before you leave the boat.

Changing course in Auto mode

In Auto mode, use the **-1** and **-10** (port) and **+1** and **+10** (starboard) keys to change the locked heading in steps of 1° or 10°. For example: press **-10** three times for a 30° course change to port.

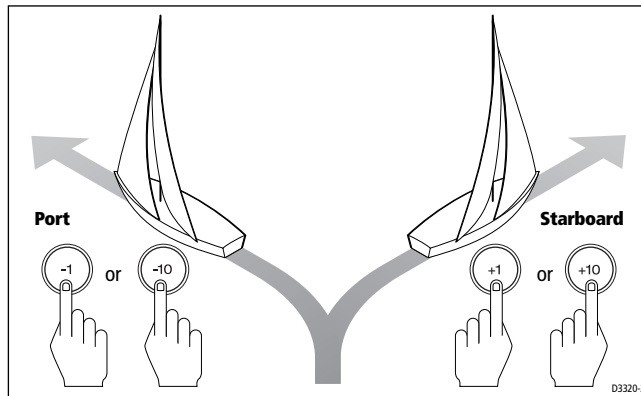

Dodging obstacles in Auto mode

To avoid an obstacle when your boat is under autopilot control:

1. Select a course change in the appropriate direction. For example, press **-10** three times for a 30° dodge to port.

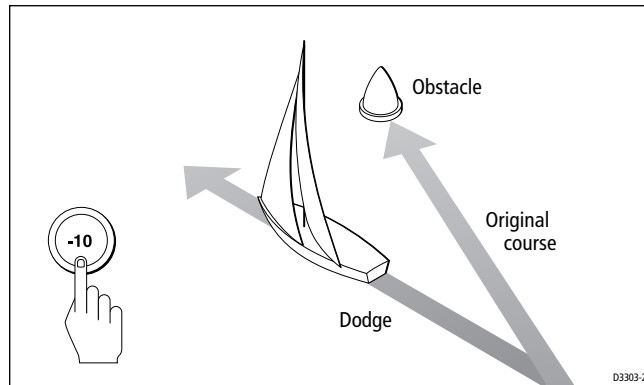

2. When safely clear of the obstacle, you can either:
 - reverse the previous course change (for example, press **+10** three times), or
 - return to the previous locked heading (LAST HDG)

Automatic tack (AutoTack)

The ST4000+ has a built in automatic tack facility (AutoTack) that turns the boat through a pre-determined angle in the required direction. The default AutoTack angle is 100°, but you can adjust this in Dealer setup (see *page 97*).

- to AutoTack to **port**: press the **-1** and **-10** keys together
- to AutoTack to **starboard**: press the **+1** and **+10** keys together

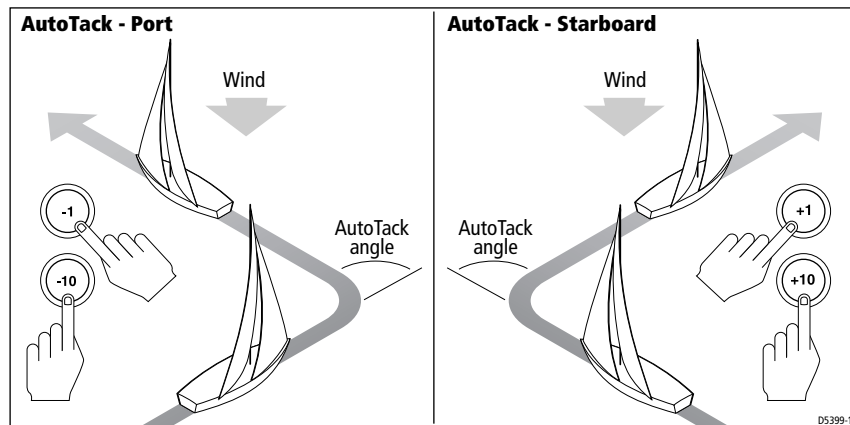

Making major course changes

CAUTION:

Only make major course changes when steering MANUALLY. This ensures that the boat will safely clear any obstructions or other boats, and you can take into account the changed wind and sea conditions on the new heading before engaging the autopilot.

Large course changes which change the apparent wind direction can produce large trim changes. When a sudden trim change occurs (for example due to weather helm or sail imbalance) there will be a delay of up to one minute before the automatic trim applies rudder to restore the locked heading.

In these situations, the autopilot will not immediately assume the new automatic heading, and will only settle onto course when the automatic trim has been fully established. To eliminate this problem, use the following procedure to make major course changes:

1. Note the required new heading.
2. Select **standby** for manual steering, so you can bring the boat to the new heading MANUALLY.
3. Select **auto**: allow the boat to settle onto course, then bring the boat to the final course in 1° steps using the **-1** or **+1** keys

Gusting conditions

In gusting conditions, the course may tend to wander slightly, particularly if the sails are badly balanced. If you take the following precautions, the autopilot will be able to maintain competent control even in gale force conditions:

- You can significantly improve course keeping by improving the sail balance:
 - do not allow the boat to heel over excessively
 - ease the mainsheet traveller to leeward to reduce heeling and weather helm
 - if necessary, reef the mainsail a little early
- In very strong winds and large seas, you should avoid sailing with the wind dead astern:
 - ideally, bring the wind at least 30° away from a dead run
 - in severe conditions, you may also need to remove the mainsail and sail under headsail only

2.3 Adjusting autopilot performance

During normal autopilot operation in any mode you can make **temporary** adjustments to the response level and rudder gain

Note: *You will lose these temporary changes to response level and rudder gain whenever the system is powered off then on again. You can make **permanent** adjustments in Dealer setup (see page 94).*

Changing the response level (AutoSeastate)

The response level controls the relationship between the autopilot's course keeping accuracy and the amount of helm/drive activity.

- **Response Level 1: AutoSeastate on (Automatic deadband)**
This setting causes the autopilot to gradually ignore repetitive boat movements and only react to true variations in course. This

provides the best compromise between power consumption and course keeping accuracy, and is the default calibration setting.

- **Response Level 2: AutoSeastate off (Minimum deadband)**

This setting provides the tightest course keeping possible. However, tighter course keeping results in increased power consumption and drive unit activity.

To make a **temporary** change to the response setting:

1. Display the RESPONSE screen by pressing the **-1** and **+1** keys together momentarily.

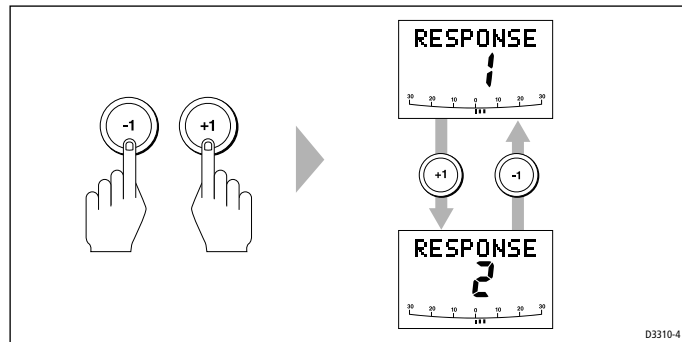

Note: If you have set up the RESPONSE screen as a default data page (see page 92) you can also access it by pressing **disp** and then scrolling through the data pages.

2. Press **-1** or **+1** to change the response level.
3. Press **disp** or wait for 5 seconds to return to the previous display.

Changing the rudder gain

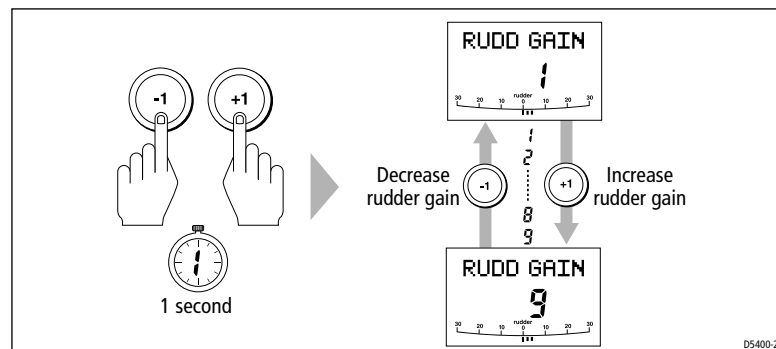

To make a **temporary** change to the rudder gain:

1. Press the **-1** and **+1** keys together for **1 second** to display the rudder gain (RUDD GAIN) screen

Note: *If you have set up the RUDD GAIN screen as a default data page (see page 92) you can also access it by pressing **disp** and then scrolling through the data pages.*

2. Press **-1** or **+1** to change the rudder gain.
3. Press **disp** or wait for 5 seconds to return to the previous display.

Note: *See page 85 for instructions on how to check that the rudder gain is set correctly.*

2.4 Autopilot alarms

Responding to alarms

The ST4000+ activates the alarms listed on the following pages:

- Unless otherwise stated, you should deal with alarms by pressing **standby** to clear the alarm and return to hand steering.
- In some situations, the autopilot will raise more than one alarm. When you have dealt with the first alarm, the autopilot will display the next alarm.

SeaTalk Failure alarm (STLK FAIL)

The ST4000+ displays the SeaTalk failure message if there is a wiring fault in the SeaTalk connection.

Off Course alarm (OFFCOURSE)

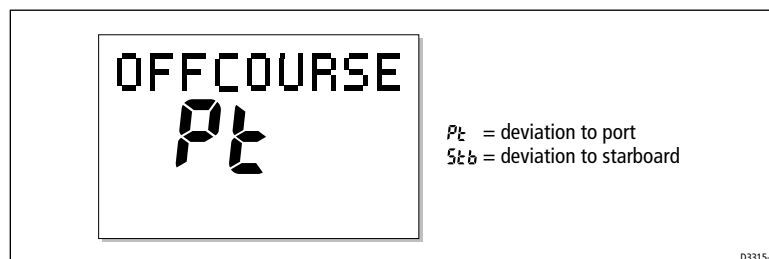



The ST4000+ activates this alarm when the boat has been off course from the locked heading by more than the specified angle* for longer than 20 seconds. It shows whether the deviation is to port or starboard.

Note: * You can adjust this specified alarm angle in Dealer setup (see page 94).

1. To cancel the off course alarm, press **standby**.
2. Check whether your boat is carrying too much sail, or whether the sails are badly balanced. You can usually significantly improve course keeping by improving the sail balance.

Note: The ST4000+ also clears the alarm if the heading recovers, if you change the course, or if you change the operating mode.

Wind Shift alarm (WINDSHIFT)

The ST4000+ activates the Windshift alarm when it detects a change in the apparent wind angle of more than 15° (see page 24).

Large Cross Track Error alarm (LARGE XTE)

The ST4000+ activates this alarm when the cross track error exceeds 0.3 nm (see page 17). The alarm clears if the heading recovers, if you change the course, or if you change the operating mode.

Drive Stopped alarm (DRIVESTOP)

The ST4000+ activates this alarm if:

- the rudder position sensor fails, or
- the autopilot is unable to turn the rudder (this occurs if the weather load on helm is too high, or if the rudder position sensor has passed beyond the preset rudder limits or rudder end-stops)

Data Not Received alarm (NO DATA)

The ST4000+ activates this alarm in any of the following situations:

- the compass is not connected
- the autopilot is in Wind Vane mode and it has not received wind angle data for 30 seconds
- the autopilot is in Track mode and:
 - the boat has arrived at the last waypoint in the track, or
 - the autopilot is not receiving SeaTalk navigation data, or

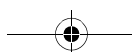

- the position sensor (GPS, Loran, Decca) is receiving a low strength signal – this will clear as soon as the signal improves

The autopilot stops adjusting the heading as soon as it loses data.

Waypoint Advance alarm (NEXT WPT?)

The ST4000+ activates the Waypoint Advance alarm whenever the target waypoint number changes. This occurs when:

- you select automatic acquisition by pressing **track** from Auto
- you request waypoint advance by pressing **track** for 1 second in Track mode (with SeaTalk navigators only)
- the boat arrives at the target waypoint and the navigator accepts the next waypoint
- you activate the Man Overboard (MOB) function in Track mode

When the alarm sounds, the pilot continues on its current heading but displays:

- the bearing to the next waypoint
- the direction the boat will turn to take up that bearing

Responding to a Waypoint Advance alarm

To respond to a Waypoint Advance alarm:

- check that it is safe to turn onto the new track, then press **track** to accept the waypoint advance
- alternatively, you can cancel the alarm without accepting the waypoint advance by pressing: **standby** to return to hand steering, or **auto** to return to Auto mode.

Note: *Waypoint advance only operates if the ST4000+ is receiving valid bearing to waypoint and waypoint number information.*

Shallow alarm (SHALLOW)

The ST4000+ activates the Shallow alarm if it receives a shallow depth alarm via SeaTalk:

- press **standby** or **disp** to cancel the alarm

Man Overboard alarm (MOB)

The ST4000+ activates the Man Overboard alarm if it receives a man overboard (MOB) message from another instrument on the SeaTalk

system. It displays the text MOB instead of the waypoint number for the XTE, DTW and BTW data pages.

If the autopilot is in Track mode, it will sound the Waypoint Advance alarm to notify you of the change in waypoint.

2.5 Adjusting display and keypad lighting

Note: When the display lighting is off, the control unit still illuminates the keys at a courtesy level.

To adjust the display and keypad lighting:

1. Press **disp** for 1 second from any mode to access the LAMP screen and turn on the lights.
2. Press the **disp** key to cycle through the illumination settings:

Note: LAMP 3 is the brightest setting.

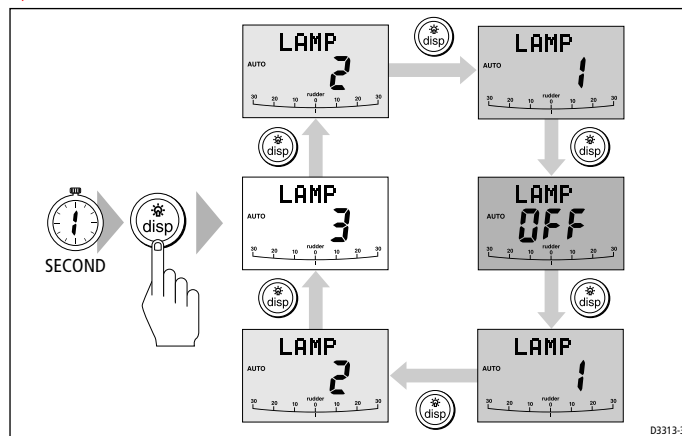

3. The display automatically returns to the previous mode if you do not press a key for 7 seconds:
 - if you press another mode key within 7 seconds you will select the mode assigned to that key (for example: **auto** selects Auto mode, **standby** selects Standby mode)

Note: You can also adjust the lighting level from any other SeaTalk instrument or control unit connected to SeaTalk.

Note: When you switch off the unit you lose any changes you have made to the lighting.



Chapter 3: Advanced Operation

This chapter explain how to use the more advanced functions on your autopilot:

3.1 Using Track mode

Note: *You can only use Track mode if you have connected the ST4000+ to a suitable navigation system providing SeaTalk or NMEA navigation information.*

The ST4000+ can receive track and cross track error information from either:

- a SeaTalk navigation instrument or chartplotter (see *page 42* for information on connecting to SeaTalk)
- or
- a non-SeaTalk navigation system transmitting data in the NMEA 0183 format – you can connect this directly to the ST4000+ NMEA input (see *page 43* for information on connecting to NMEA equipment)

In Track mode, the ST4000+ maintains a track between two waypoints created on the navigation system. The autopilot computes any course changes to keep your boat on track, automatically compensating for tidal streams and leeway.

Selecting Track mode

To select Track mode, press the **track** key with the autopilot in Auto mode.

When you select Track mode, the autopilot can acquire a track through either:

- automatic acquisition (see below), when both cross track error (XTE) and bearing to waypoint (BTW) data are available
- or
- manual acquisition (see *page 16*), when only cross track error information is available

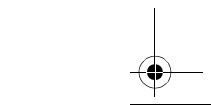
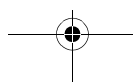
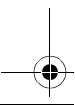
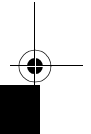
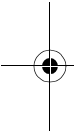

Automatic track acquisition

If cross track error and bearing to waypoint information are both available (via SeaTalk or NMEA), the autopilot can acquire a track automatically:

1. Bring the boat within 0.1 nm of track.
2. Press **auto**. The autopilot will display the current locked heading.
3. Press **track** to enter Track mode.
4. Wait for the Waypoint Advance alarm to sound. The display will show the bearing to the next planned waypoint and the direction the boat will turn to reach this waypoint.

Note: If the boat is more than 0.3 nm from the track, the Large Cross Track Error alarm will sound (see page 17). Press **standby** to cancel the alarm, hand steer closer to the track, press **auto** and then press **track**.

5. Check that it is safe to turn the boat onto the new course.
6. Press the **track** key:
 - the boat will turn onto the new course
 - the display shows the new bearing to waypoint

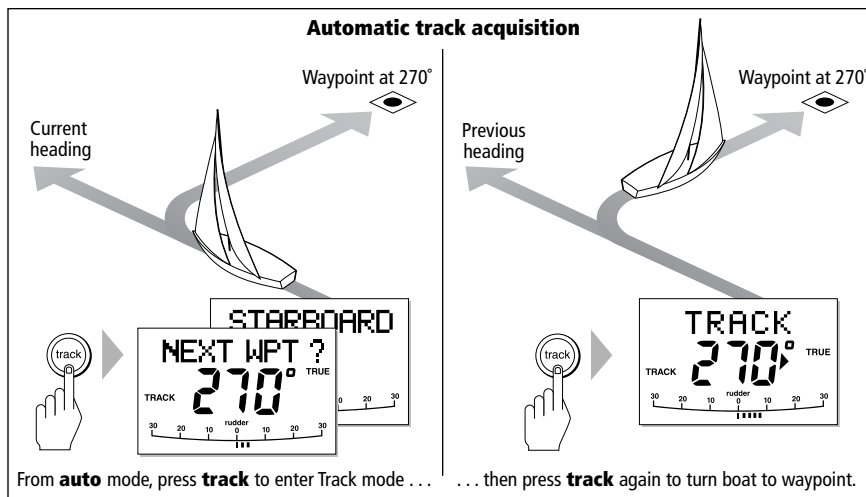

Manual track acquisition

If your navigation system only provides cross track error information, you must acquire the track manually:



1. Steer the boat to within 0.1 nm of track.
2. Bring the heading to within 5° of the bearing to the next waypoint.
3. Press **auto**.
4. Press **track** to enter Track mode. The display then shows the locked pilot heading.

Note: *Tidal streams have a far more significant effect at lower speeds than at higher speeds. If the tidal flow is less than 35% of the boat's speed, you will not notice any difference in the autopilot's performance in Track mode. However, you should take extra care during manual acquisition, as follows:*

- *Before you select Track mode, make sure the boat is as close as possible to track, and the direction made good over the ground is as close as possible to the direction of the next waypoint.*
- *Make positive checks of the boat's position at regular intervals, especially if you are close to potential navigational hazards.*

Exiting Track mode

You can return to either Auto or Standby mode from Track mode by:

- pressing **auto** to return to Auto mode
- pressing **standby** to return to manual steering

Cross track error

Cross track error (XTE) is the distance between the current position and a planned route. The autopilot receives the cross track error information from the navigation equipment, and displays the XTE in nautical miles (nm), statute miles (SM) or kilometres.

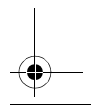
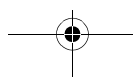
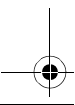
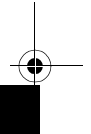
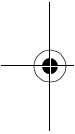

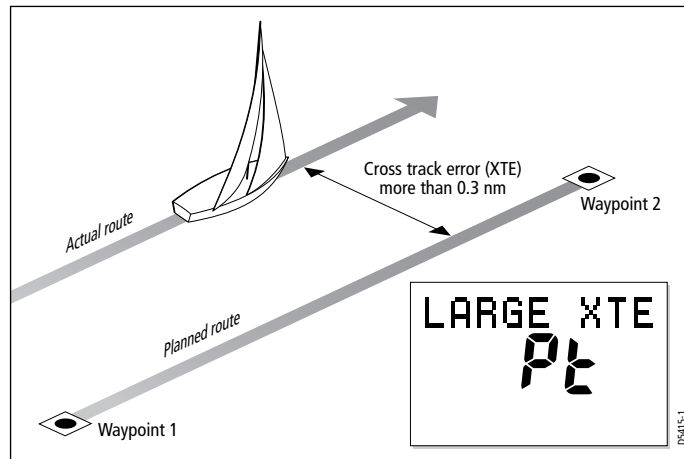

If the cross track error is greater than 0.3 nm, the ST4000+ will sound the Large Cross Track Error alarm and shows whether you are to the port (Pt) or starboard (Stb) of the planned track.

To cancel the Large Cross Track Error alarm:

- press **standby** to return to hand steering, or
- press **auto** to return to Auto mode and retain the current heading

Note: When the Large Cross Track Error alarm sounds, it usually means that the cross tide is too great for your boat's current speed.

Tidal stream compensation

Under most conditions, Track mode will hold the selected track to within ± 0.05 nm (300 ft) or better. The autopilot takes account of the boat's speed when computing course changes to ensure optimum performance over a wide range of boat speeds. In order of preference, the ST4000+ uses:

- measured boat speed (speed through water)
- if this is not available, it uses the speed over ground (SOG)
- if this is not available, it uses the cruise speed specified in Dealer setup (see page 94)

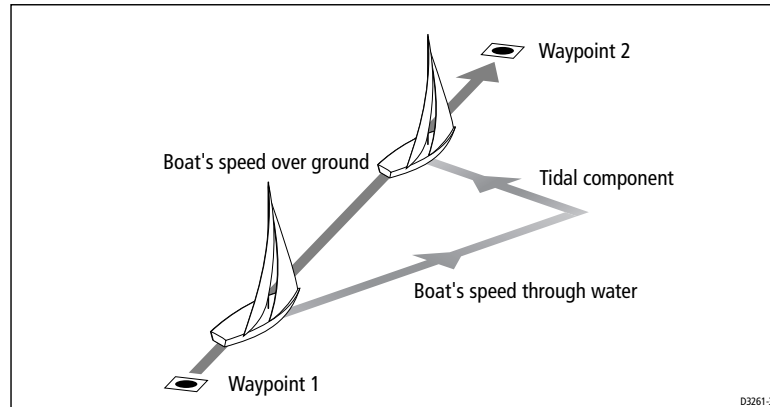

Waypoint arrival and advance

Arrival

As the boat arrives at the target waypoint the navigation aid should manually or automatically select the next target waypoint. The ST4000+ will then detect the new target waypoint number, sound the Waypoint Advance alarm and display the Waypoint Advance screen. This shows the new bearing to the next waypoint and the direction the boat will turn to acquire the new track.

Advance

When the ST4000+ sounds the Waypoint Advance alarm, it suspends Track mode and maintains the current boat heading. To advance to the next waypoint:

1. Check that it is safe to turn onto the new track.
2. Press the **track** key. This will cancel the Waypoint Advance alarm and turn the boat towards the next waypoint.

Note: If you do not press **track** to accept the Waypoint Advance, the ST4000+ will maintain the current heading and continue sounding the alarm.

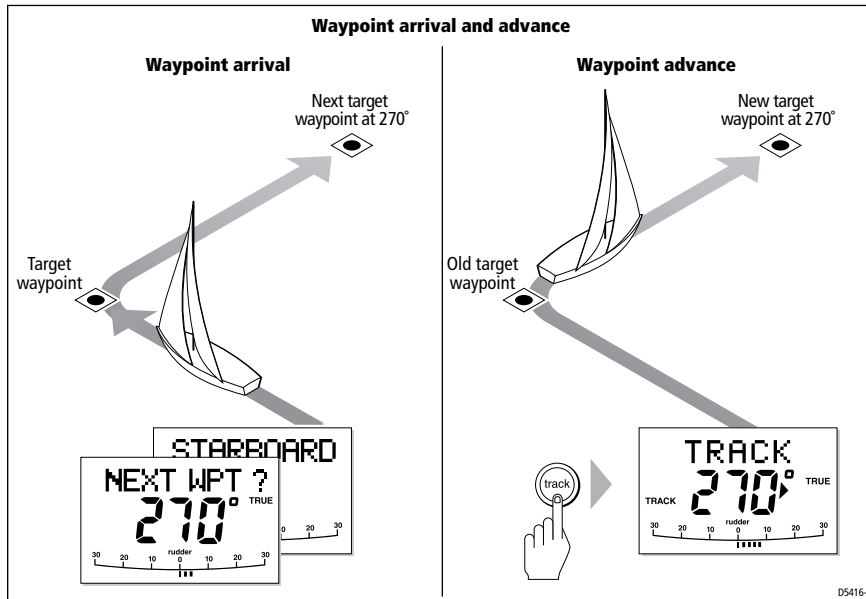

Note: When you reach the last waypoint in the track, the NO DATA alarm will sound to indicate that there is no further waypoint information. Press **auto** to continue on the same heading, or **standby** to return to hand steering.

Skipping a waypoint – SeaTalk navigators only

If you want to advance to the next waypoint **before** you have arrived at the target waypoint, you can skip a waypoint by pressing **track** for 1 second. The display will then show the Waypoint Advance screen for the next waypoint.

Dodges in Track mode

When the autopilot is in Track mode you still have full control from the keypad.



Initiating a dodge maneuver

In Track mode, you can make a dodge maneuver by using the course change keys (**-1**, **+1**, **-10** or **+10**) to select the desired course change.

Cancelling a dodge maneuver

After you have avoided the hazard, you can cancel the dodge course change by making an equal course change in the opposite direction.

Note: *Provided the boat remains within 0.1 nm of track, you do not need to steer back towards the track.*

Safety in Track mode

WARNING:

Track mode provides accurate track keeping even in complex navigational situations. However, it is still the skipper's responsibility to ensure the safety of their boat at all times through careful navigation and frequent position checks.

Sailing in Track mode assists precise navigation and removes the tasks of compensating for wind and tidal drift. However, you **MUST** still maintain an accurate log with regular plots.

Confirming position at the start of a journey

At the start of a journey you must always use an easily identifiable fixed object to confirm the fix given by the navigation system. Check for fixed positional errors and compensate for them.

Verifying computed positions

Always verify the computed position with a dead reckoned position, calculated from the average course steered and the distance logged.

Plot frequency

- In open water, you should make plots at least every hour.
- In confined waters or when near to potential hazards, you should make plots more frequently.

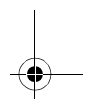
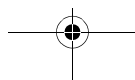
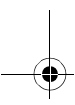
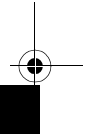
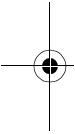



Setting waypoints

- Local variations in radio signal quality and changes in the tidal stream can produce deviations from the desired track. When setting waypoints, remember that deviations can occur.
- Thoroughly check along each track. Check up to 0.5 nm each side of the track to ensure that there are no hazards within this zone.

Note: For the waypoint advance function to work, the last four characters of adjacent waypoint names must be different.

3.2 Using Wind Vane mode

Note: You can only use Wind Vane mode if you have connected the ST4000+ to a suitable wind instrument/vane providing SeaTalk or NMEA wind direction information.

To use Wind Vane mode (also known as Vane mode), the ST4000+ must receive wind information from one of the following sources:

- SeaTalk wind instrument, connected to the ST4000+ via SeaTalk
- NMEA wind instrument
- Raymarine wind vane connected through a SeaTalk interface box

In Wind Vane mode the ST4000+ maintains a course relative to an apparent wind angle. It uses wind trim to eliminate the effects of turbulence and short term wind variations. This provides smooth and precise performance with minimal power consumption.

When the ST4000+ is in Wind Vane mode it uses the fluxgate compass as the primary heading reference. As changes in the apparent wind angle occur, the ST4000+ adjusts the locked compass heading to maintain the original apparent wind angle.

Selecting Wind Vane mode

You can select Wind Vane mode from either Standby or Auto mode:

1. Steady the boat onto the required apparent wind angle.
2. Press **standby** and **auto** together to select Wind Vane mode and lock the current apparent wind angle:
 - the display shows the locked heading (e.g. 128°) along with the apparent wind angle (e.g. WIND 145P indicates an apparent wind angle of 145° to port)

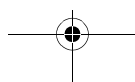

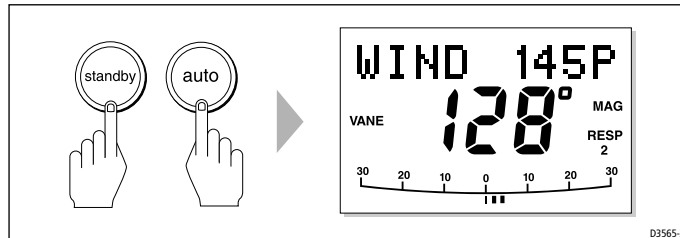

The ST4000+ will then adjust the boat's heading to maintain the locked apparent wind angle.

Exiting Wind Vane mode

You can return to Auto or Standby mode from Wind Vane mode by:

- pressing **auto** to return to Auto mode
- pressing **standby** to steer manually in Standby mode

Adjusting the locked wind angle

You can adjust the locked wind angle by using the **-1**, **+1**, **-10** and **+10** keys to change course. For example, to bear away by 10° when the boat is on a starboard tack:

- press **-10** to turn the boat 10° to port – the locked apparent wind angle and locked heading will both change by 10°
- the autopilot will then adjust the locked heading as required to maintain the new apparent wind angle

Note: *Because turning the boat affects the relationship between the true and apparent wind angles, you should only use this method to make **minor** adjustments to the apparent wind angle. For major changes, return to Standby mode, steer onto the new heading, then reselect Wind Vane mode.*

Note:

Dodges in Wind Vane mode

When the autopilot is in Wind Vane mode you still have full control from the keypad.



Initiating a dodge maneuver

In Wind Vane mode, you can make a dodge maneuver by using the course change keys (**-1**, **+1**, **-10** or **+10**) to select the desired course change. The autopilot will adjust both the locked heading and locked apparent wind angle.

Cancelling a dodge maneuver

After you have avoided the hazard, you can reverse the previous course change, or return to the previous wind angle (LAST WND?).

Wind shift alarm

If the autopilot detects a wind shift of more than 15° it will sound the wind shift alarm and display the WINDSHIFT alarm message (see page 9).

- To cancel the alarm and retain the existing wind angle and new heading:
 - press **standby** and **auto** together.
- Alternatively, to cancel the alarm and return to the previous heading, either:
 - adjust the locked wind angle using the **-1**, **+1**, **-10** and **+10** keys
 - or
 - press **standby** to return to hand steering, steer onto the required heading, and press **standby** and **auto** together to return to Wind Vane mode with the new apparent wind angle

Using AutoTack in Wind Vane mode

After using the AutoTack function (see page 8) to tack in Wind Vane mode, you may need to adjust the locked heading until you achieve the required apparent wind angle.

Note: Before you use the AutoTack function in Wind Vane mode, you must make sure that the wind vane was centered accurately at installation.

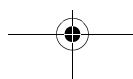
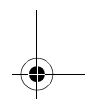
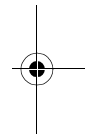

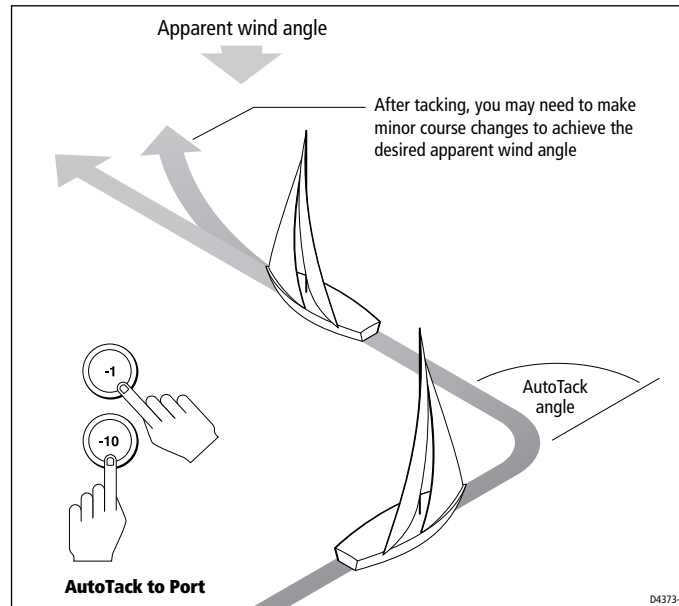

Operating hints for Wind Vane mode

- Always trim your sails carefully to minimize the amount of standing helm.
- Reef the headsail and mainsail a little early rather than too late.
- In Wind Vane mode the pilot will react to long-term wind shifts, but will not correct for short-term changes such as gusts.
- In gusty and unsteady inshore conditions, it is best to sail a few degrees further off the wind so that changes in apparent wind direction can be tolerated.

3.3 Displaying data pages

Use the **disp** key to show 'data pages' of SeaTalk or NMEA data:

1. Press **disp** to access the first data page, and press it again to cycle through each data page in turn:
 - to return to a previous data page, press **disp** for 1 second within 2 seconds of displaying a page
 - when you cycle past the last data page, the display returns to the current autopilot mode screen (for example, Auto)

2. Select the data page you want to use as the principle display on the control unit:

- the current autopilot mode is shown at the left of the display and the autopilot bar graph remains in use
- if you then select a new mode or make a course change, the autopilot mode screen appears as a 'pop-up' for 5 seconds

Three data pages are set in the factory as a default (see diagram). Within User setup you can select up to seven pages and control the information they display (see page 90):

- if the autopilot system cannot obtain the required information for a data page, the display will show dashes instead of a value
- the 'direction-to-steer' arrows relate to the data page information
- most data pages show repeated data so you cannot adjust them: the exceptions are the RESPONSE and RUDDER GAIN data pages (if you have selected them for display) which you can adjust using the **-1** and **+1** keys

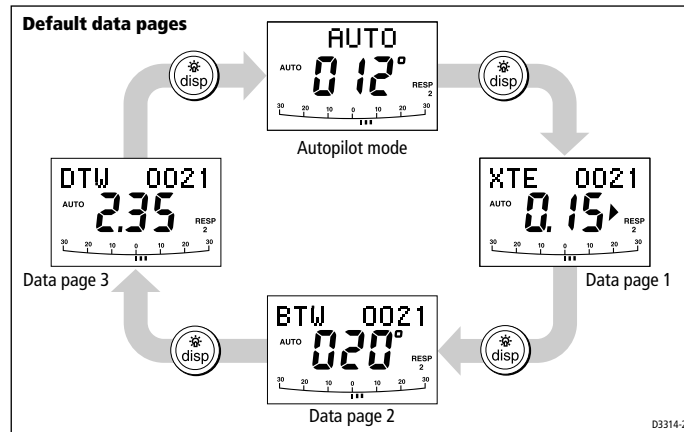

Chapter 4: Maintenance & Fault Finding

This chapter provides information about identifying common problems, maintaining your autopilot system and obtaining product support:

4.1 Fault finding

All Raymarine products are designed to provide many years of trouble-free operation. We also put them through comprehensive testing and quality assurance procedures before shipping.

In the unlikely event that a fault does occur with your autopilot, use the following table to help identify the problem and provide a solution.

If you cannot resolve the problem yourself, refer to the product support information on *page 32*.

SYMPTOM	SOLUTION
The control unit display is blank	No power – check the fuse/circuit breaker.
The displayed compass heading does not agree with the boat's compass	You have not corrected the compass for deviation – carry out the deviation and alignment procedures (see <i>page 81</i> and <i>page 84</i>).
Boat turns slowly and takes a long time to come onto course	Rudder gain too low (see <i>page 85</i>).
Boat overshoots when turning onto a new course	Rudder gain too high (see <i>page 85</i>).
The autopilot appears to be unstable in Track mode, or track-holding is slow	If tide speed exceeds 35% of boat speed, and boat speed is not available via SeaTalk, change the Cruise Speed setting in Dealer Setup to the boat's cruising speed (see <i>page 100</i>).
The autopilot appears to be unstable on Northerly headings in the Northern hemisphere and Southerly headings in the Southern hemisphere	Northerly/Southerly heading correction (AutoAdapt) is not set up (see <i>page 99</i>).
Display shows CAL LOCK when entering calibration	Calibration lock is on – turn off the calibration protection feature in Dealer setup (see <i>page 96</i>).

SYMPTOM	SOLUTION
The autopilot will not 'talk' to other SeaTalk instruments	Cabling problem – make sure all the cables are connected properly.
Position information not received	Navigator not transmitting the correct position data.
The autopilot will not auto advance to the next waypoint	No bearing to waypoint information received from the navigator.
The control unit display shows a series of rotating dashes	Compass deviation correction is running (see <i>page 81</i>).
The control unit display shows a series of stationary dashes	The control unit is not receiving data – check the cabling.
The control unit display shows NO DATA	The signals received by the navigator are too weak for reliable navigation – refer to the navigator handbook for further action. OR Wind trim data is not available – check the connection to the wind instrument.
Wheel drive: drive belt slips in Auto mode (motor operates but drive does not turn wheel)	Tighten the clutch – see <i>page 29</i> .
Wheel drive: drive belt drags in Standby mode	Loosen the clutch – see <i>page 29</i> .

4.2 General maintenance

CAUTION:

The control unit, fluxgate compass, tiller drive and rudder position sensor do not contain any user serviceable parts. These products should be serviced only by authorized Raymarine service technicians.

Wheel drive

Routine maintenance

After each trip, flush inside the drive unit by inserting a hose pipe in the free slot on the back cover.

Cleaning the wheel drive

CAUTION:

Do not use mineral-based solvents (such as WD40) to lubricate or clean the wheel drive as they will damage the material.

We recommend that you complete the following steps each season to prevent the build-up of salt on the wheel drive bearings and drive belt:

1. Remove the wheel drive from the wheel:
 - remove the wheel from the pedestal
 - remove the spoke clamp screws
 - remove the wheel drive front cover
2. Check inside the drive unit for any signs of damage.
3. Thoroughly flush the wheel drive interior with fresh water to remove any salt build-up on the bearings and drive belt.
Do not lubricate any part of the wheel drive. It is designed to run without lubrication.
4. Replace the front cover then fit wheel drive back onto the wheel.
5. Fit the wheel and wheel drive back onto the pedestal.
6. Clean the wheel drive case (using mild detergent if necessary), then flush thoroughly with fresh water.

Adjusting the clutch

You need to adjust the clutch if the drive belt slips in Auto mode or drags in Standby mode. In normal use, you can tell if the clutch is slipping if the motor operates but the drive does not turn the wheel.

To adjust the clutch, first make sure that the autopilot is in Standby mode and the clutch is disengaged. Then:

1. Use a 3 mm allen key (supplied) to loosen the clutch knob screw about 2 turns anti-clockwise.
2. Turn the clutch knob either 4 clicks clockwise to tighten the clutch, or 4 clicks anti-clockwise to loosen the clutch.
3. Use the allen key to re-tighten the clutch knob screw.
4. Check that the wheel still moves freely with the clutch off.

Note: *If the wheel does not move freely, reduce the clutch tension by turning the clutch knob 2 clicks anti-clockwise and check again*

5. Check the drive's operation with the clutch engaged.

This procedure is usually sufficient to correct a slipping or dragging drive belt. In some cases, however, you may need to repeat the steps to adjust the clutch further.

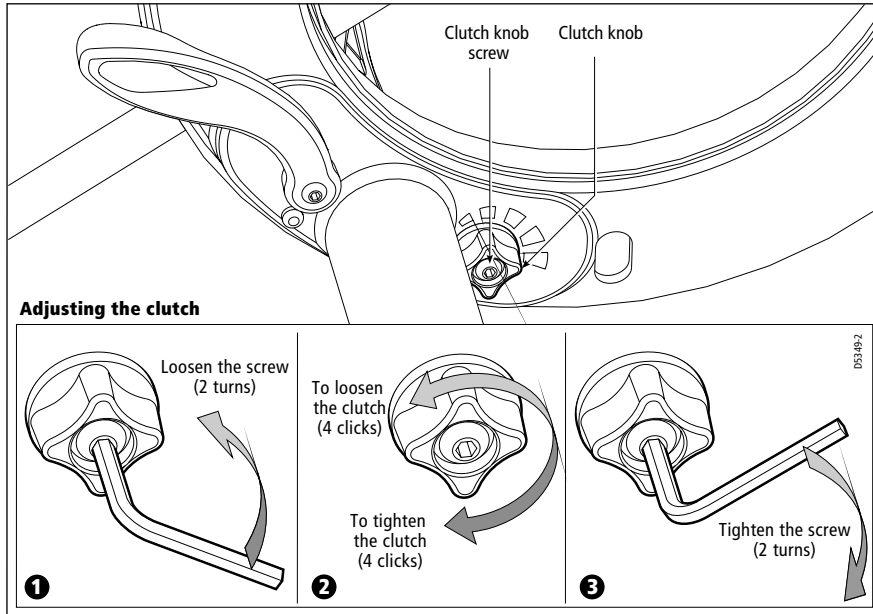

Replacing the belt

The drive belt is designed to be user serviceable. If there is insufficient adjustment to cure a slipping clutch, or if the drive belt is damaged in any way (if it is broken, frayed or stretched), you should replace the drive belt. You can obtain a replacement belt from any Raymarine dealer (part number A18083). Fitting instructions are supplied with the belt.

User serviceable parts

You can obtain the following 4000 mk2 wheel drive spare parts from your Raymarine dealer:

Part description	Part number
Front cover	A18074
Clutch lever	A18077
Clutch knob	A18078

Part description	Part number
Pedestal bracket (torque restraint)	A18080
Drive belt	A18083
Clutch kit (clutch eccentric and clutch roller)	A18084
Single spoke clamp, screws and inserts	A18089

Control unit

Routine checks

The control unit is a sealed unit. As a result, user maintenance is limited to the following routine checks:

- make sure all cable connectors are firmly attached
- examine the cables for signs of wear or damage – replace any damaged cables

Cleaning the display

CAUTION:

Take care when cleaning the display. Do not wipe the display screen with a dry cloth as this could scratch the screen coating. Do not use acid, ammonia based or abrasive products.

- **Never** use chemical or abrasive materials to clean the control unit. If the control unit is dirty, wipe it with a clean, damp cloth.
- In certain conditions, condensation may appear inside the display screen. This will not harm the unit, and you can clear it by switching on the illumination for a short time.

EMC advice

- When powered up, all electrical equipment produces electromagnetic fields. These can cause adjacent pieces of electrical equipment to interact with one another, with a consequent adverse effect on operation.
- To minimize these effects and enable you to get the best possible performance from your Raymarine equipment, guidelines are given in the installation instructions, to enable you to ensure



minimum interaction between different items of equipment, i.e. ensure optimum Electromagnetic Compatibility (EMC).

- Always report any EMC-related problems to your nearest Raymarine dealer. We use such information to improve our quality standards.
- In some installations, it may not be possible to prevent the equipment from being affected by external influences. In general this will not damage the equipment but it can lead to spurious resetting action, or momentarily may result in faulty operation.

4.3 Product support

Raymarine products are supported by a worldwide network of distributors and Authorized Service Representatives. If you encounter any difficulties with this product, please contact either your national distributor, service representative, or the **Raymarine Technical Services Call Center**. Refer to the back cover or the Worldwide Distributor List for contact details.

Software version

If you cannot trace or rectify the fault, contact your nearest Raymarine distributor or Service Representative, specifying:

- the product serial number, which is printed on the rear cover of the autopilot
- the software version number:
 - press **standby** for 4 seconds to display the software version

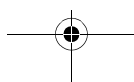
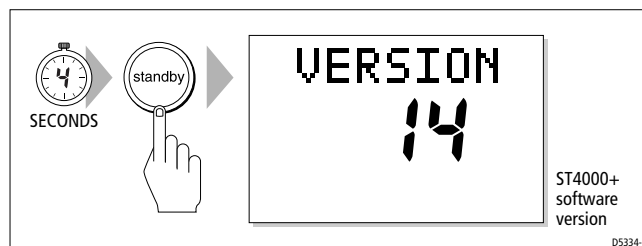

Chapter 5: Installing the ST4000+

5 Installing the ST4000+

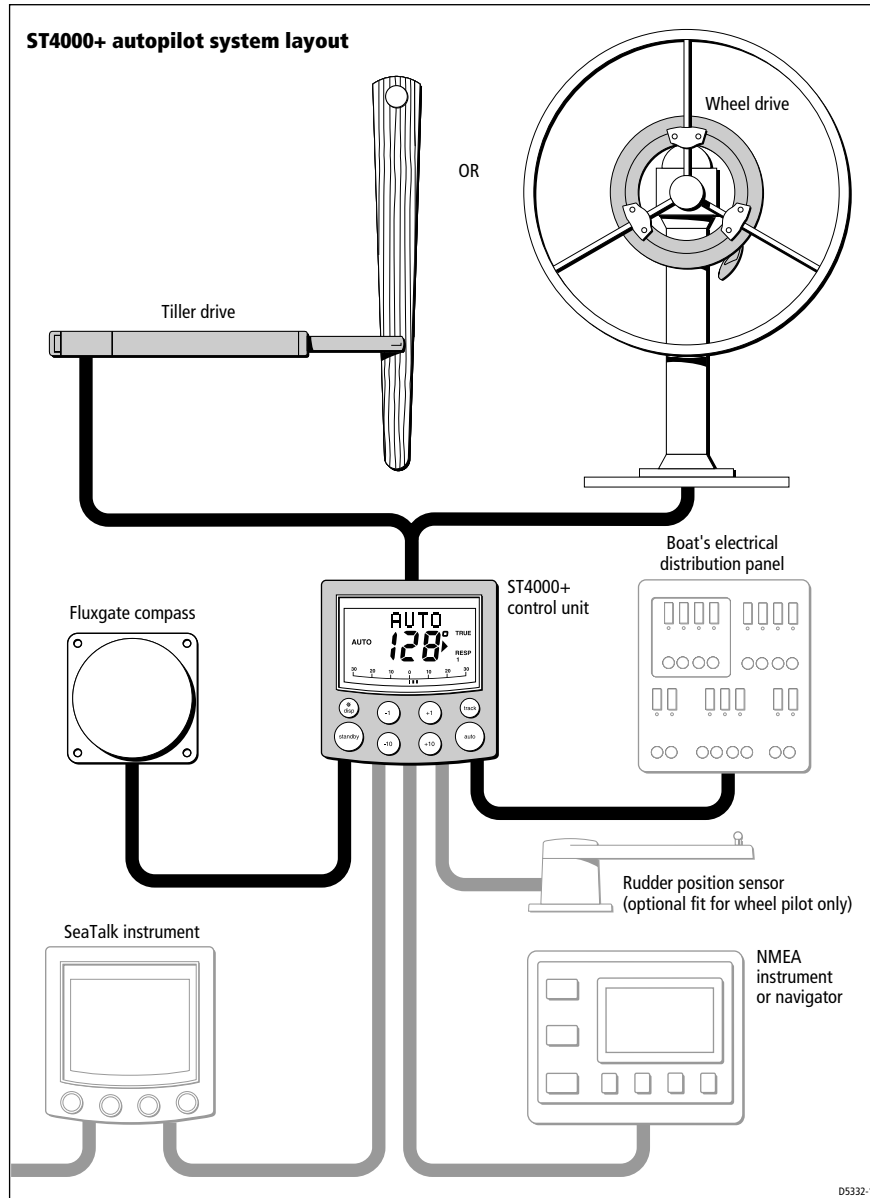



This chapter explain how to install and connect the components of your autopilot system:

5.1 Planning the installation

Before you start installing the autopilot system, read this chapter thoroughly, with particular regard to the EMC installation guidelines.

- consider how you will run cables to and from each component
- avoid running cables through bilges where possible
- avoid running cables close to fluorescent lights, engines, radio transmitting equipment etc.

Tools required and parts supplied

To install this autopilot system you will need the following items:

- tape measure (metric/imperial)
- pliers and cross-head/pozi-drive screwdriver
- drill and drill bits:
 - 5 mm ($\frac{5}{32}$ in) for surface mount control unit
 - 3 mm ($\frac{1}{8}$ in) for compass and rudder position sensor
- pencil, masking tape and center punch
- sandpaper/file to smooth cut edges
- for the control unit:
 - jigsaw or 90 mm hole cutter (for the control unit aperture)
 - SeaTalk cables (if required – see *page 42*)
 - extra power cable (if required - see *page 42*)
- for the tiller drive only:
 - two-part epoxy adhesive for tiller pin and mounting socket
 - installation accessories (if required – see *page 51*)
 - drill bits as required
 - appropriate power cable (see *page 58*) for the tiller socket
- for the wheel drive only:
 - spanner for the wheel nut
 - washing-up liquid (to lubricate the spokes)
 - hacksaw to cut the pedestal bracket
 - 4 mm + 6 mm drill bits and 3 mm allen key (supplied)

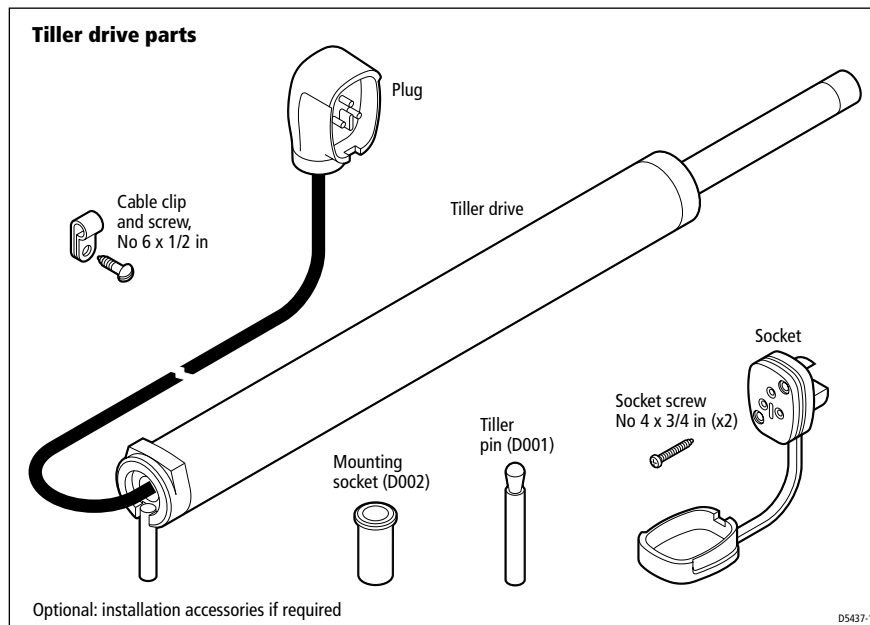
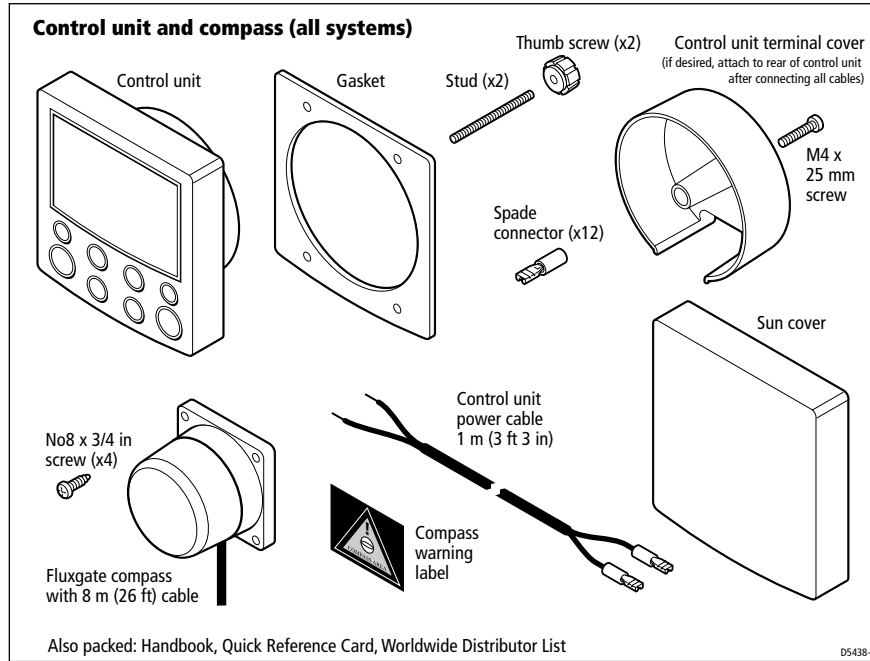

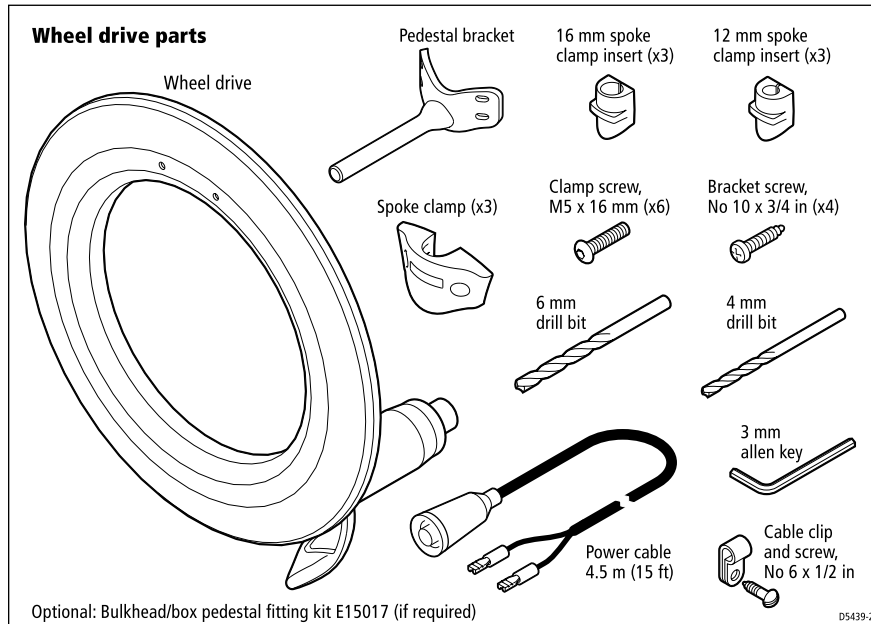

EMC installation guidelines

All Raymarine equipment and accessories are designed to the best industry standards for use in the recreational marine environment.

Their design and manufacture conforms to the appropriate Electromagnetic Compatibility (EMC) standards, but correct installation is required to ensure that performance is not compromised.

Although every effort has been taken to ensure that they will perform under all conditions, it is important to understand what factors could affect the operation of the product.

The guidelines given here describe the conditions for optimum EMC performance, but it is recognized that it may not be possible to meet all of these conditions in all situations. To ensure the best possible conditions for EMC performance within the constraints imposed by any location, always ensure the maximum separation possible between different items of electrical equipment.

For **optimum** EMC performance, it is recommended that **wherever possible**:

- Raymarine equipment and cables connected to it are:
 - At least 3 ft (1 m) from any equipment transmitting or cables carrying radio signals e.g. VHF radios, cables and antennas. In the case of SSB radios, the distance should be increased to 7 ft (2 m).
 - More than 7 ft (2 m) from the path of a radar beam. A radar beam can normally be assumed to spread 20 degrees above and below the radiating element.
- The equipment is supplied from a separate battery from that used for engine start. Voltage drops below 10 V, and starter motor transients, can cause the equipment to reset. This will not damage the equipment, but may cause the loss of some information and may change the operating mode.
- Raymarine specified cables are used. Cutting and rejoining these cables can compromise EMC performance and must be avoided unless doing so is detailed in the installation manual.
- If a suppression ferrite is attached to a cable, this ferrite should not be removed. If the ferrite needs to be removed during installation it must be reassembled in the same position.

EMC suppression ferrites

The following illustration shows typical cable suppression ferrites used with Raymarine equipment. Always use the ferrites supplied by Raymarine.

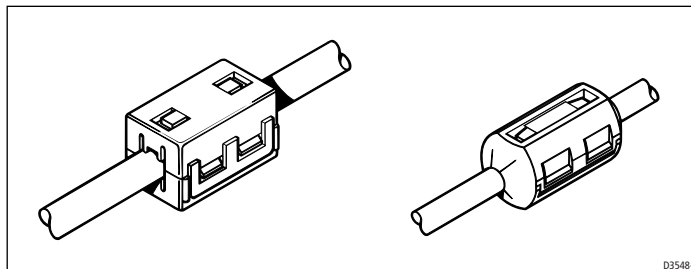

Connections to other equipment

If your Raymarine equipment is to be connected to other equipment using a cable not supplied by Raymarine, a suppression ferrite **MUST** always be attached to the cable near to the Raymarine unit.

5.2 Control unit

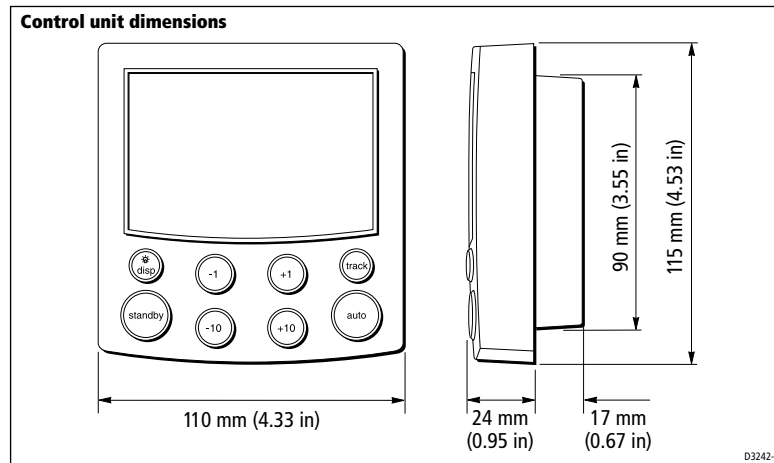

Location

Locate the ST4000+ control unit so it is:

- within easy reach from the steering position
- viewable straight on, or with a maximum viewing angle of 30°
- protected from physical damage
- at least 230 mm (9 in) from any compass
- at least 1 m (3 ft) from any radio/radar receivers/transmitters

The selected location should also:

- be clean, smooth and flat
- be accessible from behind (so you can secure and run cables)
- have sufficient space to accommodate the rear of the control unit and connectors
- allow at least 6 mm ($\frac{1}{4}$ in) between adjacent control units and instruments so you can fit their sun covers

CAUTION:

The ST4000+ front cover is waterproof when installed according to the following instructions. However, the rear cover must be protected from water in a ventilated and drained area. Any water or water vapor in this area could cause damage by coming into contact with electrical connections or condensation by entering the control unit through its breathing hole.

Mounting procedure

Control units are available in surface mount and flush mount styles.

Surface mount control units

To fit a surface mount control unit:

1. Apply the surface mount template (supplied at the back of this handbook) to the selected bulkhead.
2. Mark the centers of the two fixing holes and the cable boss.
3. Drill two 5 mm ($\frac{3}{16}$ in) diameter holes for the fixing studs.
4. Use a 90 mm (3.55 in) diameter cutter to drill the hole for the cable boss.
5. Peel the protective sheet from the self-adhesive gasket, then stick the gasket into position on the rear of the control unit surround.
6. Screw the fixing studs into the control unit.
7. Pass the cables (power, compass, SeaTalk etc.) through the bulkhead and connect them to the appropriate terminals (as described later in this chapter).
8. Assemble the control unit to the bulkhead.
9. Secure the control unit with the thumb nuts provided.
Hand-tighten the thumb nuts – do NOT use a wrench.

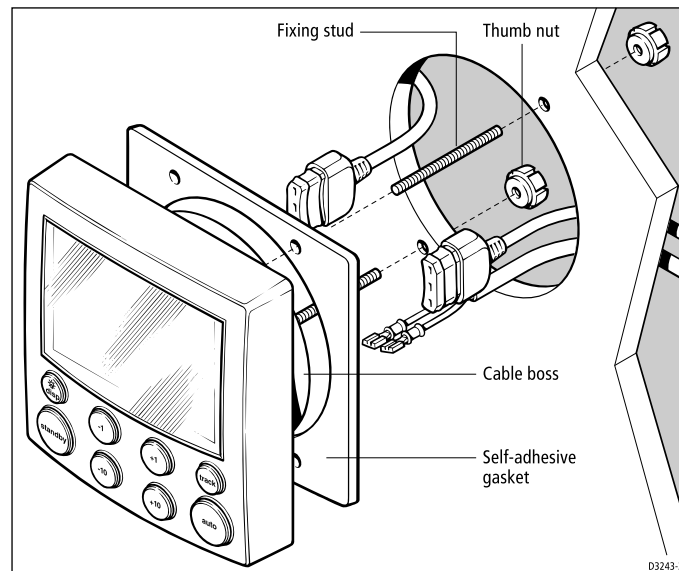

Flush mount control units

To fit a flush mount control unit:

1. Ensure that the intended mounting location is between 3 mm ($\frac{1}{8}$ in) and 20 mm ($\frac{3}{4}$ in) thick.
2. Apply the flush mount template (supplied at the back of this handbook) to the selected location. Mark the aperture into which the control unit will sit, then remove the template.
3. Use a jigsaw to cut out this aperture.
4. Peel the protective sheet from the self-adhesive gasket, then stick the gasket into position on the rear of the control unit surround.
5. Screw the two fixing studs into the threaded sockets on the rear of the control unit.
6. Pass the cables (power, compass, SeaTalk, etc.) through the bulkhead and connect them to the appropriate terminals (as described later in this chapter).
7. Place the assembled control unit, studs and gasket into the panel.
8. Locate the bracket onto the fixing studs and secure the assembly to the panel with the thumb-nuts. **Hand-tighten** the thumb nuts – do NOT use a wrench.

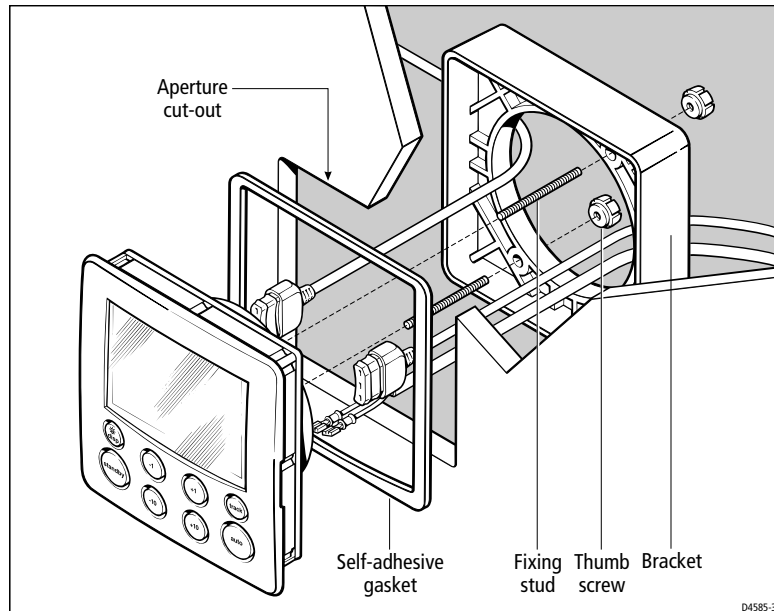

Cable connectors

With the exception of the SeaTalk cables, spade connectors are used to make all connections to the control unit.

When fitting the spade connectors, make sure the connector fits securely over the blade and not between the connector and its plastic insulating cover. Incorrect fitting will give intermittent contact which will lead to faulty autopilot operation.

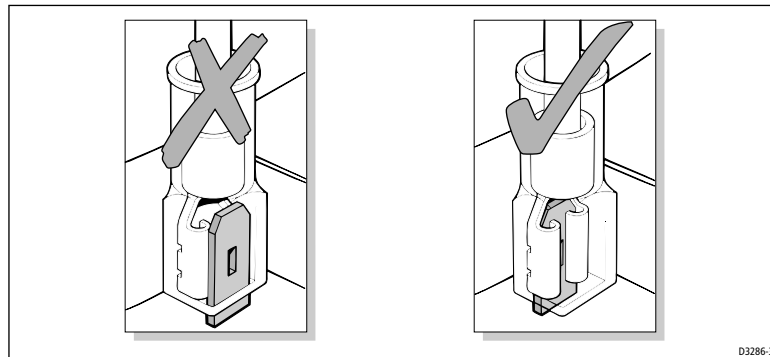

D3286-3

Power supply connection

- The autopilot requires its own dedicated power supply – it cannot source its power from SeaTalk. However, it can be used to supply power to other SeaTalk instruments.
- You must fit a 12 A fuse (or equivalent circuit breaker) to the +12 V supply.

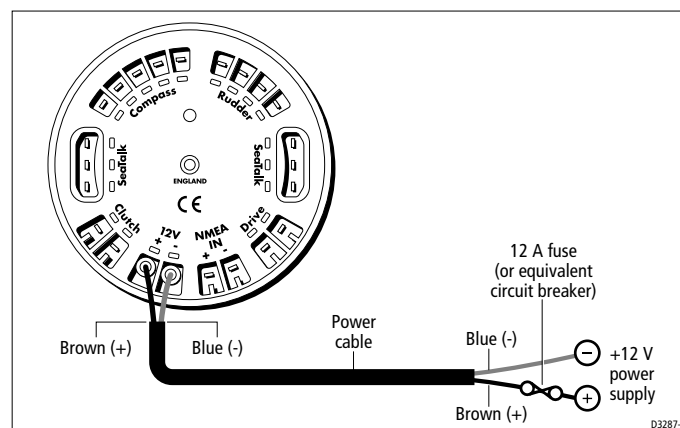

D3287-2

- As standard, we supply a 1 m (3 ft 3 in) power cable terminated with $\frac{1}{4}$ inch spade connectors.
- You can extend the power cable if required. The following table shows the minimum acceptable cable sizes:

Cable length	Copper area	AWG
Up to 2.5 m (8 ft)	1.0 mm ²	18
Up to 4.0 m (13 ft)	1.5 mm ²	16
Up to 6.0 m (19.5 ft)	2.5 mm ²	14

Note: If you need to extend the cable, you *MUST* use the correct cable size. A lighter gauge cable might cause a voltage drop between the supply and the control unit. This will reduce the power to the drive, causing slower response to course changes and corrections.

SeaTalk connections

You will not need any SeaTalk cables to install the standard ST4000+ autopilot system.

However, if you want to connect your ST4000+ control unit to other SeaTalk equipment, you will need to purchase the necessary cables from your Raymarine dealer.

The following illustration shows the range of available SeaTalk cables.

Flat moulded plugs at each end



Part no.	Type	Length
D284	Flat moulded plugs at each end	1 m (3 ft 3 in)
D285	Flat moulded plugs at each end	3 m (9 ft 10 in)
D286	Flat moulded plugs at each end	5 m (16 ft 5 in)
D287	Flat moulded plugs at each end	9 m (29 ft 6 in)
D288	Flat moulded plugs at each end	20 m (65 ft 6 in)

Flat moulded plug to round plug



Part no.	Type	Length
D187	Flat moulded plug to male round plug	0.15 m (6 in)
D188	Flat moulded plug to female round plug	0.15 m (2 in)

D5417-2

Typical SeaTalk connections

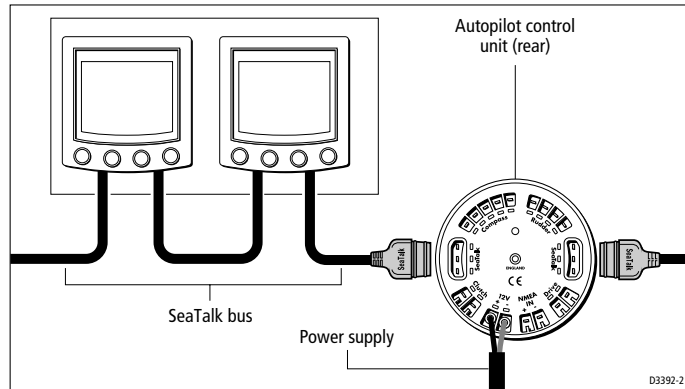

5 Installing the ST4000+

NMEA connections

ST4000+ can receive wind and navigation data in NMEA 0183 format for use in Track and Wind Vane modes.

Receiving NMEA data

NMEA cabling

Connect the NMEA navigator or wind instrument to the **NMEA IN** terminals on the rear of the ST4000+ control unit.

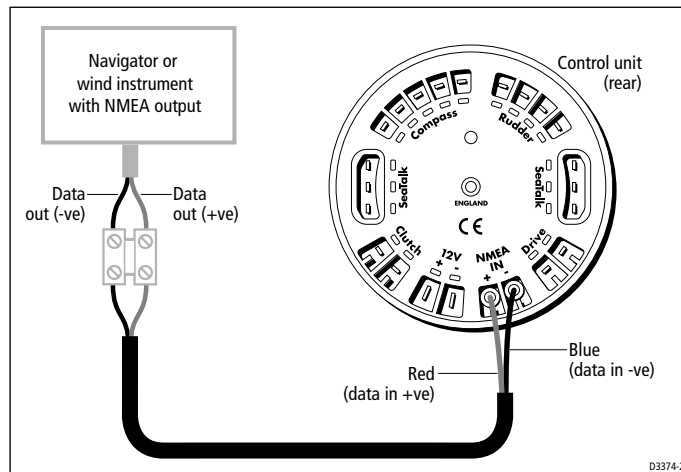

Note: *If you need to connect more than one item of NMEA equipment, you will need to connect one of them to the SeaTalk system using a SeaTalk/NMEA Interface (part number: E85001).*

NMEA data formats

The ST4000+ can decode the following NMEA 0183 navigation and wind data:

Information	NMEA 0183 data
Course Over Ground	VTG, RMC, RMA
Speed Over Ground	VTG, RMC, RMA
Cross Track Error	APB, APA, RMB, XTE
Bearing to Waypoint	APB, BWR, BWC, RMB
Distance to Waypoint	BWR, BWC, RMB
Waypoint Number	APB, APA, BWR, BWC, RMB
Apparent Wind Speed	VWR, MWV
Apparent Wind Angle	VWR, MWV
Speed Through Water	VHW
Depth	DBT
Water Temperature	MTW

Note: The autopilot only decodes the last four characters of waypoint names. This means that the last four characters of long waypoint names must be unique for the waypoint advance function to work.

Transmitting NMEA data

Transmitting NMEA data on SeaTalk

If the ST4000+ receives any of the NMEA data shown above, and the equivalent data is not present on SeaTalk, it will transmit the data onto SeaTalk to make it available to other SeaTalk instruments:

- the ST4000+ transmits depth information in the units defined by the first page in the data page rollover
- the ST4000+ always transmits water temperature in °C

Transmitting NMEA data to NMEA equipment

If you want to transmit information to NMEA equipment, you will need to connect a SeaTalk/NMEA Interface (part number: E85001) to the SeaTalk bus to convert SeaTalk data to NMEA data.

5.3 Fluxgate compass

Location

The compass contains a self-levelling mechanism. This enables the compass to provide accurate readings with pitch and roll movements up to $\pm 35^\circ$.

Note: *The rattle that the fluxgate compass makes when shaken is normal. It is caused by the pendulum weight hitting the inside of the case.*

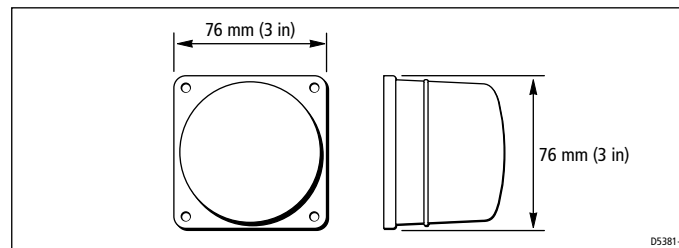

Fluxgate compass dimensions

Standard location

The compass is primarily designed for below deck, bulkhead mounting. On steel-hulled boats you must mount it above deck.

To achieve the best performance from the compass, mount it:

- as near as possible to the boat's pitch and roll center to minimize compass disturbance
- at least 0.8 m (2 ft 6 in) away from the boat's steering compass to prevent deviation of either compass
- away from the front third of the boat (otherwise shock motion will affect compass performance)
- away from potential sources of magnetic interference, such as: motors, drive units, loudspeakers, alternators/starters, electric cables, large ferrous objects (such as the engine, ballast, keel, gas bottles and tool boxes)

Note: *Because you align the compass after installation (see page 84), you can mount it so it faces in any direction.*



5 Installing the ST4000+

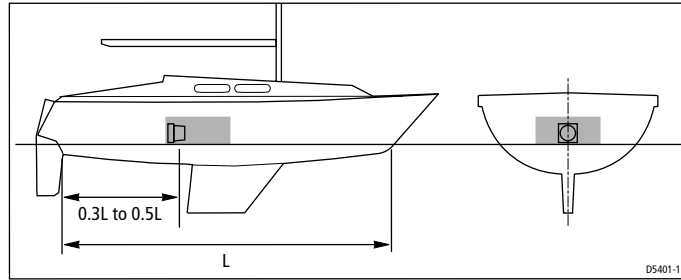

Compass - recommended location for non-steel hulls

Finding the most suitable location

To identify the best compass location on your boat, start at the pitch and roll center then move the compass up and/or aft until you find a location with minimal magnetic disturbance.

Note: To check if the intended mounting location is free from magnetic influence, tape a handheld compass to the chosen location, then turn the boat through 360°. The readings on the handheld compass and your boat's main steering compass (if accurately aligned) should not differ by more than 10° at any heading.

Steel-hulled boats

On steel-hulled boats you must mount the compass at least 1.2 m (4 ft) above the main deck or wheelhouse. Otherwise the compass will not work correctly because the hull will prevent it from sensing the Earth's magnetic field. The following illustration shows recommended mounting positions for steel-hulled boats.

Note: The higher above the waterline you mount the compass, the more the boat's pitch and roll will affect compass performance.

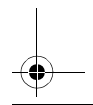
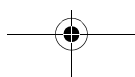
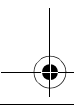
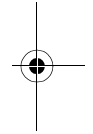
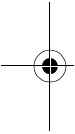

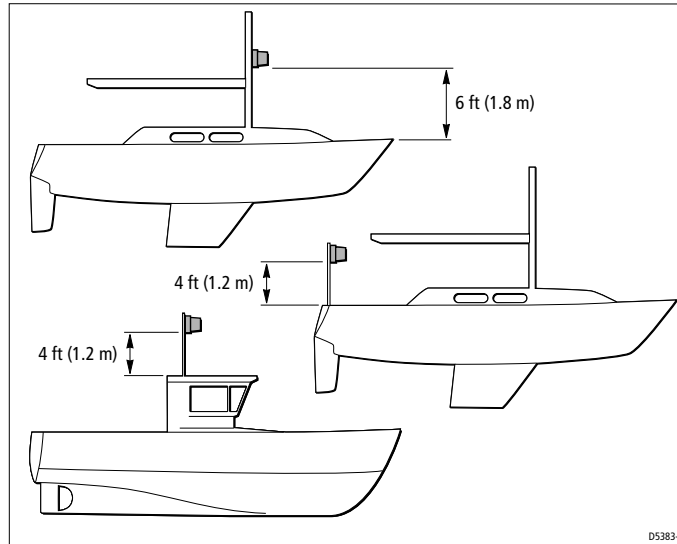

Compass - recommended location for steel-hulls

5 Installing the ST4000+

Mounting

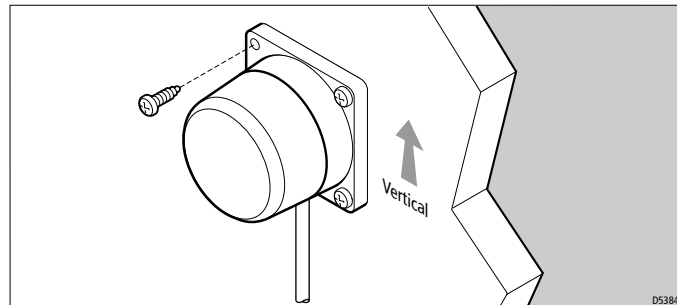

Fluxgate compass - orientation

CAUTION:

You must mount the fluxgate compass on a vertical bulkhead, with the cable exiting at the base.

1. Hold the compass against the mounting location.
2. Mark the four mounting holes, then remove the compass.
3. Drill four pilot holes using a 3 mm ($\frac{1}{8}$ in) drill bit.

4. Making sure the cable exits at the bottom of the compass, secure the fluxgate compass using the self-tapping screws provided (No 8 x $\frac{3}{4}$ in, pan-head).

Note: Stick the supplied warning label near to the compass, where it is clearly visible.

Connecting to the control unit

1. The compass is supplied with 8 m (26 ft) of cable. Route the cable to the control unit, taking into account the EMC installation guidelines (page 36).

Note: Make sure you leave some spare cable so, if necessary, you can re-position the compass to reduce deviation. If the standard cable is not long enough, your Raymarine dealer can supply a 10 m (30 ft) extension cable (part number: D174).

2. Connect the five cores of the cable as shown to the **Compass** terminals on the control unit.

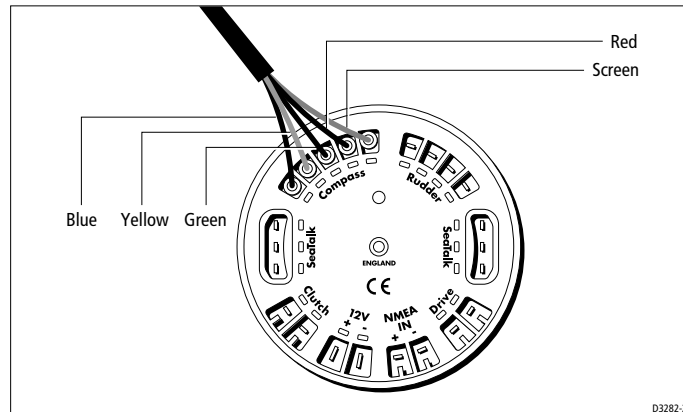

5.4 Tiller drive (tiller pilots only)

Critical dimensions

Installing the tiller drive involves mounting it between the tiller and a fixed point on the boat's structure. Two dimensions are critical for correct installation:

- **Dimension A = 620 mm (24.5 in):** the distance from the mounting socket to the tiller pin. Pull out the drive pushrod to this dimension.

Note: *If your installation requires a pushrod extension (see page 51) or cantilever mount (see page 55), this dimension will increase.*

- **Dimension B = 460 mm (18 in):** the distance from the rudder stock's center line to the tiller pin.

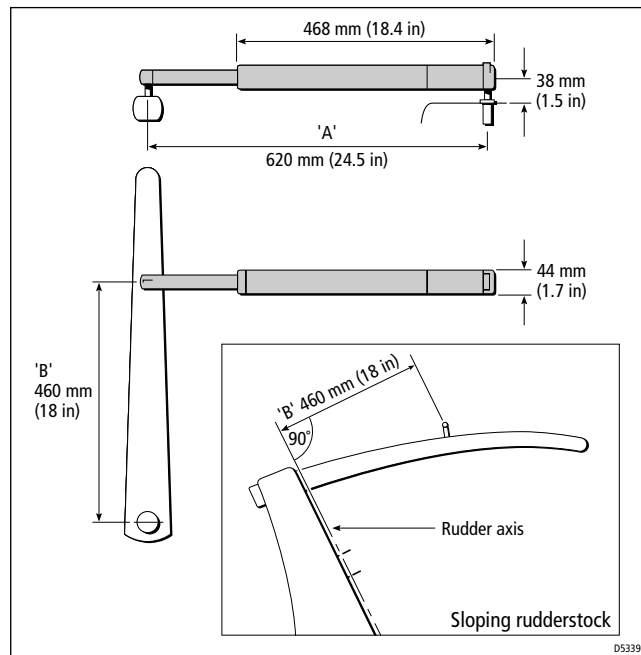

1. Clamp the tiller on the boat's center line and mark dimensions **A** and **B**. Use masking tape to locate the fixing points for the tiller pin and mounting socket.

Note: You can measure dimension **A** on either the port or starboard side of the cockpit, depending on which side you intend to mount the drive. If you select port mounting, you must correct the autopilot steering direction as described on page 76.

2. Make sure the measurements are at right angles (as shown on the diagram).
3. Make sure that the drive unit is mounted horizontally.

Basic installation

After establishing the control dimensions A and B, you can usually mount the tiller drive directly onto the cockpit seat.

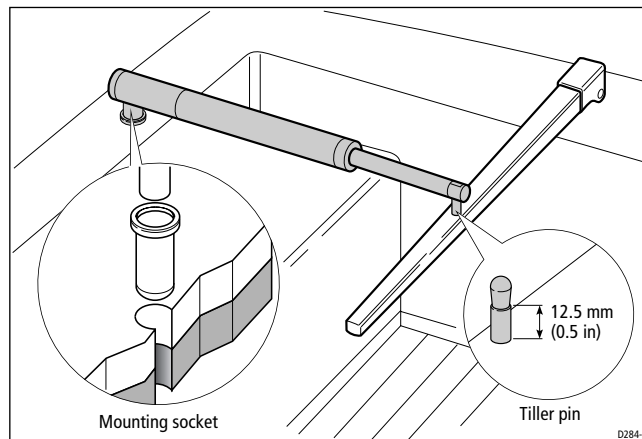

Installing the tiller pin (part no. D001)

1. Drill a 6 mm ($\frac{1}{4}$ in) diameter hole to a depth of 25 mm (1 in) at the fixing point you have marked on the tiller.
2. Use a two part epoxy adhesive (e.g. Araldite) to fix the tiller pin in place.
3. Position the shoulder of the pin so it is 12.5 mm ($\frac{1}{2}$ in) above the tiller surface.



Installing the mounting socket (part no. D002)

1. Drill a 12.5 mm ($1/2$ in) diameter hole to a depth of 25 mm (1 in) at the fixing point you have marked on the cockpit seat.
2. If the structure at the mounting position is less than 25 mm (1 in) thick, reinforce the underside with plywood bonded into position.
3. Install the mounting socket using a two part epoxy adhesive.

CAUTION:

As the tiller pilot is capable of generating high pushrod loads, you **MUST**:

- drill holes to the specified size and reinforce where necessary
- allow the epoxy to harden completely before apply a load

5 Installing the ST4000+

Installation accessories

If you are not able to install the drive unit directly onto the cockpit seat or tiller as described, use one (or a combination) of the following accessories:

- pushrod extensions
- tiller brackets
- cantilever sockets
- pedestal sockets

Pushrod extensions

If you need to increase the pushrod length (because of the distance from the mounting socket location to the center line), use a Raymarine pushrod extension.

Identifying the correct pushrod extension

1. Clamp the tiller on the boat's center line.
2. Measure dimension C.
3. Select the appropriate pushrod extension length (and part number) using the following table.

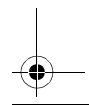
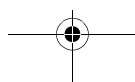
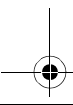
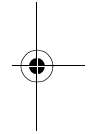
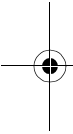

Dimension C	Pushrod extension length L	Part no.
620 mm (24.5 in)	Standard dimension	-
648 mm (25.5 in)	25 mm (1 in)	D003
673 mm (26.5 in)	51 mm (2 in)	D004
699 mm (27.5 in)	76 mm (3 in)	D005
724 mm (28.5 in)	102 mm (4 in)	D006
749 mm (29.5 in)	107 mm (5 in)	D007
775 mm (30.5 in)	152 mm (6 in)	D008

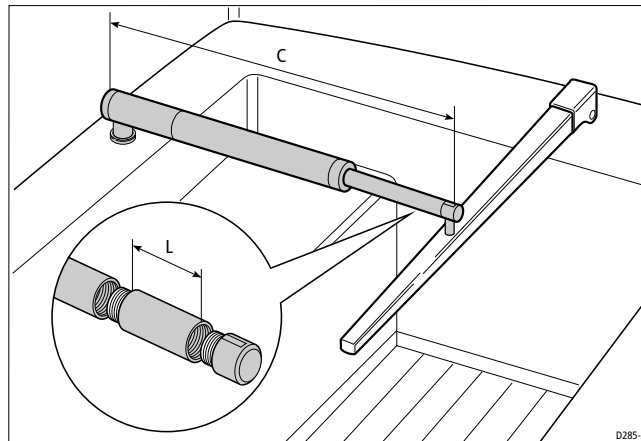

Mounting the pushrod extension

To mount the pushrod extension:

1. Unscrew the end of the tiller drive's pushrod.
2. Screw the extension into the pushrod.
3. Screw the pushrod end into the pushrod extension.

Tiller brackets

If the tiller is higher or lower than the mounting socket, you can use a Raymarine tiller bracket to vary the tiller pin offset so the drive is horizontal.

Identifying the correct tiller bracket

1. Clamp the tiller on the boat's center line.
2. Measure dimension D (if the pushrod is above the tiller) or dimension E (if the pushrod is below the tiller).
3. Select the appropriate bracket from the following table:

Dimension D (pushrod below tiller)	Dimension E (pushrod above tiller)	Bracket part no.
25 mm (1 in)	51 mm (2 in)	D009
51 mm (2 in)	76 mm (3 in)	D010
76 mm (3 in)	102 mm (4 in)	D011
102 mm (4 in)	127 mm (5 in)	D159
127 mm (5 in)	152 mm (6 in)	D160

Mounting the tiller bracket

1. Position the tiller bracket on the center line of the tiller (above or below) and establish the critical dimensions **A** and **B**

Note: To measure dimension **B** on a boat with a sloping rudderstock, refer to the diagram on page 55.

2. Mark the centers of the two bracket mounting holes.
3. Drill two 6 mm ($\frac{1}{4}$ in) diameter holes through the center line of the tiller at the positions you have marked.
4. Attach the tiller bracket using two 6 mm ($\frac{1}{4}$ in) diameter bolts, nuts and washers.
5. Bond the fixing bolts in place with two part epoxy adhesive
6. When the epoxy is completely hardened, fully tighten the nuts.
7. Attach the tiller pin to the bracket.



5 Installing the ST4000+

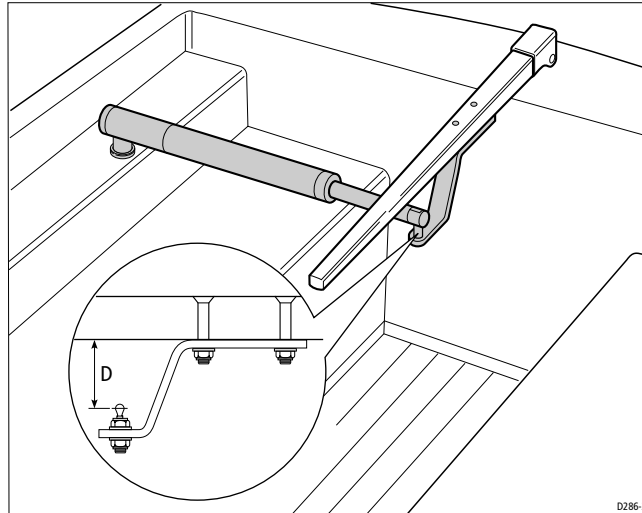

D286-2

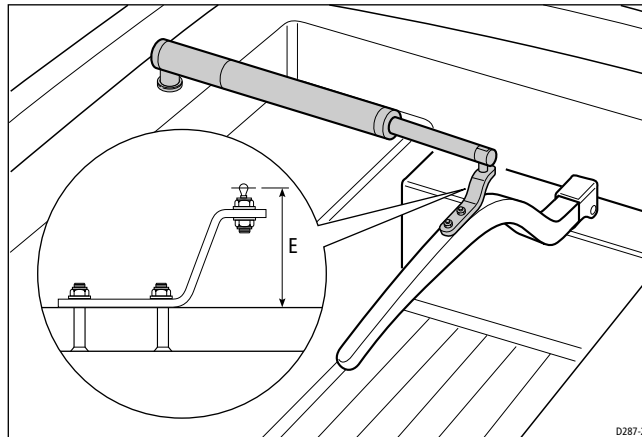

D287-2

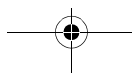

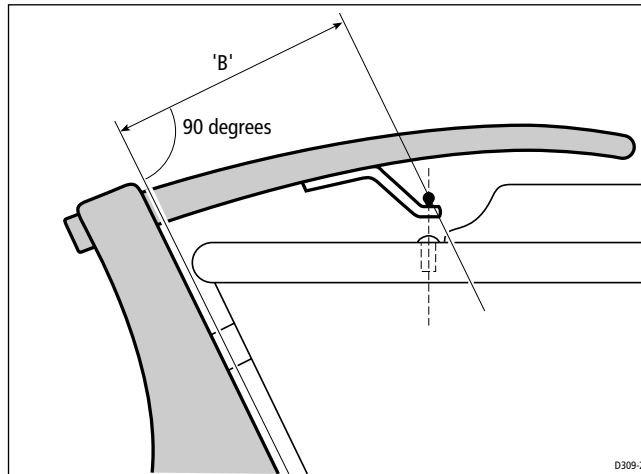

5 Installing the ST4000+

Cantilever mounting

If you need to attach the tiller drive to a vertical face (such as the cockpit sidewall), use a Raymarine cantilever socket assembly (part number D031):

- the maximum possible extension offset is 254 mm (10 in)
- you cut the cantilever to the exact length during mounting

Cutting the cantilever rod to length

1. Clamp the tiller on the boat's center line.
2. Measure dimension **F** (actual).
3. Refer to the table to establish a cutting length for the cantilever rod – **double check measurements before cutting**.
4. **Measure the rod from threaded end**, then cut the cantilever rod to length **L** using a hacksaw. Remove any sharp edges with a file.

Dimension F	Cut length L
686 mm (27 in)	51 mm (2 in)
711 mm (28 in)	75 mm (3 in)
737 mm (29 in)	102 mm (4 in)
762 mm (30 in)	127 mm (5 in)
787 mm (31 in)	152 mm (6 in)
813 mm (32 in)	178 mm (7 in)
838 mm (33 in)	203 mm (8 in)

5 Installing the ST4000+

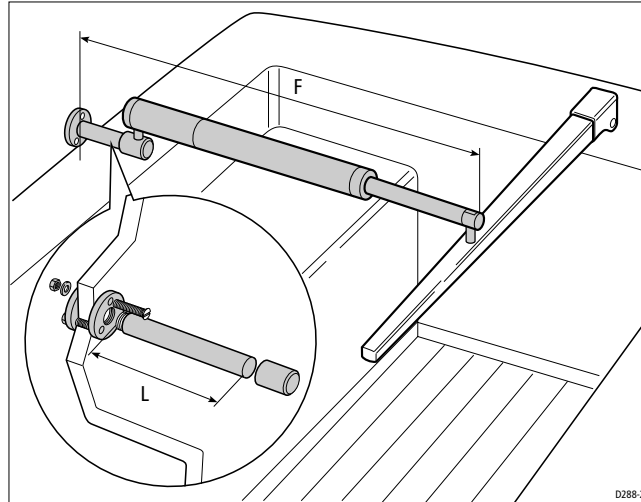
**Mounting the cantilever assembly**

To mount the cantilever assembly:

1. Temporarily assemble the cantilever by screwing the rod into the mounting ring.
2. Ensure the drive unit is horizontal and then mark the location of the mounting ring and its mounting holes.
3. Drill three 6 mm ($\frac{1}{4}$ in) diameter holes at the positions you have marked.
4. Bed the mounting ring on a thin coat of silicon sealant.
5. Use three 6 mm ($\frac{1}{4}$ in) diameter bolts, nuts and washers to attach the mounting ring to the backing plate (with the backing plate on the other side of the mounting surface, as shown above).
6. Screw the rod firmly into place.
7. Roughen the end of the cantilever rod and the inside of the cap to provide a key. Then apply two part epoxy adhesive to the rod end and the cap.
8. Place the cap over the rod end, **making sure the hole for the drive unit mounting pin faces upwards**. Allow the epoxy adhesive to harden fully before applying a load.

Note: When the autopilot is not in use, you can unscrew the complete rod assembly to leave the cockpit unobstructed.

Pedestal socket mounting

If you need to raise the height of the drive unit mounting socket to keep the tiller drive horizontal, use a Raymarine pedestal socket assembly.

Identifying the correct pedestal socket

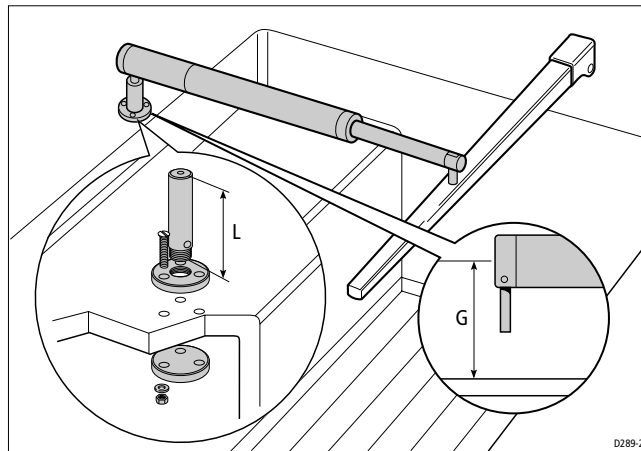

1. Clamp the tiller on the boat's center line.
2. Establish the standard control dimensions **A** and **B**.
3. With the tiller drive horizontal, measure dimension **G**.
4. Select the appropriate pedestal socket assembly from the table.

Dimension G	Pedestal socket length L	Part no.
38 mm (1.5 in)	Standard dimension	-
76 mm (3.0 in)	38 mm (1.5 in)	D026
89 mm (3.5 in)	50 mm (2.0 in)	D027
102 mm (4.0 in)	64 mm (2.5 in)	D028
114 mm (4.5 in)	76 mm (3.0 in)	D029
127 mm (5.0 in)	89 mm (3.5 in)	D030

Mounting the pedestal socket

1. Mark the mounting ring's position on the cockpit seat or counter.
2. Ensure that control dimensions **A** and **B** are correct.
3. Mark the bolt holes on the mounting ring and then drill three 6 mm ($\frac{1}{4}$ in) diameter holes.



4. Bed the mounting ring on a thin coat of silicon sealant.
5. Use three 6 mm ($\frac{1}{4}$ in) diameter bolts, nuts and washers to attach the mounting ring to the backing plate (with the backing plate on the other side of the mounting surface, as shown above).
6. Screw the mounting socket firmly into place.

Note: When the autopilot is not in use, you can unscrew the complete rod assembly to leave the cockpit unobstructed.

Tiller pins

Your Raymarine dealer can also supply the following lengths of tiller pin for other non-standard installations.

Description	Size	Part no.
Small threaded tiller pin	25 mm (1.0 in)	D014
Extra length tiller pin	72 mm (2.8 in)	D020
Extra length threaded tiller pin	72 mm (2.8 in)	D021

Connecting to the control unit

- Connect the tiller drive to the control unit via the waterproof plug and socket (supplied).
- The plug comes ready assembled to the tiller drive.
- Mount the socket in the cockpit next to the tiller drive.

Cabling

1. Measure the total length of cable run from the control unit to the socket location.
Use this table to identify the appropriate power cable size:

Cable length	Copper area	AWG
Up to 2.5 m (8 ft)	1.0 mm ²	18
Up to 4.0 m (13 ft)	1.5 mm ²	16
Up to 6.0 m (22 ft)	2.5 mm ²	14

2. Route the cable from the control unit to the socket location.
3. Use a suitable tool to crimp the spade receptacles (supplied) to the two cores.
4. Connect them as shown to the **Drive** terminals on the control unit.

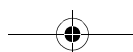

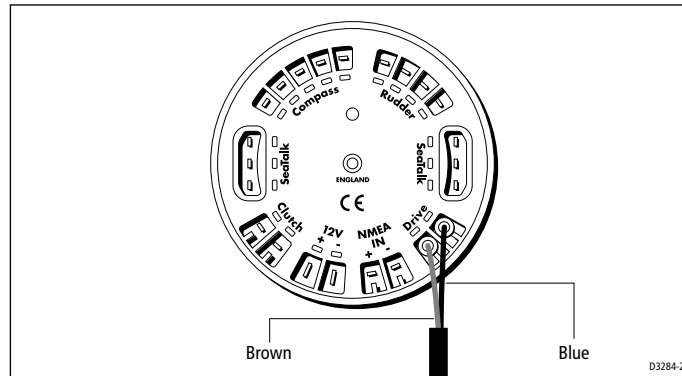

5 Installing the ST4000+

Installing the socket

1. Apply the template (supplied at the rear of this handbook) to the bulkhead.
2. Carefully drill a 18 mm ($23/32$ in) clearance hole and two 2.5 mm ($3/32$ in) pilot holes. Remove the template.
3. Pass the cable through the bulkhead and attach to the socket, making sure you connect each core to the correct pin (as shown).

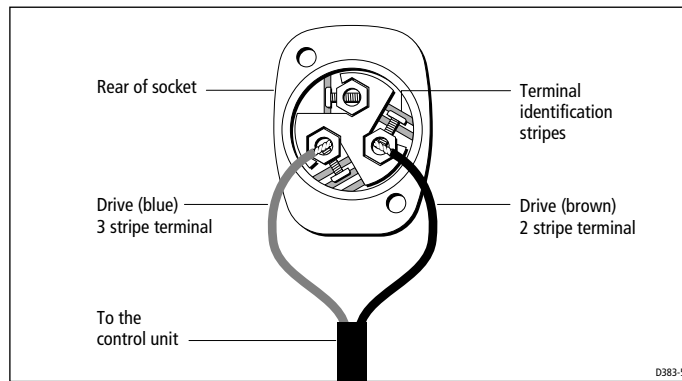

4. Attach the socket to the bulkhead using the two self-tapping screws. Use cable clamps to secure the drive cable at regular intervals.

5.5 Wheel drive (wheel pilots only)

The Raymarine wheel drive will fit 3, 4, 5, 6, 7 or 8 spoke wheels. It is designed to operate with steering systems with between 1 to 3.5 turns lock to lock.

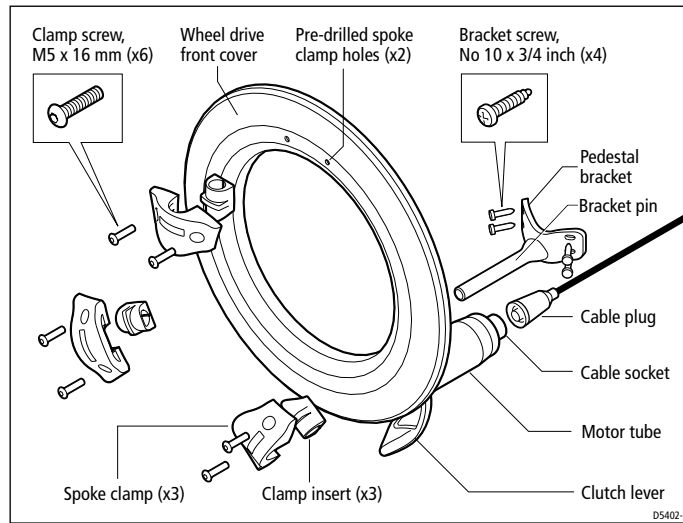

Wheel drive – main parts (see *page 102* for dimensions)

Installation stages

Installing the wheel drive involves four stages:

1. Drilling the spoke clamp holes in the front cover.
2. Securing the wheel drive to the wheel.
3. Attaching the pedestal bracket.
4. Connecting the drive to the control unit.

Drilling the spoke clamp holes

- Remove the wheel drive front cover:
 - the front cover is held onto the wheel drive by three 'push-fit' posts which sit in three sockets on the drive ring
 - to remove the cover, hold the motor in one hand and use your other hand to pull the cover up and away from the drive unit (as shown below)

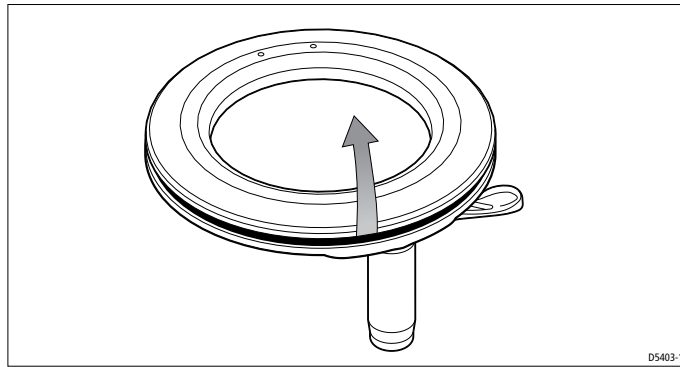

- Identify the appropriate spoke clamp holes for your wheel. With the arrow at the top, refer to the following diagrams:
 - the holes are numbered inside the cover (e.g. if you have a 5 spoke wheel, you need to drill the 4 locations marked with '5')
 - mark the appropriate spoke clamp holes and check them by holding the cover against your wheel

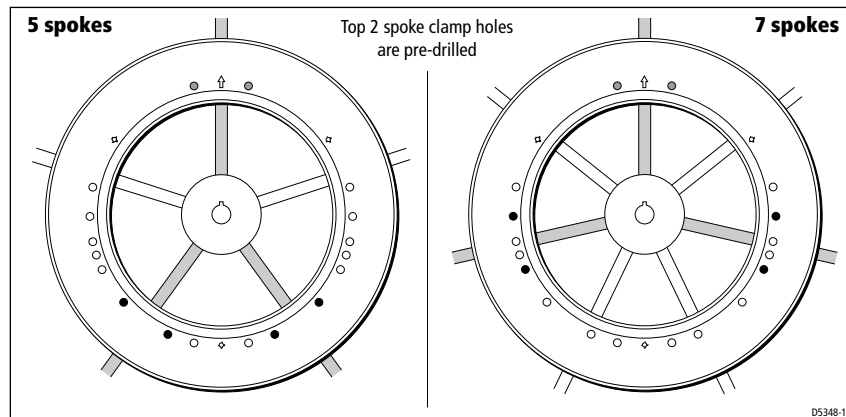

5 Installing the ST4000+

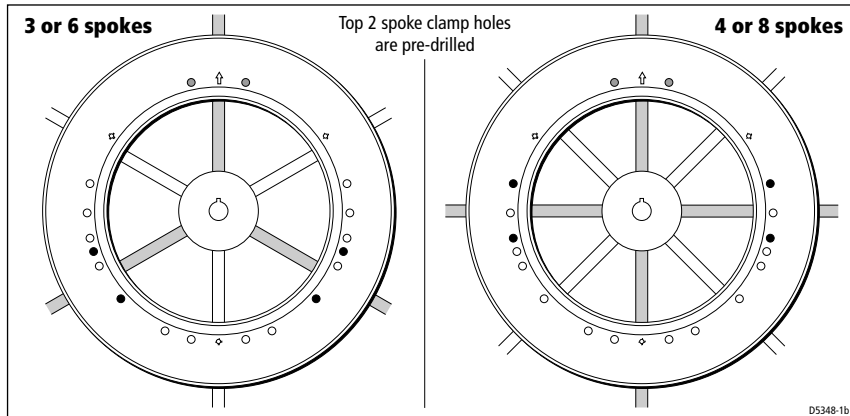

Note: The wheel drive is designed to work with 3 spoke clamps on 4 or 8 spoke wheels. For cosmetic reasons, however, you may want to fit an extra spoke clamp to the fourth spoke. Raymarine dealers can supply an extra spoke clamp (part number A18089).

3. Drill the appropriate spoke clamp holes using the larger of the supplied drill bits (6.0 mm or $\frac{1}{4}$ in):
 - drill from the inside, placing a piece of scrap wood under the cover to produce a clean exit hole
 - you will need to drill 4 new holes so the cover has 6 holes in total (2 for each spoke clamp)

Note: The spoke clamps will cover these exit holes, so they will not be visible when the wheel drive is installed.

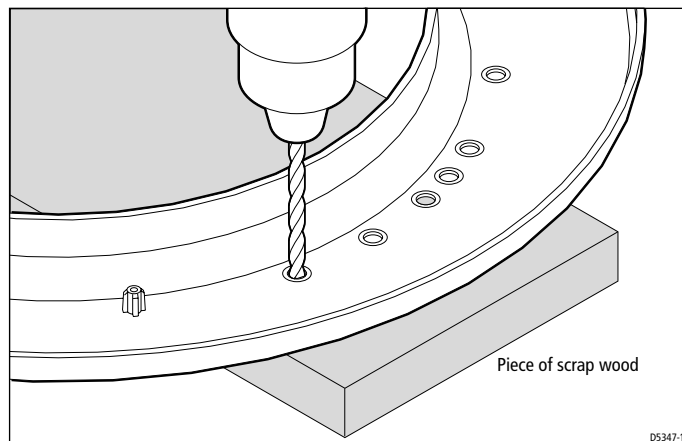

4. Align the cover with the wheel drive:

- the two pre-drilled holes (marked with an arrow) must line up with their matching pair of threaded inserts on the drive ring (also marked with an arrow)
- make sure that the other spoke clamp holes align with their threaded inserts

Note: *The cover will only fit back onto the wheel drive when you have aligned the two parts correctly.*

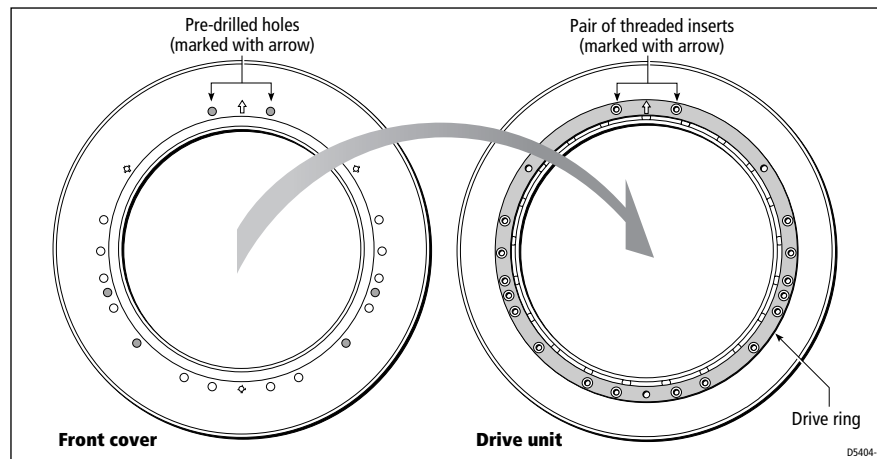

5. Fit the cover back onto the wheel drive:

- press the cover in the three places shown on the diagram below to push each of the posts back into its locating socket

Note: *This step is easier with the clutch engaged.*

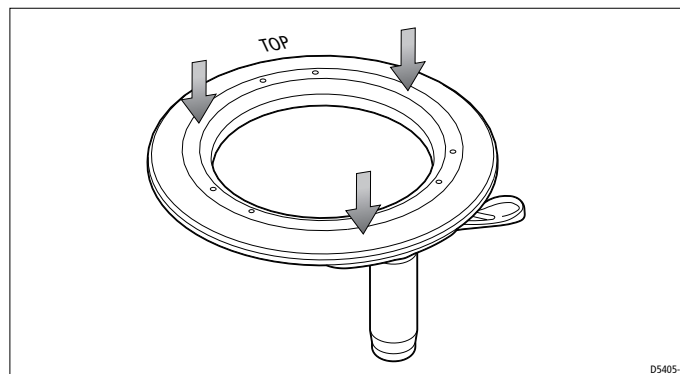

Securing the wheel drive to the wheel

1. Remove the wheel from the pedestal and place it on top of the drive unit, with the front of the wheel and drive both facing up.
2. Using the wheel drive template at the end of this book, select the correct set of spoke clamp inserts for your wheel:
 - measure the spoke diameter at a distance of about 135 mm (5.3 in) from the center of the wheel
 - select the appropriate set of inserts: the wheel drive is supplied with 2 sets of 3 inserts suitable for 12 mm ($\frac{1}{2}$ in) and 16 mm ($\frac{5}{8}$ in) diameter spokes – each insert is marked with its size
3. Fit the first spoke clamp:
 - lubricate the spoke with washing-up liquid – so you can slide the spoke clamp along the spoke to adjust its position
 - place the insert on the spoke about 135 mm (5.3 in) from the wheel center – this distance is not critical as the wheel drive will self-center as you fit all 3 spoke clamps
 - place the spoke clamp onto the insert, making sure that you have correctly located the clamp insert in the clamp
 - locate 2 of the clamp screws (M5 x 16 mm allen-head screws)
 - **lightly** tighten the screws using the 3 mm allen key (supplied)

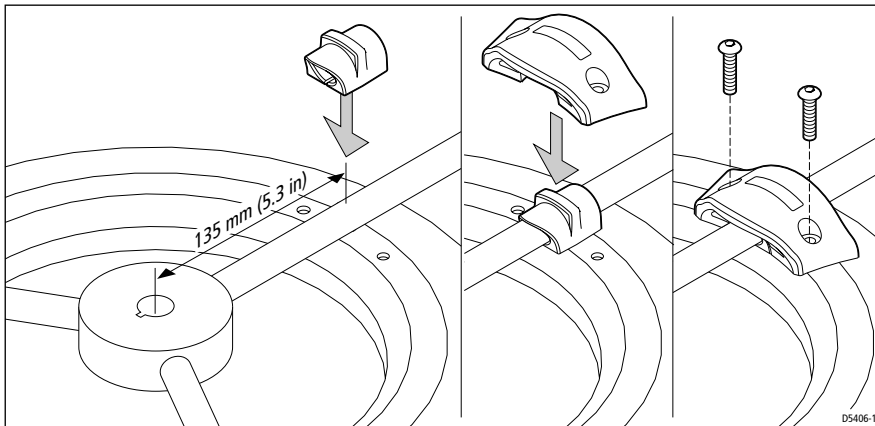

4. Repeat step 3 to fit the other 2 spoke clamps. As you fit each one, adjust the position of the wheel relative to the wheel drive so the holes in the clamp line up with the holes in the cover. **As you do this, the wheel drive will self-center on the wheel.**
5. After fitting all 3 spoke clamps, **fully tighten** the screws.

Attaching the pedestal bracket

Note: If your wheel is bulkhead or box pedestal mounted, you will need to obtain a bulkhead fitting kit (part number E15017) from your Raymarine dealer. Fitting instructions are supplied with the kit.

Motor tube location

Depending on the design of your pedestal and any surrounding obstructions, you can mount the wheel drive in one of two ways:

- **Slot 1 installation:** the standard position uses slot 1 on the back of the wheel drive (the slot closest to the motor tube) so the motor tube is at the bottom to the right of the pedestal
- **Slot 2 installation:** the alternative installation uses slot 2 to position the motor tube at the top to the left of the pedestal

Select the appropriate slot so the motor tube is clear of obstructions.

CAUTION:

If you use slot 2 and you have a pedestal-mounted compass, the drive motor may affect compass readings.

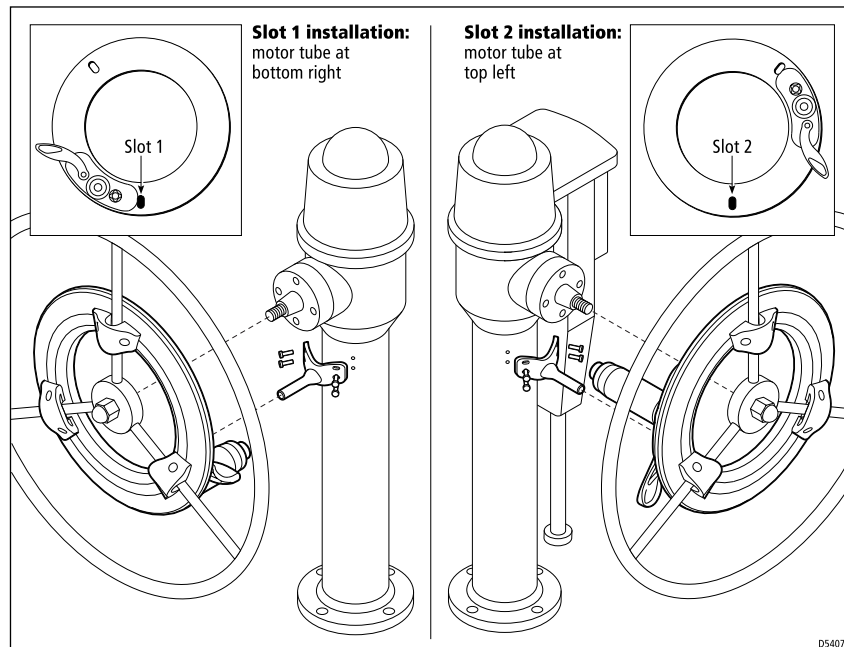

Pedestal bracket – length and position

Note: If you are replacing an existing 4000 wheel drive, you need to: remove the old pedestal bracket, cut the new bracket pin to the correct length (see steps 2 and 3 below), then secure it in the standard orientation using the existing pedestal holes.

- Fit the wheel onto the pedestal, tighten the wheel nut to hold the wheel in place, and engage the wheel drive's clutch:
 - if possible, lock the wheel in position with the appropriate slot centered at the bottom of the wheel
 - otherwise, you will find it useful to have an assistant to hold the wheel in position so you can locate the bracket correctly
- Measure dimension A – the distance between the front of the pedestal and the rear edge of the drive's front cover (see diagram):
 - you may find it easiest to hold the bracket below the wheel drive and mark dimension A directly on the pin

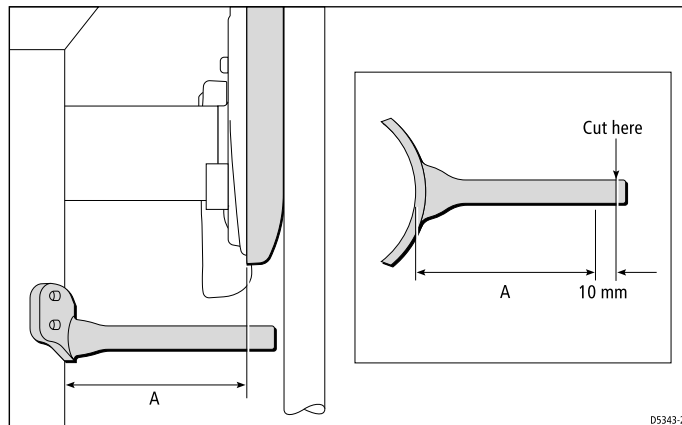

Note: If the wheel is bent or not running true, dimension A will change with the wheel position. Measure the **smallest** distance.

- Use a hacksaw to cut the pin **10 mm (0.4 in) LONGER** than dimension A. Remove any sharp edges at the cut end with sandpaper or a file.
- Place the pin end in slot 1 or 2 (as required):
 - to do this you may need to loosen the wheel nut so you can slide the wheel forward slightly, place the pin end in the slot, return the wheel to its normal position and re-tighten the wheel nut

Note: You can install the pedestal bracket either way up. In the standard orientation the pin is at the bottom (below the mounting holes – see diagram). If obstructions on the pedestal prevent you from using the standard orientation, you can install the bracket so the pin is at the top (above the mounting holes).

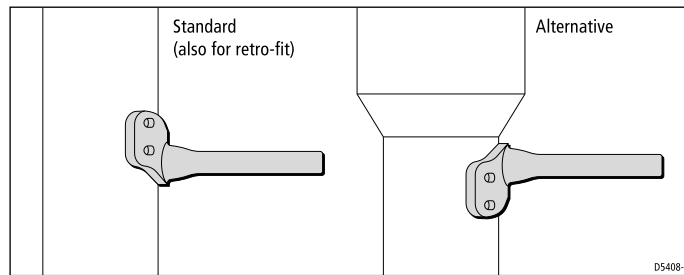

5. Making sure the slot is central at the bottom of the drive unit (6 o'clock position) and the pin is in the **middle** of the slot, carefully draw around the bracket.

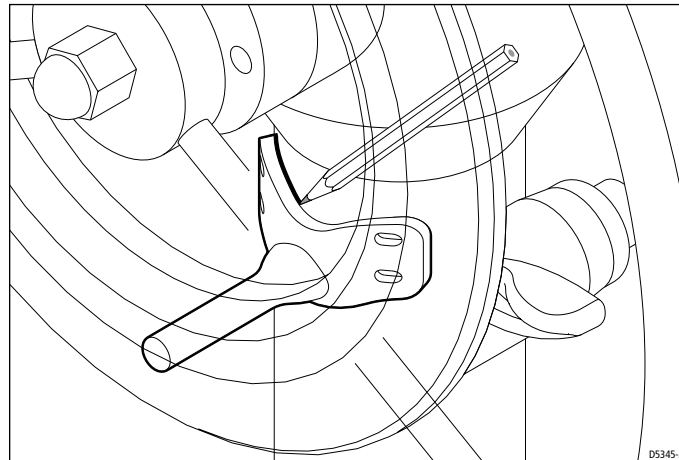

6. Remove the wheel, then hold the bracket on the pedestal in the location you have marked.
7. Check the position and alignment of the pedestal bracket:
 - the bracket pin should be 154 mm (6.1 in) below the pedestal spindle (see the following diagram)
 - the bracket pin should be aligned so it is directly below the pedestal spindle (see the following diagram)

5 Installing the ST4000+

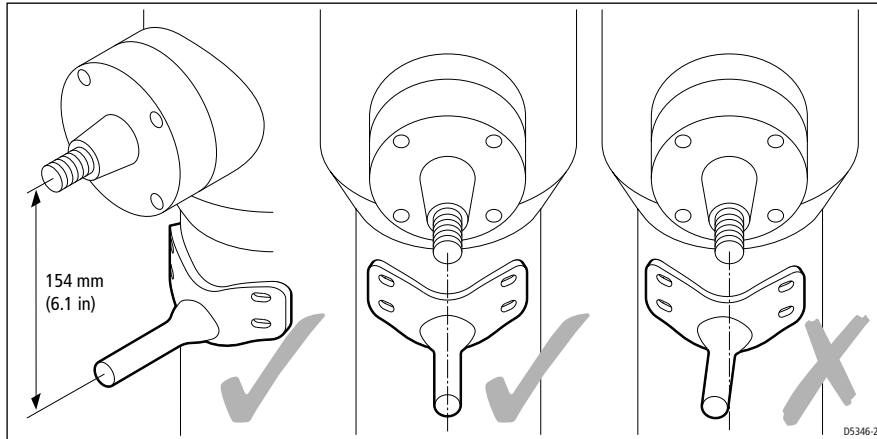

8. When the pedestal bracket is correctly positioned and aligned, mark around the inside of the slots, then remove the bracket.
9. Use a center-punch to mark the center of each slot, then use the smaller supplied drill bit to drill a 4.0 mm ($\frac{5}{32}$ in) diameter hole.

Note: Drill at right angles to the pedestal surface.

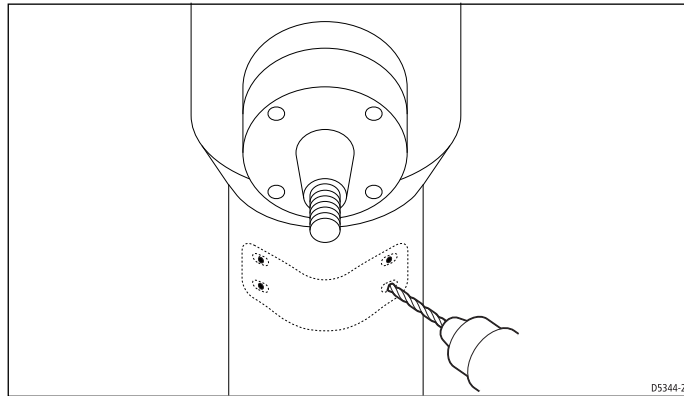

10. Hold the bracket in place then **lightly** tighten the four cross-head screws (No 10 x $\frac{3}{4}$ in). As you do this, make sure the bracket is correctly aligned.
11. Replace the wheel, making sure that you locate the pin in the correct slot (slot 1 or slot 2).
12. Turn the wheel with the clutch off to check that the bracket is correctly positioned and aligned.

Note: *If the wheel is bent or the wheel drive is off center, the pin will move up and down in the back plate slot. As long as the pin does not hit the top or bottom of the slot, this pin movement will not affect the drive unit's performance.*

13. When you have checked alignment, **fully** tighten all four screws.

Connecting to the control unit

When you have attached the pedestal bracket, you need to connect the wheel drive to the control unit. The drive unit is supplied with 4.5 m (15 ft) of 2-core cable with a waterproof socket at one end.

1. Connect the socket to the plug on the wheel drive's motor tube:
 - remove the socket cover
 - pull back the plug cover
 - align the locking ring, plug and socket as shown below

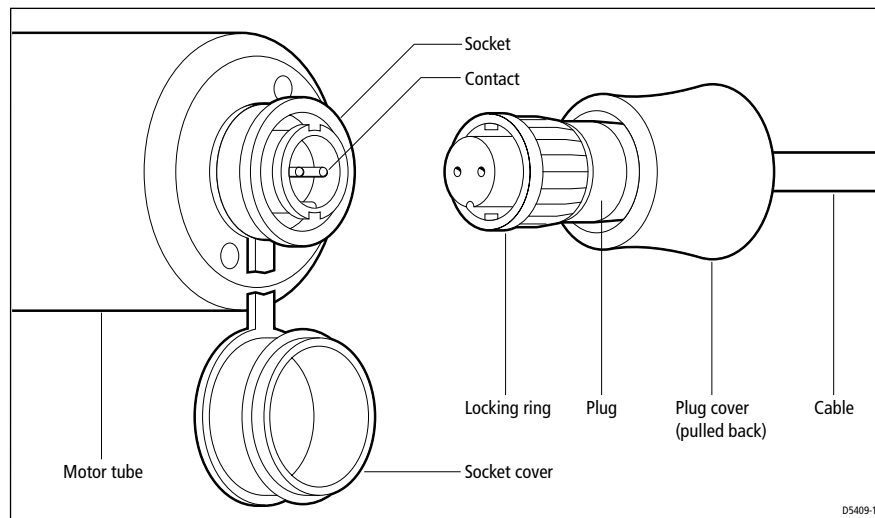

- push the plug firmly into the socket
- turn the locking ring 90° clockwise
- make the connection waterproof by pulling the plug cover across so it protects the plug and socket

Note: *To remove the plug, pull back the cover and turn the locking ring 90° anti-clockwise. If you disconnect the socket for any reason, always use the attached rubber cover to protect the socket.*

5 Installing the ST4000+

2. Route the cable through the pedestal (or guard rail) and back to the control unit:
 - if the pedestal has a cable duct, use this for the drive cable to make sure that it cannot foul the steering mechanism

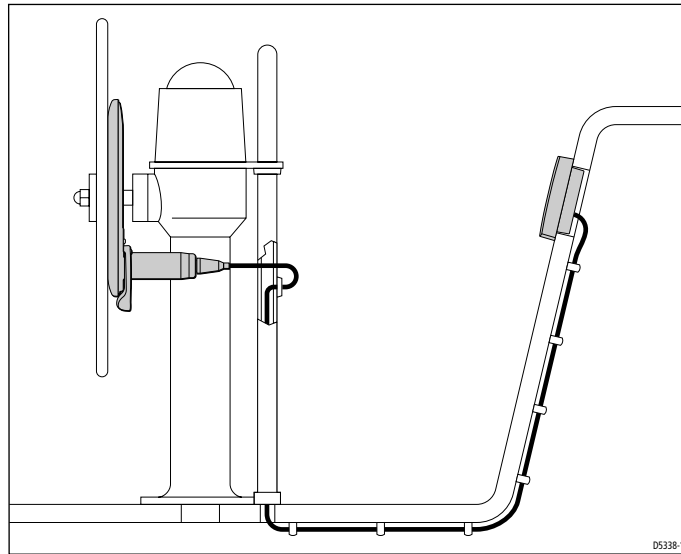

3. Run the drive cable back to the control unit and connect the two cores to the **Drive** terminals as shown.

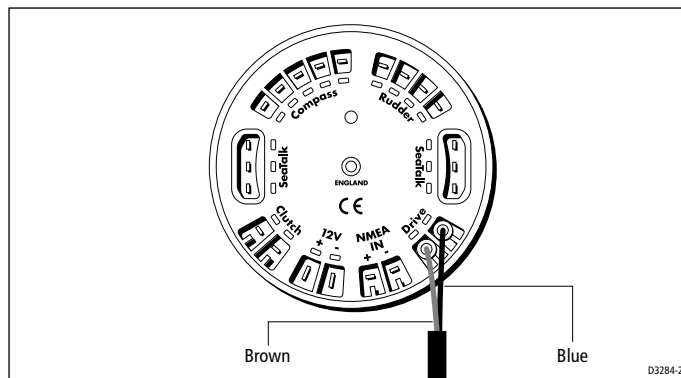

5.6 Rudder position sensor (wheel pilot)

The rudder position sensor connects directly to the boat's tiller arm or quadrant. Installing the sensor involves five main steps:

- ensuring correct alignment
- securing the sensor to the boat
- attaching the sensor to the tiller arm
- checking alignment
- connecting to the control unit

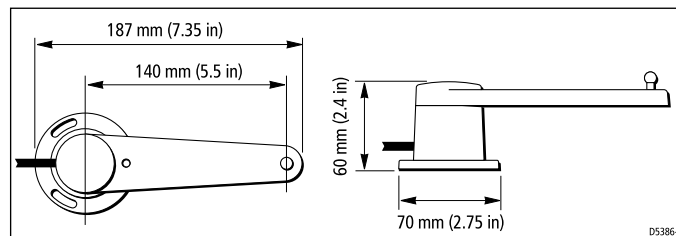

Ensuring correct alignment

CAUTION:

Take care to ensure correct rudder sensor alignment. If the sensor is not correctly aligned, the autopilot system will not perform accurately.

Vertical alignment

When viewed from the front (as shown in the illustration below), the connecting rod should be as level as possible, so the ball-joints at each end are level. It should also remain parallel to the tiller arm's plane of rotation at all times.

Note: *If misalignment exceeds $\pm 5^\circ$ the ball-joints will bind or fail.*

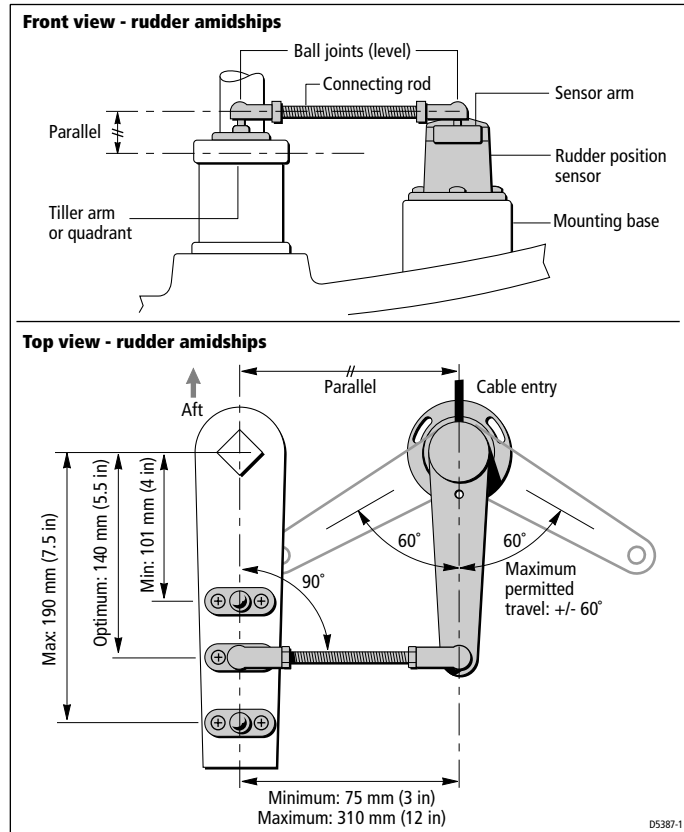

Horizontal alignment

When viewed from above (as shown in the illustration above):

- the sensor arm must be between 75 mm (3 in) and 310 mm (12 in) from the tiller arm
- with the rudder amidships, the sensor arm should be at 90° to the connecting rod and directly opposite the cable entry point on the sensor body
- when the rudder moves from hardover to hardover:
 - the sensor arm and the tiller arm must remain parallel to each other at all times
 - sensor arm movement must not exceed +/- 60°: if the steering system drives the sensor arm beyond these limits it will damage the rudder position sensor

Securing the sensor to the boat

Location

Mount the rudder position sensor on a suitable base alongside the rudder stock and tiller arm.

Note: *If necessary, you can install the sensor upside down. If you mount the sensor in this way, you must swap the red and green cable connections at the control unit.*

Securing the rudder position sensor

1. Hold the sensor in place, mark the mounting holes, then remove the sensor (if required, use the template supplied).
2. Drill the pilot holes using a 3 mm ($\frac{1}{8}$ in) drill bit.
3. Attach the sensor to the mounting base using the three self-tapping screws supplied (pan-head No 8 x $\frac{3}{4}$ inch).

Note: *To make **minor** adjustments to the sensor alignment, loosen the screws, rotate the sensor body, then re-tighten the screws.*

Attaching the sensor to the tiller arm

Attaching the tiller pin to the tiller arm

1. For optimum performance, mount the tiller pin on the tiller arm 140 mm (5.5 in) from the rudder stock center line.

Note: *If necessary, you can fit the tiller pin anywhere between 101 mm (4 in) and 190 mm (7.5 in) from the rudder stock. This will not affect autopilot performance, but will slightly alter the scaling of the rudder angle display shown on the control unit.*

2. Hold the tiller pin in place (either along or across the tiller arm), mark the mounting holes then remove the tiller pin.
3. Drill pilot holes using a 3 mm ($\frac{1}{8}$ in) drill bit.
4. Attach the tiller pin to the tiller arm using the two self-tapping screws supplied (countersunk No 8 x $\frac{3}{4}$ inch) or suitable bolts, nuts and lock washers.

Attaching the connector rod

1. Use a hacksaw to cut the threaded connector rod to length.
2. Screw the lock nuts onto the rod and then the ball-pin sockets.
3. Press the sockets onto the pins on the sensor arm and tiller pin.

Note: To give the precise rudder position, the rudder sensor has a built-in spring to remove any free play in the linkage to the tiller.

Checking alignment

Move the rudder from hardover to hardover and check that at all rudder angles:

- all moving parts of the sensor remain free from any obstructions
- the sensor and connecting rod remain accurately aligned
- the ball joints do not bind

Connecting to the control unit

1. The rudder position sensor is supplied with 10 m (32 ft) of cable. Route the cable to the control unit, taking into account the EMC installation guidelines (*page 36*).
2. Connect the four cores of the cable (color for color) to the **Rudder** terminals on the control unit as shown.

Note: If the standard cable is not long enough, your Raymarine dealer can supply a 10 m (30 ft) extension cable (part number: D173).

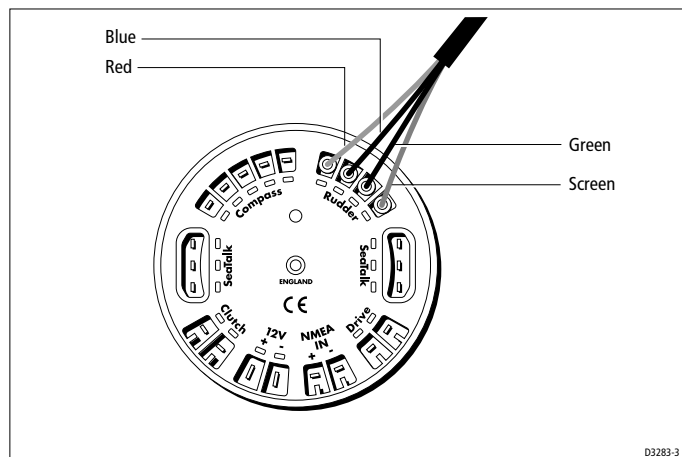

D3283-3

Chapter 6: Setting-up the ST4000+

When you have installed the system, you need to check that the system is wired correctly and set up to suit your type of boat.

This chapter provide instructions for the following post-installation procedures:

Note: *You can perform further customization after the sea trial, as described in Chapter 7: Customizing the ST4000+.*

6.1 Functional test

Switch on

1. When you have installed your ST4000+ autopilot system, switch on the main power breaker.
2. If the control unit is active and the system operating, the control unit will beep and display the pilot type (4000 WHL or 4000 TILL).

CAUTION: Wheel drive systems

One second after power-on the wheel pilot will drive to starboard for three seconds. This is to allow even wear on the drive belt.

3. After displaying the pilot type for two seconds, the control unit will then display the Standby screen.

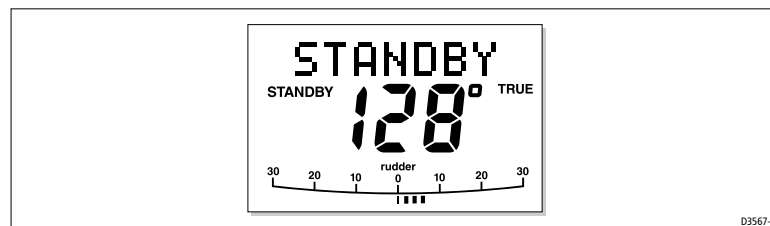

Troubleshooting

- If the head does not beep, check the fuse/circuit breaker.
- If the display shows the SEATALK FAIL alarm message, check the SeaTalk connections.

Autopilot steering direction

The autopilot steering direction defines which way the autopilot applies helm when you press a course change key or when the boat goes off course.

Check the autopilot steering direction as follows:

1. **Wheel Pilot:** Engage the wheel drive clutch by rotating the clutch lever clockwise so it engages fully onto the locating pip.
- Tiller Pilot:** Place the pushrod end over the tiller pin. If necessary, use the **-1**, **+1**, **-10** or **+10** keys to extend or retract the pushrod.

WARNING: Wheel drive clutch

Always reach **AROUND** (not through) the wheel to operate the wheel drive clutch lever.

6 Setting-up the ST4000+

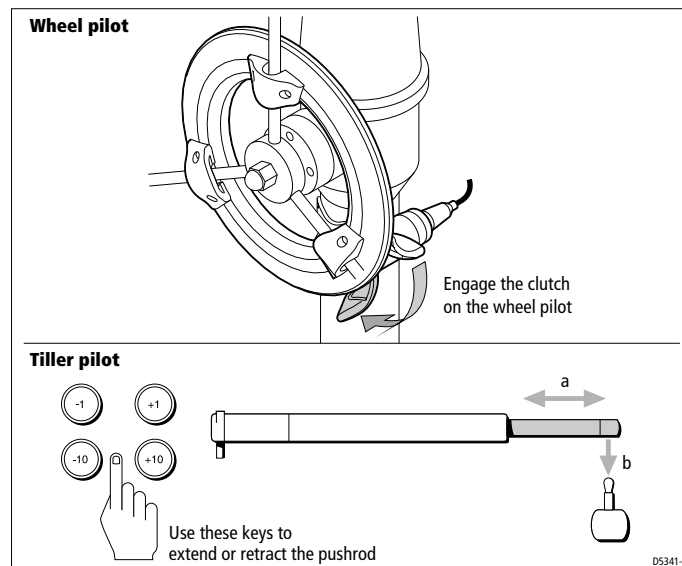

2. Press the **+10** key. The helm should move to produce a turn to starboard.

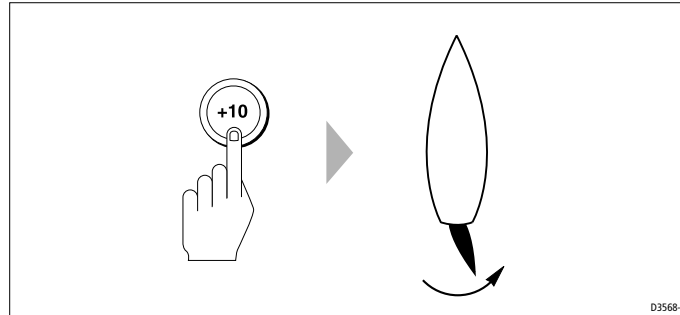

3. If the helm produces a turn to port, reverse the drive connections on the back of the control unit.

Checking connections

Navigation interface (GPS, Decca, Loran)

If you have connected the ST4000+ to a NMEA navigator, check the links by displaying the default data pages (XTE, BTW and DTW):

- press **disp** to display the first data page, and check that this page shows the expected data
- press **disp** again to check the other data pages

If the display shows dashes instead of data values, the cause could be one or more of the following:

- a cabling error: check for an open circuit, short circuit or reversed wires
- the navigator is not configured to transmit the required data format
- the navigator is receiving signals that are too weak for reliable navigation: refer to the navigator handbook for further action

Wind instrument interface

If you have connected the ST4000+ to a NMEA or SeaTalk wind instrument, check the links as follows:

- Press **standby** and **auto** together:
 - the ST4000+ should display the Wind Vane mode screen, with the locked wind angle and locked heading as shown

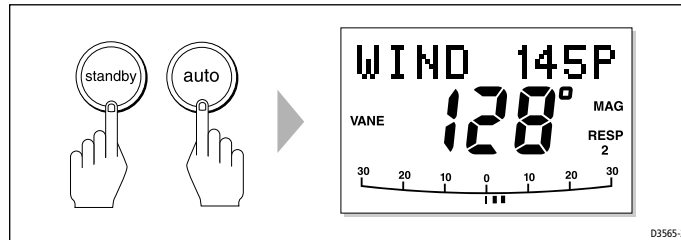

- if the ST4000+ is not receiving wind data, it will display a NO DATA message: check the wind instrument and connections

SeaTalk interface

If you have connected the ST4000+ to other SeaTalk instruments or control units, check the links as follows:

1. Press **standby**.
2. Select display lighting level 3 (LAMP 3) on any other SeaTalk instrument or control unit.

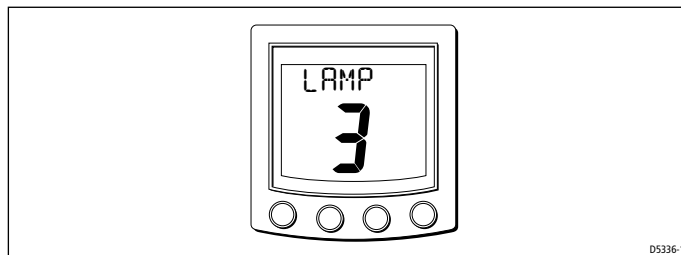

3. The ST4000+ should immediately respond by switching on its display lighting:
 - if the display lighting does not switch on, there is a fault in the SeaTalk cabling between the ST4000+ and the other instruments/control units

6.2 Check rudder sensor operation (if fitted)

Note: *This procedure is only required if you have fitted a rudder position sensor to a wheel pilot system.*

If you have fitted a rudder position sensor to a wheel pilot, before commencing the initial sea trial you must make sure that it senses rudder movement in the correct way and is aligned with the rudder:

1. Press the **-10** or **+10** key to move the helm to check that the rudder bar display moves in the same direction as the sensor arm:
 - if the display moves in the opposite direction, swap the red and green cables at the control unit (see page 74)
2. When you have done this, use the **-1**, **+1**, **-10** and **+10** keys to move the helm to its center position.
3. Check the rudder bar display – the rudder angle should be within $\pm 7^\circ$ of center.

If necessary, bring the rudder angle to within $\pm 7^\circ$ of the center by

- loosening the mounting bolts on the rudder position sensor
 - rotating the base of the sensor until the reported rudder angle is as close to zero as possible
 - re-tightening the bolts
4. When the offset is less than $\pm 7^\circ$, use the rudder alignment (ALIGN RUD) setting in Dealer setup (see page 96) to accurately align the display and helm.

Note: *You cannot use the rudder alignment (ALIGN RUD) setting to correct an offset of more than $\pm 7^\circ$.*

5. Calibrate the rudder limits using the rudder limit (RUD LIMIT) setting in Dealer setup:
 - manually set the rudder to each end stop (port and starboard): for each direction, use the rudder bar on the display to determine the end-stop angle
 - access the rudder limit screen (RUD LIMIT)
 - set the autopilot rudder limit so that it is 5° less than the smallest (port or starboard) mechanical end stop angle



6.3 Initial sea trial

When you have checked that the system is functioning correctly, you must complete the setup by taking the boat on a short sea trial to:

- correct the compass deviation
- adjust the heading alignment
- check autopilot operation
- adjust the rudder gain

Note: *The ST4000+ has built-in calibration so you can fine tune it to suit your boat, its steering system and its dynamic steering characteristics. So you can perform the initial sea trial, we calibrate the unit at the factory to provide safe and stable autopilot control for the majority of boats.*

You should perform the initial sea trial:

- when you have successfully completed all of the installation, functional tests and rudder sensor checks
- before making any other changes to default calibration settings: check and, if necessary, reset the values to the recommended levels described in *Chapter 7: Customizing the ST4000+*
- in conditions of light wind and calm water, so you can assess autopilot performance without the influence of strong winds or large waves
- in waters that are clear of any obstructions

Note: *You can return to hand steering at any time during the sea trial by disengaging the wheel drive clutch, or removing the tiller drive pushrod from the tiller pin.*

EMC conformance

Always check the installation before going to sea to make sure that it is not affected by radio transmissions, engine starting etc.

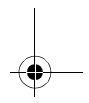
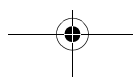
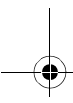

Correcting the compass deviation

Depending on your boat type, deviating magnetic fields can cause compass errors up to 15°. The correction procedure reduces these errors to a few degrees, so you **MUST** perform this procedure as the first item in your initial sea trial. The ST4000+ will then automatically correct the fluxgate compass for most deviating magnetic fields.

CAUTION:

If you fail to complete the deviation correction, your autopilot's performance will be impaired on some compass headings.

The deviation correction procedure (swinging the compass) involves turning your boat in slow circles so the ST4000+ can determine the deviation and calculate any correction required. You must carry out this procedure in calm conditions and preferably on flat water.

Performing the automatic deviation correction

1. Make sure the autopilot is in Standby but with the drive disengaged.
2. Press and hold the **standby** key for 2 seconds to display the User setup entry page (SET UP).

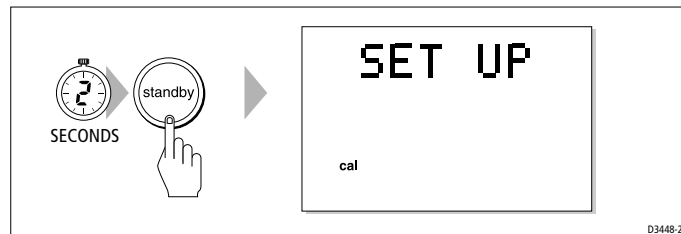

Note: If you see CAL LOCK, you need to turn off the calibration lock in Dealer Setup (see page 96).

3. Press the **DISP** key so you see the SWING COMPASS page.

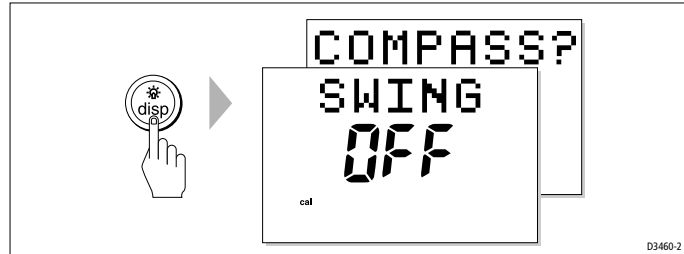

4. Press the **-1** or **+1** key to change the setting from OFF to YES. You will then see the TURN BOAT page.

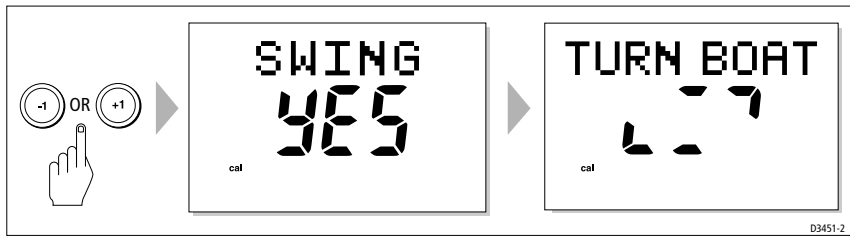

5. Keeping the boat speed below 2 knots, turn your boat in slow circles. You should take at least 3 minutes to complete each 360°.

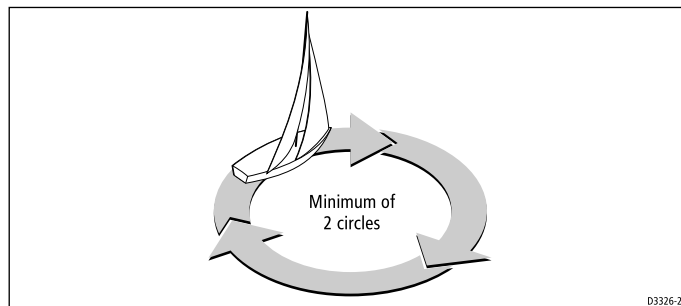

What if I turn the boat too quickly?

If you turn the boat too quickly for the autopilot to correct the compass, the screen will display a TOO FAST message. Apply less helm to turn in a larger circle.



Can I cancel the process?

You can abort the correction process by pressing the **disp** key to move onto the DEVIATION screen.

Note: *If you want to attempt deviation correction again, you can step back to the Swing Compass page or keep pressing **disp** to cycle through the calibration options until the page is displayed again. (To step back to the previous screen, press and hold the **disp** key for one second. You can only do this within two seconds of advancing to the current screen.) Repeat the procedure from step 4.*

6. Keep turning the boat until the unit beeps and displays the DEVIATION screen to indicate that compass correction has been completed successfully. This shows the maximum deviation as an average over 360° (not as an east/west value).

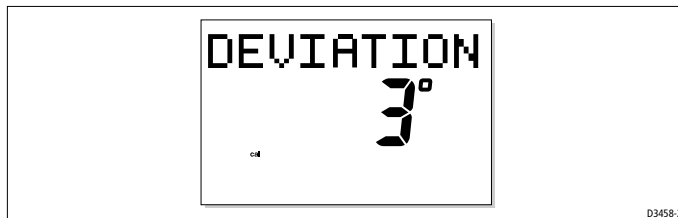

Note: *If the deviation value exceeds 15° or the display shows no deviation value, move the compass to a better location (see page 46).*

7. Press the **disp** key to move onto the heading alignment (ALIGN HDG) page.



8. Use **-1** and **+1** or **-10** and **+10** to adjust the displayed heading until it matches boat's steering compass or a known transit bearing.

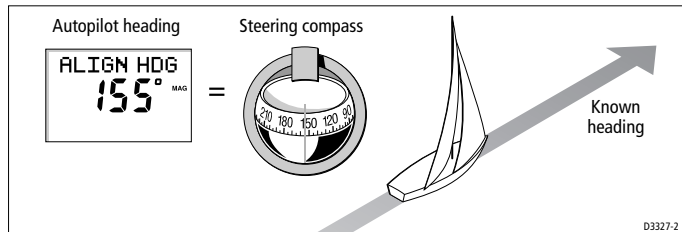

9. Press and hold **standby** for 2 seconds to exit calibration and save the new settings.

Note: Setup options are always saved on exit.

Adjusting the heading alignment

You should always check the compass alignment after completing the deviation correction procedure (swinging the compass). After you have completed the initial deviation correction procedure, you can make adjustments to the alignment as often as you wish without swinging the compass again.

Although the compass deviation correction procedure removes most of the alignment error, small errors (of the order of a few degrees) will probably remain, that vary depending on the heading.

Ideally, you should check the heading reading against a number of known headings, plot a deviation curve, and determine the heading alignment value that will give the lowest **average** alignment error. You can then enter this value on the Heading Alignment screen, as described above.

If the average heading error is more than 5°, you should perform the compass deviation correction procedure again, circling slower and in more favorable conditions.

Checking autopilot operation

After calibrating the compass, familiarize yourself with autopilot operation:

1. Steer onto a compass heading and hold the course steady.
2. **Wheel Pilot:** Engage the wheel drive clutch.
Tiller Pilot: Place the push rod end over the tiller pin.
3. Press **auto** to lock onto the current heading. The autopilot should achieve a constant heading in calm sea conditions.
4. Use the **-1**, **+1**, **-10** and **+10** keys to check that the autopilot alters the course to port and starboard in multiples of 1° and 10°.
5. Press **standby** and disengage the autopilot to return to hand steering:
 - **Wheel Pilot:** disengage the wheel drive clutch by rotating the clutch lever anti-clockwise
 - **Tiller Pilot:** remove the drive unit from the tiller pin (if required, retract the push rod using **-1**, **+1**, **-10** and **+10** keys)

Checking the rudder gain

The rudder gain level set at the factory will provide stable control for initial sea trials. However, boats can vary widely in their response to helm, and by adjusting the rudder gain you can improve the autopilot's steering characteristics.

Complete the following test to determine whether the rudder gain is set too high or too low:

1. Sail your boat at cruising speed in clear water:
 - you will find it easiest to recognize the steering response in calm sea conditions where wave action does not mask basic steering performance
2. Switch the autopilot to Auto, then make a 40° course change by pressing the **-10** or **+10** key four times:
 - if the rudder gain is adjusted **correctly**, the 40° course change should result in a crisp turn followed by an overshoot of no more than 5°
 - if the rudder gain setting is too high, the 40° course change will result in a distinct overshoot of more than 5° (**A**)
*Correct this oversteer by **reducing** the rudder gain setting.*
 - if the rudder gain is too low, the boat's performance will be sluggish – it will take a long time to make the 40° turn and



there will be no overshoot (**B**)

Correct this understeer by **increasing** the rudder gain setting.

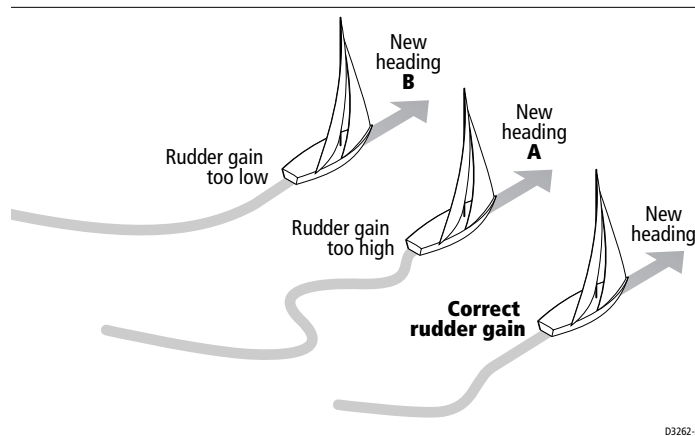

6 Setting-up the ST4000+

3. To make a temporary adjustment to the rudder gain:
 - press the **-1** and **+1** keys together for 1 second to display the rudder gain (RUDD GAIN) screen
 - then press **-1** or **+1** to change the level
 - press **disp** or wait for 5 seconds to return to the previous display and save the temporary changes
4. Repeat the test until you achieve a crisp course change with no more 5° of overshoot.

Note: Set the rudder gain to the lowest value that gives accurate course keeping. By minimizing helm movements this will reduce power consumption and wear.

5. When you have determined the correct setting, change the permanent rudder gain setting in Dealer setup (see page 94).

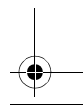
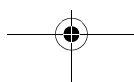
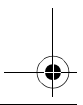
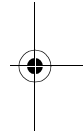

6.4 Autopilot calibration techniques

The autopilot's factory default settings will provide adequate steering for most boats. If you still experience problems with autopilot performance after completing the *Post Installation Procedures*, follow these six steps to optimize the setup for your boat.

Step 1 - Switch on ancillary equipment

Make sure you have switched on any ancillary equipment, such as a GPS providing speed over ground (SOG) and latitude (LAT) data, or a speed log providing speed through the water. This information will help the autopilot provide its best performance.

Step 2 - Apply initial settings

Enter the Dealer setup mode (see *page 94*) and apply the following initial settings.

Calibration setting	Power boat	Sail boat
Calibration lock	OFF	OFF
Pilot type	Use the default setting	
Rudder gain (*see step 4)	5*	5*
Response	2	1
Turn rate limit	Use the default setting	
Rudder alignment	Set as described on <i>page 79</i>	
Rudder limit	Set as described on <i>page 97</i>	
Off course alarm	Use the default setting	
AutoTrim (*see step 5)		
with rudder sensor	1*	1*
without rudder sensor	3*	3*
Drive type	Use the default setting	
Variation	Set as described <i>page 98</i>	
AutoAdapt	Set as described on <i>page 99</i>	
Latitude	Set as described on <i>page 99</i>	
AutoRelease	Use the default setting	
Rudder damping (*see step 3)	1*	1*
Cruise speed	Set as described on <i>page 100</i>	



Step 3 - Adjust the rudder damping

If you have connected a rudder position sensor to a wheel drive autopilot system, adjust the rudder damping. Check the rudder damping when your boat is moored dockside:

- press **auto** and then **+10**
- if the helm overshoots and has to drive back, or starts to hunt back and forth, you need to increase the damping level
- adjust the damping one level at a time, and always use the lowest acceptable value.

Step 4 - Adjust the rudder gain

The next step is to adjust the rudder gain, as described on *page 85*.

Step 5 - Adjust the AutoTrim setting

When there is a change in boat trim and/or sea conditions the boat will change course. The autopilot will immediately apply rudder to correct for this. However, it may not apply sufficient rudder to overcome standing helm and bring the boat fully onto course. Over a period of minutes the AutoTrim function will apply more rudder until it achieves the desired course.

Increasing the AutoTrim level reduces the time the autopilot takes to get back to the correct course. But if the AutoTrim level is too high, the boat will snake around the desired course.

You should gain experience with your autopilot before attempting to adjust the AutoTrim setting. On sail boats, you can only evaluate the effect of AutoTrim while under sail.

If you need to change the setting, increase the AutoTrim one level at a time and use the lowest acceptable value:

- **decrease** the AutoTrim level if the autopilot gives unstable course keeping and the boat 'snakes' around the desired course
- **increase** the AutoTrim level if the autopilot hangs off course for excessive periods of time

Step 6 - Further adjustments

You may need to repeat these steps over a range of sea conditions and different headings to achieve a good overall performance.

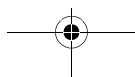
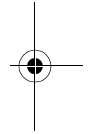

Chapter 7: Customizing the ST4000+

The ST4000+ provides calibration options that you can use to adjust the settings for the control unit, the compass and the autopilot system.

We calibrate the ST4000+ during manufacture to provide stable performance for most boats so you can perform the initial sea trial. After you have completed the initial installation and sea trial, you should not normally need to alter the Dealer setup values. However, if sailing conditions change you may need to adjust the settings.

Note: Complete the procedures described in Chapter 6: Setting-up the ST4000+ before adjusting any calibration settings.

Accessing the setup modes

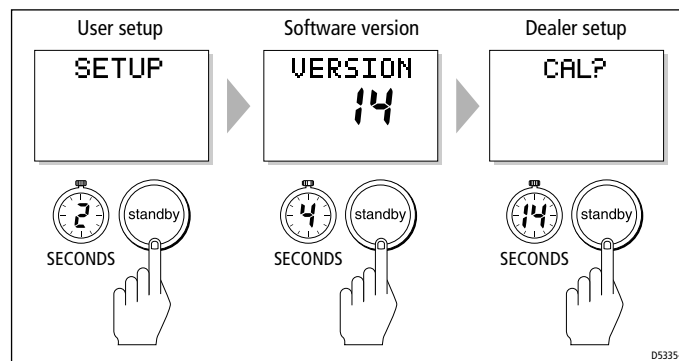

Note: See page 32 for more information about the software version screen.



7.1 User setup

User setup allows you to calibrate and align the autopilot compass, select the type of bar graph shown on the ST4000+ display, and control the information shown on the data pages.

The flowchart on the following page explains how to access User setup, scroll through the setup displays, adjust the values and quit:

- you can only access User setup from Standby mode
- if you see the CAL LOCK screen instead of the initial page, you need to turn off the calibration lock in Dealer setup (see *page 96*)
- the ST4000+ saves any new settings when you quit User setup

The rest of this section explains the settings on each screen.

Compass deviation correction (SWING COMPASS)

This screen allows you to correct the compass for deviating magnetic fields. You must perform this procedure as the first item in your initial sea trial (see *page 81* for full details).

Deviation display (DEVIATION)

This screen shows the current deviation value, calculated from the compass deviation correction procedure (see *page 81* for full details). You cannot edit this value.

Heading alignment (ALIGN HDG)

This screen allows you to align the autopilot compass with the boat's compass:

- steer your boat onto a known heading
- adjust the displayed heading using the **-1**, **+1**, **-10** and **+10** keys
- check the autopilot display on various headings and adjust as necessary (see *page 84*)

Heading mode (HDG MAG/TRU)

This screen allows you to select either magnetic or true heading mode. When the display shows heading data in normal operation, it indicates whether you have selected true or magnetic mode.

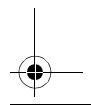
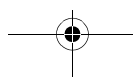
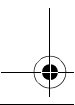

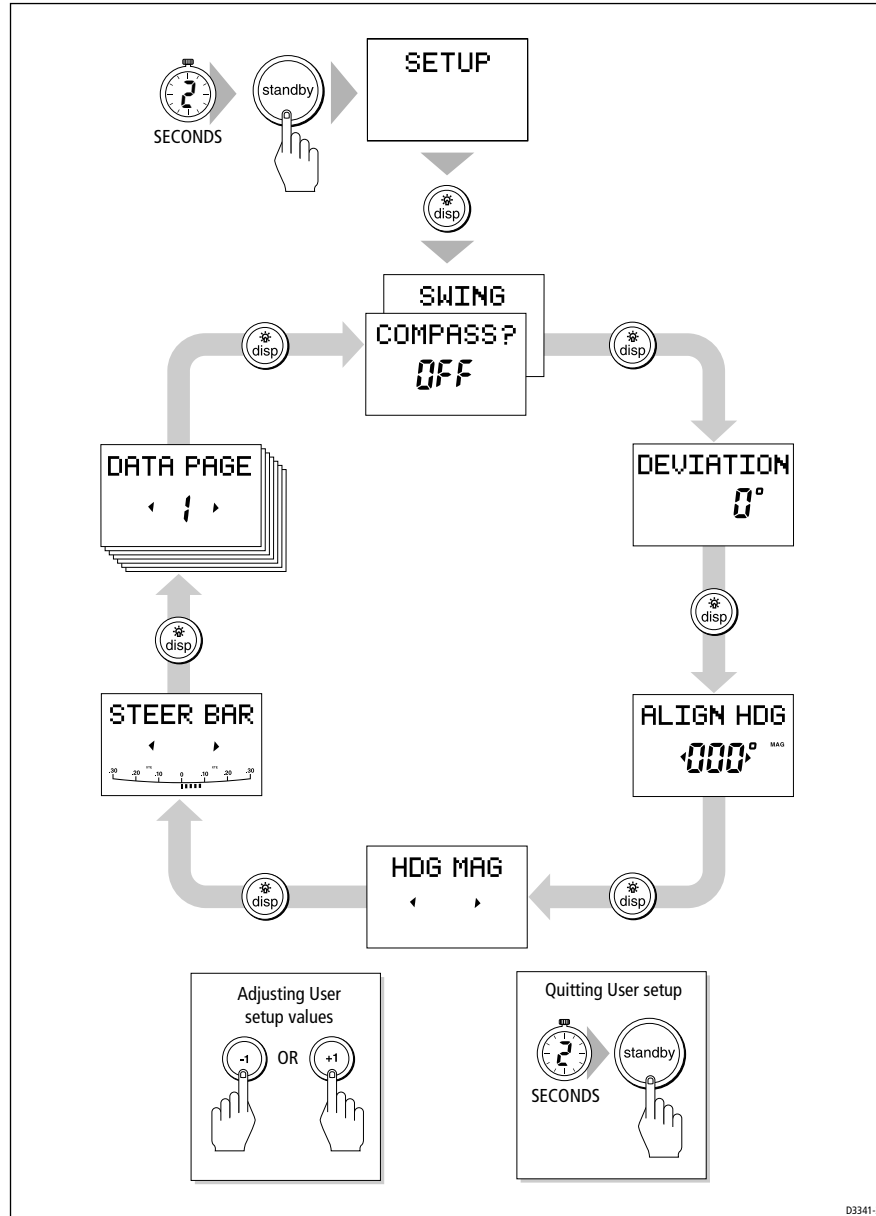

7 Customizing the ST4000+

Bar selection (RUDD BAR/STEER BAR/NO BAR)

Use this screen to select the type of bar graph shown on the display:

- **STEER BAR:** This is the default setting. It uses the bar graph to indicate different information in different operating modes:

Mode	Bar
Standby	Rudder bar (for systems with a rudder position sensor)
Auto	Heading error bar
Track	Cross track error (XTE) bar
Wind Vane	Wind angle error bar

- **RUDD BAR:** This shows the rudder position. If your system includes a rudder angle sensor, the bar graph will show the **true** rudder angle in Standby and Auto modes.

Data pages 1-7 (DATA PAGE)

The next seven User setup screens allow you to modify the settings for the data pages. These define the SeaTalk/NMEA data pages that will be available during normal operation (see *page 25*). Each setup page initially shows the title DATA PAGE. After 1 second, the text changes to the title of the data currently set for that page. The default settings are:

Data page	Default setting
1	XTE (Cross Track Error)
2	BTW* (Bearing to Waypoint)
3	DTW* (Distance to Waypoint)
4-7	NOT USED (These pages are not displayed when you scroll through the data pages during normal operation)

* Note: It is good practice to keep the BTW and DTW for display. If the autopilot receives a man overboard (MOB) message, these data pages will display the bearing and distance to the MOB location.

To change the data displayed on a data page:

- Press **disp** to move to the appropriate data page setup screen.
- For each setup page, use the **-1** or **+1** keys to scroll forwards or backwards through the available data pages (see following table).

- Press **disp** to move to the next data page you want to change, or press and hold **standby** for 2 seconds to exit and save changes.

The available pages are:

Data	Displayed as
Speed Knots	SPEED KTS
Log	LOG XXXX.X
Trip	TRIP XXX.X
Average Speed, Knots	AV. SPD KTS
Wind Direction	e.g. WIND PORT
Wind Speed	WIND KTS
Depth Metres*	DEPTH M
Depth Feet*	DEPTH FT
Depth Fathoms*	DEPTH FA
Heading	HEADING
Water Temperature, Degrees C*	WATER °C
Water Temperature, Degrees F*	WATER °F
Course Over Ground	COG
Speed Over Ground, Knots	SOG KTS
Cross Track Error	XTE
Distance to Waypoint	DTW
Bearing to Waypoint	BTW
Rudder Gain	RUDD GAIN
Response	RESPONSE
Watch	WATCH - used to control the Watch timer
Universal Time Coordinated	UTC
NOT USED	Page not displayed (Any data page set to NOT USED is not displayed when you scroll through the data pages during normal operation)

*Note: There are 3 depth pages (meters, feet and fathoms) and 2 water temperature pages (°C and °F). The ST4000+ will display the water temperature or depth data in the units defined by page you select.

7.2 Dealer setup

Dealer setup allows you to customize the autopilot to your boat. However, the factory default settings will provide safe performance for the initial sea trial, and fine tuning is not normally required.

The flowchart on the next page explains how to enter Dealer setup, scroll through the setup displays, adjust the values and quit:

- you can only access Dealer setup from Standby mode
- the ST4000+ saves any new settings when you quit Dealer setup

The rest of this section explains each of the Dealer setup screens.

The following table lists the settings you can adjust. If you change any of the settings, record them in this table.

Feature	Options/Range	Default setting	New setting
Calibration lock	ON or OFF	OFF	
Pilot type	4000 WHL or 4000 TILL	wheel: 4000 WHL tiller: 4000 TILL	
Rudder gain	1 to 9	5	
Response	1 (AutoSeastate on) or 2 (AutoSeastate off)	1	
Turn limit	5° to 40°	40°	
Rudder alignment	-7 to +7	0	
Rudder limit	15 to 40	tiller 15 wheel 30	
Off course alarm	15° to 40°	20°	
AutoTack angle	40° to 125°	100°	
AutoTrim	OFF, 1 to 4	3	
Drive type	1 (mechanical drives) or 2 (hydraulic drives)	1	
Variation	-30° to +30°	0°	
AutoAdapt	N, S, OFF	OFF	
Latitude	0° to 80°	0°	
Rudder damping	1 to 9	1	
Cruise speed	4 to 60	6	

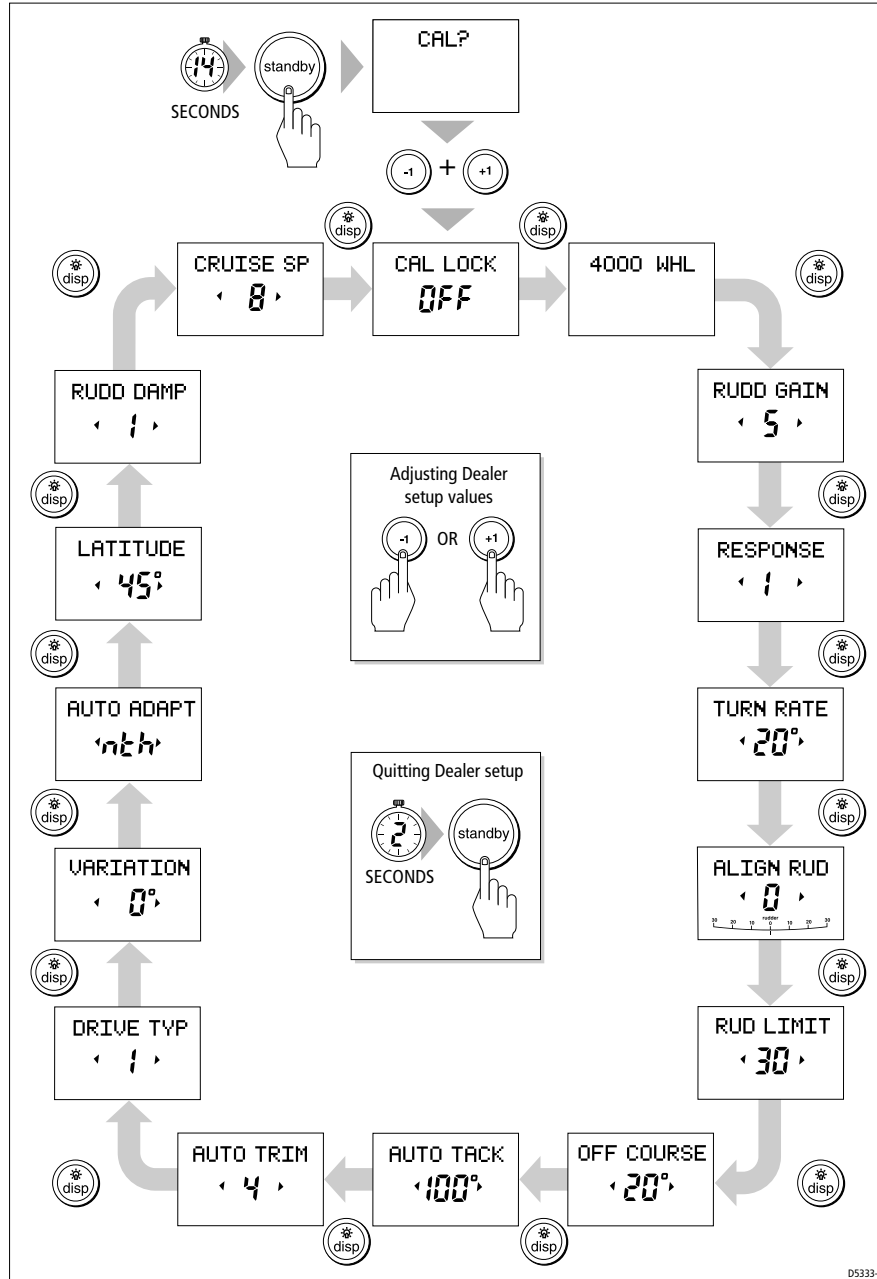



Calibration lock (CAL LOCK)

Calibration lock controls whether it is possible to access User setup or display the software version. It is intended for charter boat users.

Pilot type (4000 WHL/TILL)

Retain the default setting of 4000 WHL for wheel drive systems, and 4000 TILL for tiller pilots.

Rudder gain (RUDD GAIN)

This is the permanent power-on rudder gain setting. Follow the procedure on *page 85* to adjust this value to the setting that gives the best steering performance. You can make temporary changes to this rudder gain value during normal operation (see *page 10*).

Response level (RESPONSE)

This is the permanent power-on response setting. You can make temporary changes to this response level setting during normal operation (see *page 9*).

Turn limit (TURN RATE)

This limits your boat's rate of turn under autopilot control. The value must be within the range 5° to 40°.

Rudder alignment (ALIGN RUD)

Set this option if you have connected a rudder position sensor to your wheel pilot system:

1. Manually center the helm.
2. The rudder bar graph at the bottom of the screen indicates the rudder angle as determined by rudder position sensor:
 - adjust the offset, using the **-1** and **+1** keys, until the rudder bar graph shows the rudder position as central

Note: *The offset must be within -7° to +7°. If the offset is too great to adjust on screen, you will need to improve the alignment of the rudder position sensor (see page 74) and then repeat steps 1 and 2.*



Rudder limit (RUD LIMIT)

Use the rudder limit function to set the limits of autopilot rudder control just inside the mechanical end stops. This will avoid putting the steering system under unnecessary load. The adjustment range is from 15° to 40° of rudder movement.

If your boat is fitted with a rudder position sensor, set the autopilot rudder limit as follows:

1. Manually set the rudder to each end stop (port and starboard): for each direction, use the rudder bar on the display to determine the end-stop angle
2. Access the rudder limit screen (RUD LIMIT).
3. Set the autopilot rudder limit so that it is 5° less than the smallest (port or starboard) mechanical end stop angle.

Off course alarm (OFF COURSE)

This feature controls the alarm that warns you if the autopilot is unable to maintain its set course. The alarm operates if the pilot strays off course by more than the alarm angle limit for more the 20 seconds. The value must be within 15° to 40°, and you can adjust it in 1° steps.

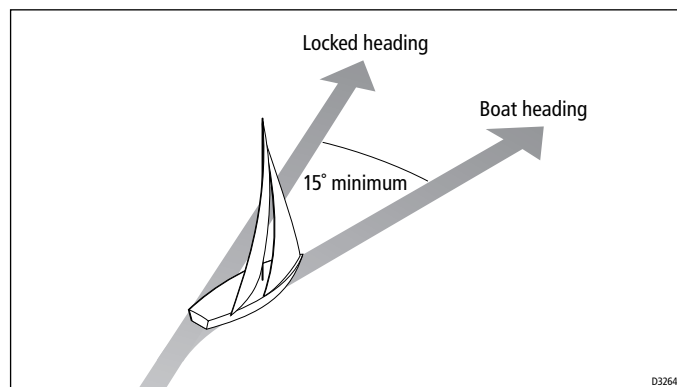

AutoTack angle (AUTOTACK)

The AutoTack angle is the angle through which the boat turns when you select automatic tack (see *page 8*). The value must be within the range 40° to 125°, and you can adjust it in 1° steps.



AutoTrim (AUTOTRIM)

The AutoTrim setting determines the rate at which the autopilot applies 'standing helm' to correct for trim changes caused by varying wind loads on the sails or superstructure. The possible settings are:

Setting	Effect
Off	No trim correction
1	Slow trim correction
2	Medium trim correction
3	Rapid trim correction
4	Very rapid correction

The default setting (Level 3) should provide optimum performance with the ST4000+ autopilot. However, depending on the boat's dynamic stability, an incorrect rate of trim application may result in poor course keeping due to autopilot instability. After gaining experience with the ST4000+, you may wish to change the setting.

You must evaluate the effect of the setting while under sail:

- **decrease** the AutoTrim level if the autopilot gives unstable course keeping and the boat 'snakes' around the desired course
- **increase** the AutoTrim level if the autopilot hangs off course for excessive periods of time

Drive type (DRIVE TYP)

The drive type setting controls how the autopilot drives the steering system. Retain the default setting (DRIVE TYP 1) for mechanically driven boats.

Magnetic variation (VARIATION)

If required, set this to the level of magnetic variation present at your boat's current position – indicated as east (E) or west (W). The ST4000+ sends this variation setting to other instruments on the SeaTalk system, and it can be updated by other SeaTalk instruments.

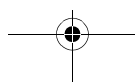

AutoAdapt (AUTOADAPT)

The patented AutoAdapt feature allows the ST4000+ to compensate for heading errors at higher latitudes, which are caused by the increasing dip of the earth's magnetic field.

The increased dip has the effect of amplifying rudder response on northerly headings in the northern hemisphere, and on southerly headings in the southern hemisphere.

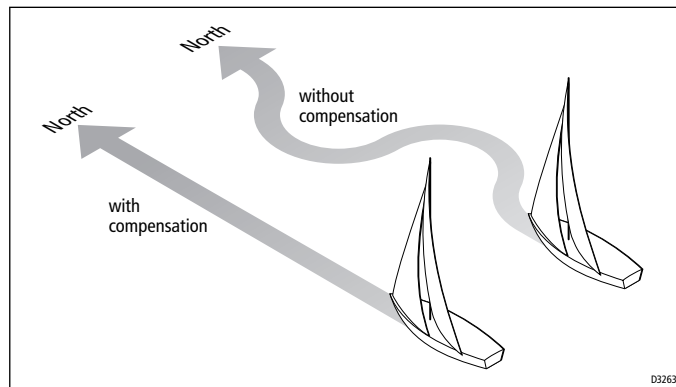

1. Set AutoAdapt to:
 - nth (north) in the northern hemisphere
 - Sth (south) in the southern hemisphere
2. You then need to enter your current latitude in the next setup screen (LATITUDE), so that the ST4000+ can provide accurate course keeping by automatically adjusting the rudder gain depending on the heading.

Latitude (LATITUDE)

The ST4000+ only displays this screen if you have set AutoAdapt to nth or Sth.

Use the **-1** and **+1** keys to set the value to your boat's current latitude, to the nearest degree.

Note: *If valid latitude data is available via SeaTalk or NMEA, the ST4000+ will use this data instead of the calibration value.*

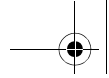

Rudder damping (RUDD DAMP)

Set this option if your system includes a rudder position sensor and the drive 'hunts' when trying to position the rudder. Increasing the rudder damping value will reduce hunting.

Check the rudder damping when your boat is moored dockside:

- press **auto** and then **+10**
- if the helm overshoots and has to drive back or starts to hunt back and forth, you need to increase the damping level
- adjust the damping one level at a time, and always use the lowest acceptable value.

Cruise speed (CRUISE SP)

Set the cruise speed to the boat's typical cruising speed. If both the boat's speed through the water and speed over ground are unavailable via SeaTalk or NMEA, the autopilot will use the cruise speed when computing course changes.

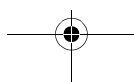
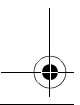
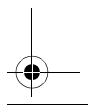
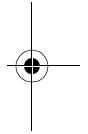

Specifications

ST4000+ autopilot system

Nominal supply voltage:	12 V DC
Operating voltage range:	10 V to 15 V DC Note: reduced voltages will severely degrade drive performance.
Autopilot power consumption	Standby: 0.72 W Auto: 10 W at 25% duty cycle (depending on boat trim, helm load and sailing conditions)
CE approvals:	Autopilot system conforms to: 89/336/EC (EMC), EN60945:1997 Compass and rudder position sensor: 94/25/EC, EN28846:1993

Control unit

Operating temperature:	0 °C to +70 °C (32 °F to 158 °F)
Water protection:	waterproof to CFR46
Overall dimensions:	width: 110 mm (4.33 in) height: 115 mm (4.53 in) depth: 41 mm (1.62 in) (see next page for other dimensions)
Keypad:	Eight button illuminated keypad
Liquid Crystal Display (LCD):	shows heading, locked course and navigational data, data pages (as selected - see <i>page 92</i>); three brightness levels + off
Input connections:	SeaTalk, power, fluxgate compass, rudder position sensor and NMEA 0183
Output connections:	SeaTalk and motor drive

Drive unit

Maximum boat displacement:	Wheel drive: 8,500 kg (18,700 lb) Tiller drive: 6,000 kg (13,000 lb) GP Tiller Drive 7,500 kg (16,500 lb)
Helm speed:	Wheel drive: 9 rpm (designed for systems with 1–3.5 turns lock to lock) Tiller drive: 4.0 sec (lock to lock)
Operating conditions:	Wheel drive: -10 °C to +55 °C (14 °F to 131 °F); waterproof to CFR46 Tiller drive: 0 °C to +60 °C (32 °F to 140 °F)
Overall dimensions:	Wheel drive: outer diameter: 361 mm (14.2 in) depth: 171 mm (6.7 in) (without spoke clamps) Tiller drive: midstroke length: 620 mm (24.5 in); diameter: 44 mm (1.7 in) (see next page for other dimensions)

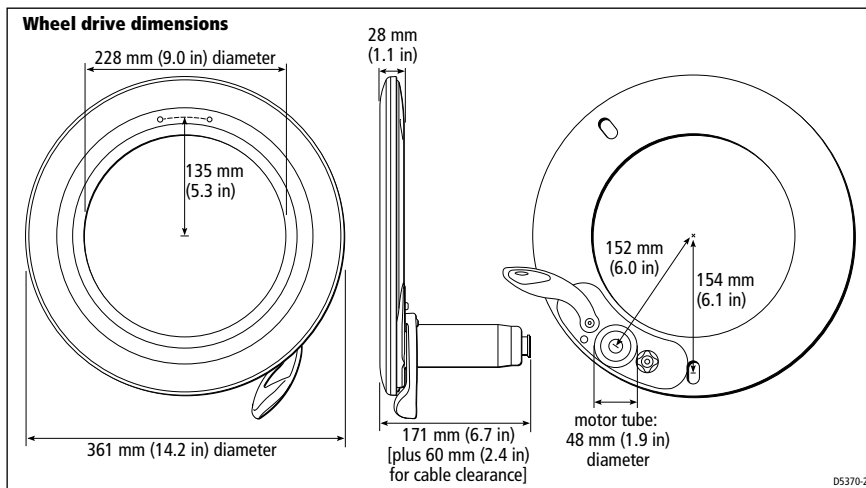
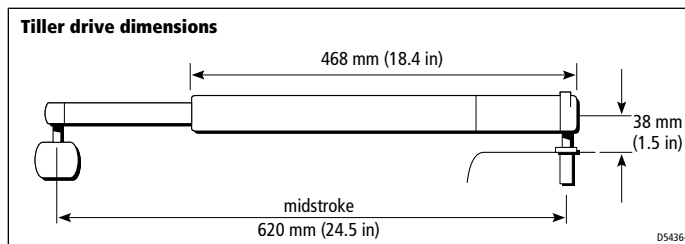
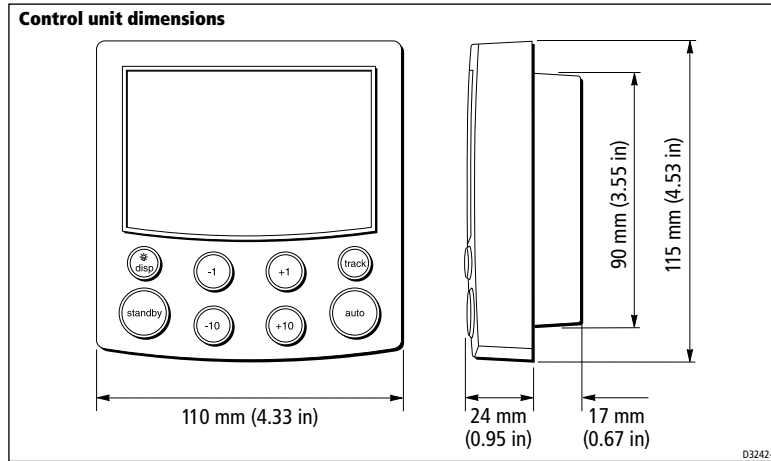

Glossary

Term	Meaning
°	Degrees
A	Amp
AutoTrim	The AutoTrim setting determines the rate at which the autopilot applies 'standing helm' to correct for trim changes caused by varying wind loads on the sails or superstructure.
AWG	American Wire Gauge
CE	Marked on products that comply with defined European Community standards
counter rudder	Counter rudder is the amount of rudder the autopilot applies to try to prevent the boat from yawing off course. Higher counter rudder settings result in more rudder being applied.
DC	Direct current
EMC (Electromagnetic Compatibility)	When powered up, all electrical equipment produces electromagnetic fields. These can cause adjacent pieces of electrical equipment to interact with one another, and this can degrade their performance. By following the EMC guidelines in this handbook, you can minimize these effects by ensuring optimum Electromagnetic Compatibility (EMC) between equipment.
Fluxgate	Standard Raymarine compass supplied with ST4000+ autopilot system
ft	Foot (1 ft = 305 mm)
GPS	Global Positioning System
Hz	Hertz (cycles per second)
in	Inch (1 in = 25.4 mm)
kg	Kilogram (1 kg = 2.2 lb)
km	Kilometre
lb	Pound (1 lb = 0.45 kg)
m	Metre (1 m = 39.4 inches)
mm	Millimeter (1 mm = 0.04 inches)
nm	Nautical mile
Nm	Newton metre
NMEA	The NMEA (National Maritime Electronics Association) protocol is an internationally accepted serial communication interface standard for sharing data between electronic equipment. Raymarine products can share information with non-SeaTalk equipment using the NMEA 0183 protocol.



Term	Meaning
oz	Ounce (1 oz = 0.028 kg)
response	The autopilot response level controls the relationship between course keeping accuracy and the amount of helm/drive activity.
rudder gain	Rudder gain is a measure of how much helm the autopilot will apply to correct course errors. The higher the setting the more rudder will be applied.
rpm	Revolutions per minute
SeaTalk	SeaTalk is Raymarine's proprietary communication system. It links the products to provide a single, integrated system sharing power and data.
SeaTalk bus	This refers to the continuous SeaTalk system connecting together a series of Raymarine units.
SM	Statute (land) mile
SSB	Single Side Band (radio)
V	Volt
VHF	Very High Frequency (radio)
W	Watt
Yaw	The boat's rate of turn

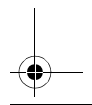
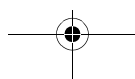
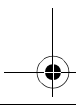
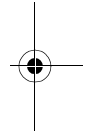
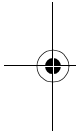

Index

A

- Adjusting autopilot performance
 - Response level 12
 - Rudder gain 13
- Alarms 14
 - DRIVESTOP 15
 - LARGE XTE 15
 - LOW BATT 16
 - MOB 17
 - NEXT WPT? 15
 - NO DATA 15
 - OFFCOURSE 14
 - SHALLOW 17
 - STLK FAIL 14
 - WATCH 16
 - WINDSHIFT 15
- Apparent wind angle
 - Adjusting 28
- Auto mode 6
- AutoAdapt 111
- Automatic deadband 12
- Automatic track acquisition 20
- AutoSeastate 12
- AutoTack 10
 - Default angle 109
 - Wind Vane mode 30
- AutoTrim
 - Default setting 110

B

- Bar graph
 - Selecting bar type 104

C

- Calibration
 - Calibration lock 108
 - Calibration techniques 98
- Changing course 8
- Clutch (wheel drive) adjustment 37
- Compass
 - Alignment 94
 - Automatic deviation correction 92

- Connections 58

- Deviation correction 102

- Deviation display 102

- Installation 55

- Steel-hulled boats 56

- Control unit installation 48

- Course changes 8

- Major course changes 10

- Cross track error (XTE) 22

- Cruise speed 112

- Customizing the autopilot 101

- Dealer setup 106

- User setup 102

D

- Data pages 31

- Setting up 104

- Deadband 12

- Dealer setup 106

- Deviation 94

- Deviation display 102

- Disengaging the autopilot 7

- Display layout 5

- Dockside procedure 90

- Dodging obstacles

- Auto mode 8

- Track mode 25

- Wind Vane mode 29

- Drive stopped alarm (DRIVESTOP) 15

- Drive type 110

E

- EMC

- Installation guidelines 46

- Servicing and safety guidelines 39

- Engaging the autopilot 6

F

- Fault finding 34

- Fluxgate compass 55

- Functional test 86

G

Gusty conditions 11

H

Heading 9

Heading alignment 102

Adjustment 95

Heading mode 102

I

Illumination 18

Initial sea trial 91

Installation 43

Compass 55

Control unit 48

EMC guidelines 46

NMEA connections 53

Power supply 51

Rudder position sensor 81

SeaTalk connections 52

Tiller drive 59

Wheel drive 70

K

Key functions 4

L

Large cross track error alarm (LARGE XTE) 15, 21, 23

LAST HDG 9

Latitude 111

Lighting 18

Low battery alarm (LOW BATT) 16

M

Maintenance 33

Man overboard alarm (MOB) 17

Manual track acquisition 21

Minimum deadband 12

N

Navigation

Data pages 31

Interface 88

NMEA

Connections 53

Data formats 54

No data alarm (NO DATA) 15

O

Off course alarm (OFFCOURSE) 14

Default angle 109

Operating modes 1

Auto mode 6

Standby mode 7

Track mode 20

Watch mode 16

Wind Vane mode 27

Operating sense 86

P

Pilot type 108

Previous heading 9

Product support 40

R

Response level 12

Default setting 108

Rudder alignment 108

Rudder bar 104

Rudder damping 112

Rudder gain 13, 96, 108

Rudder limit 109

Rudder position sensor

Installation 81

Operating sense 90

S

Sea trial 91

SeaTalk

Connections 52

Data displays 31

Fail alarm (STLK FAIL) 14

Interface 89

Servicing 39

EMC guidelines 39

Shallow alarm (SHALLOW) 17

Specifications 113

Standby mode 7

Steering bar 104

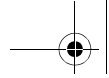

Steering direction 86
Swinging the compass 92

T

Testing autopilot operation 95
Testing the system 86
Tidal stream compensation 23
Tiller drive installation 59
Track mode 20
 Safety advice 25
Turn limit 108

U

User setup 102

V

Vane mode
 see Wind Vane mode
Variation 110

W

Watch mode
 Watch alarm (WATCH) 16
Waypoint advance alarm (NEXT WPT?)
15, 20
Waypoint arrival and advance 24
Wheel drive
 Clutch adjustment 37
 Installation 70
 Maintenance 36
Wind instrument interface 88
Wind shift alarm (WINDSHIFT) 15, 29
Wind Vane mode 27
 Adjusting apparent wind angle 28
 Previous apparent wind angle 28
WindTrim 27

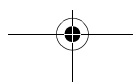
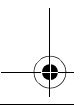
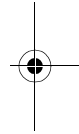
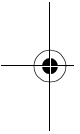

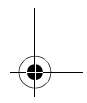
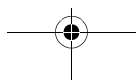
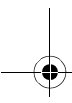
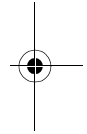
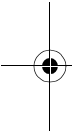
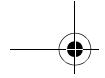

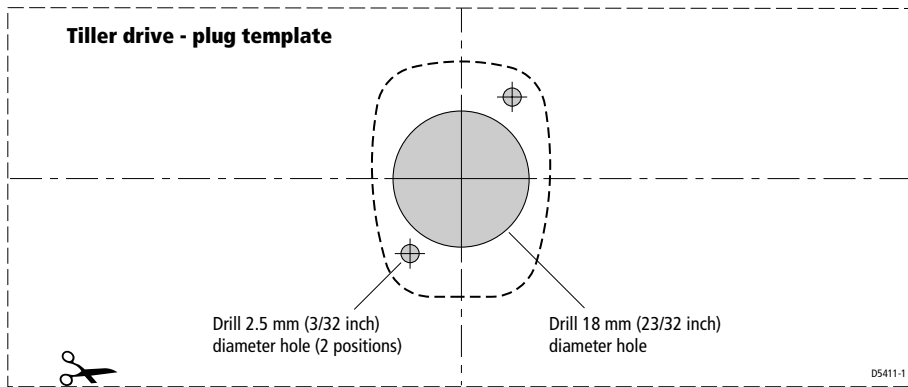
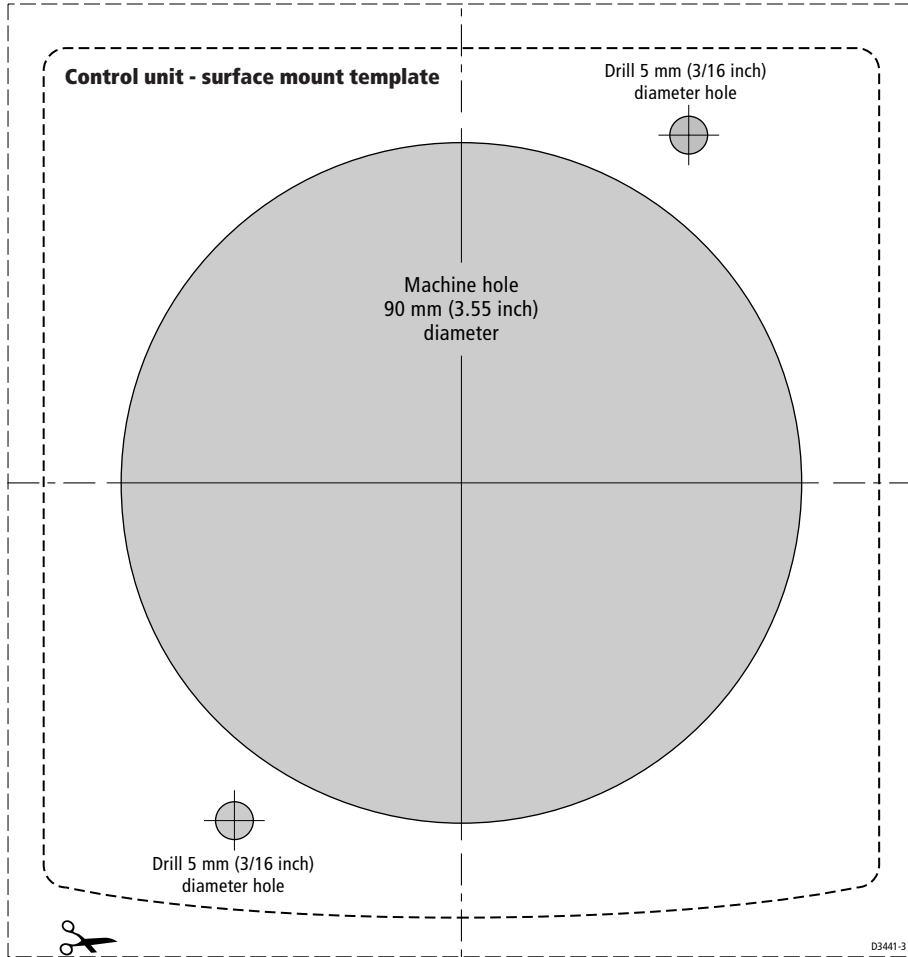

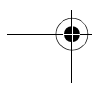
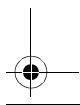
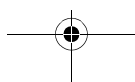
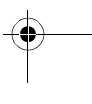
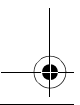
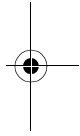
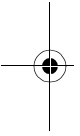
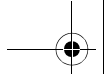

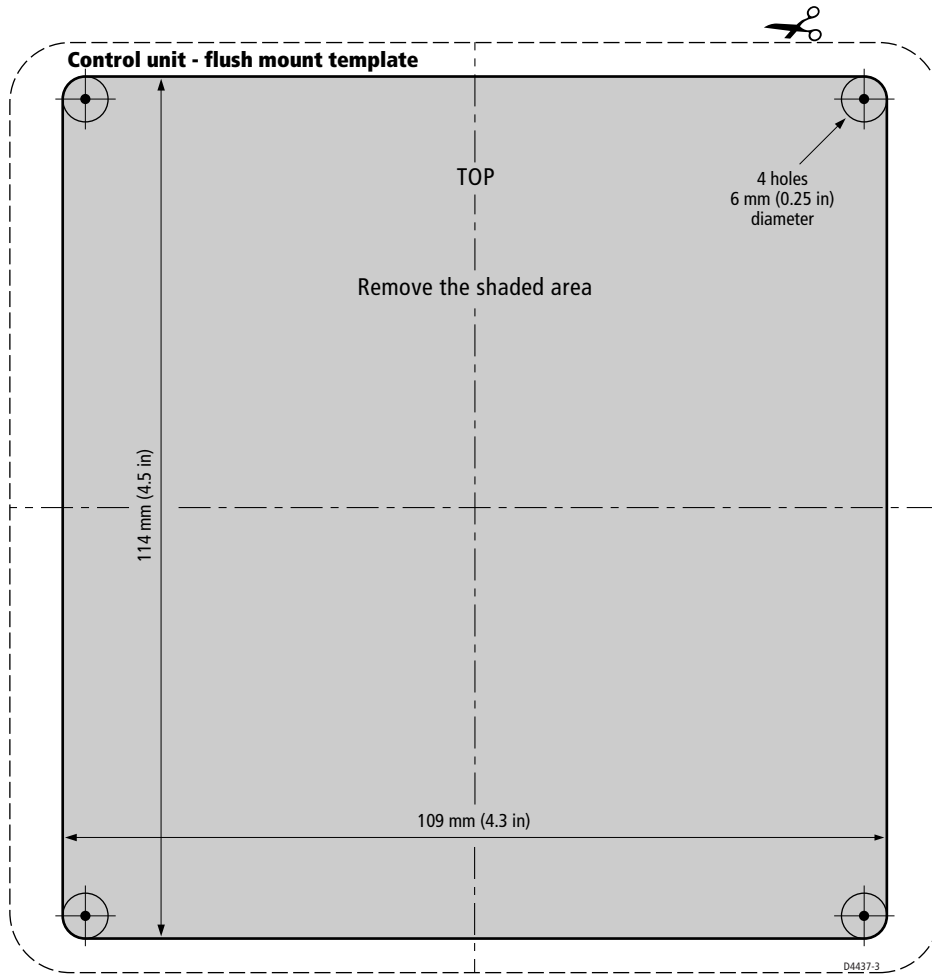

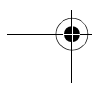
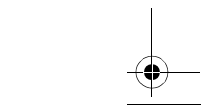
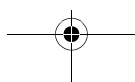
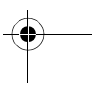
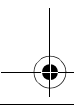
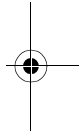
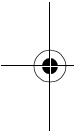
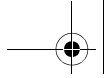

Wheel drive - spoke clamp template

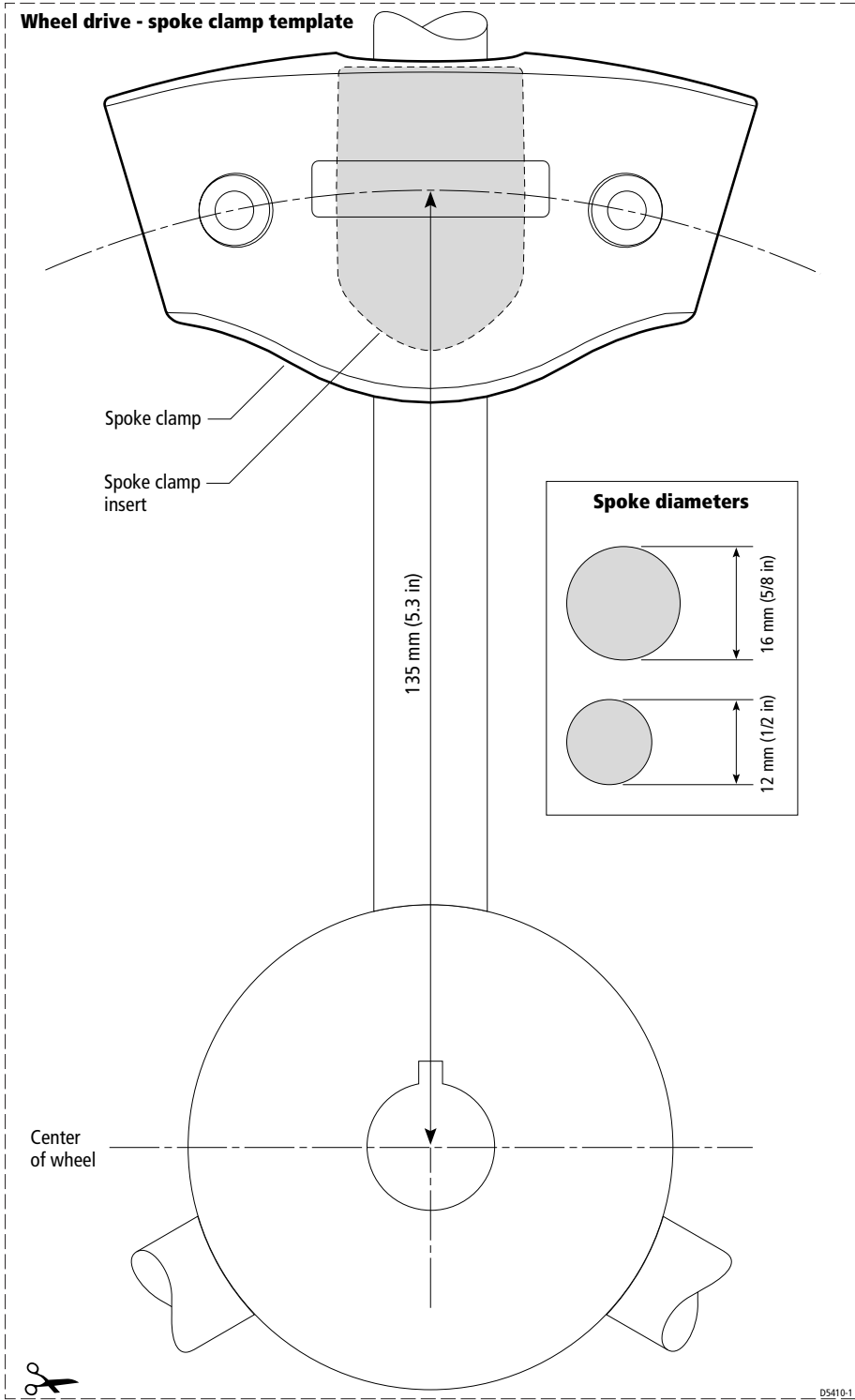

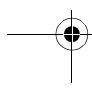
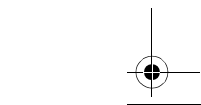
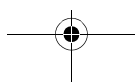
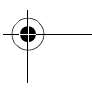
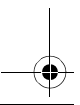
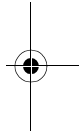
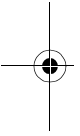
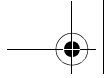

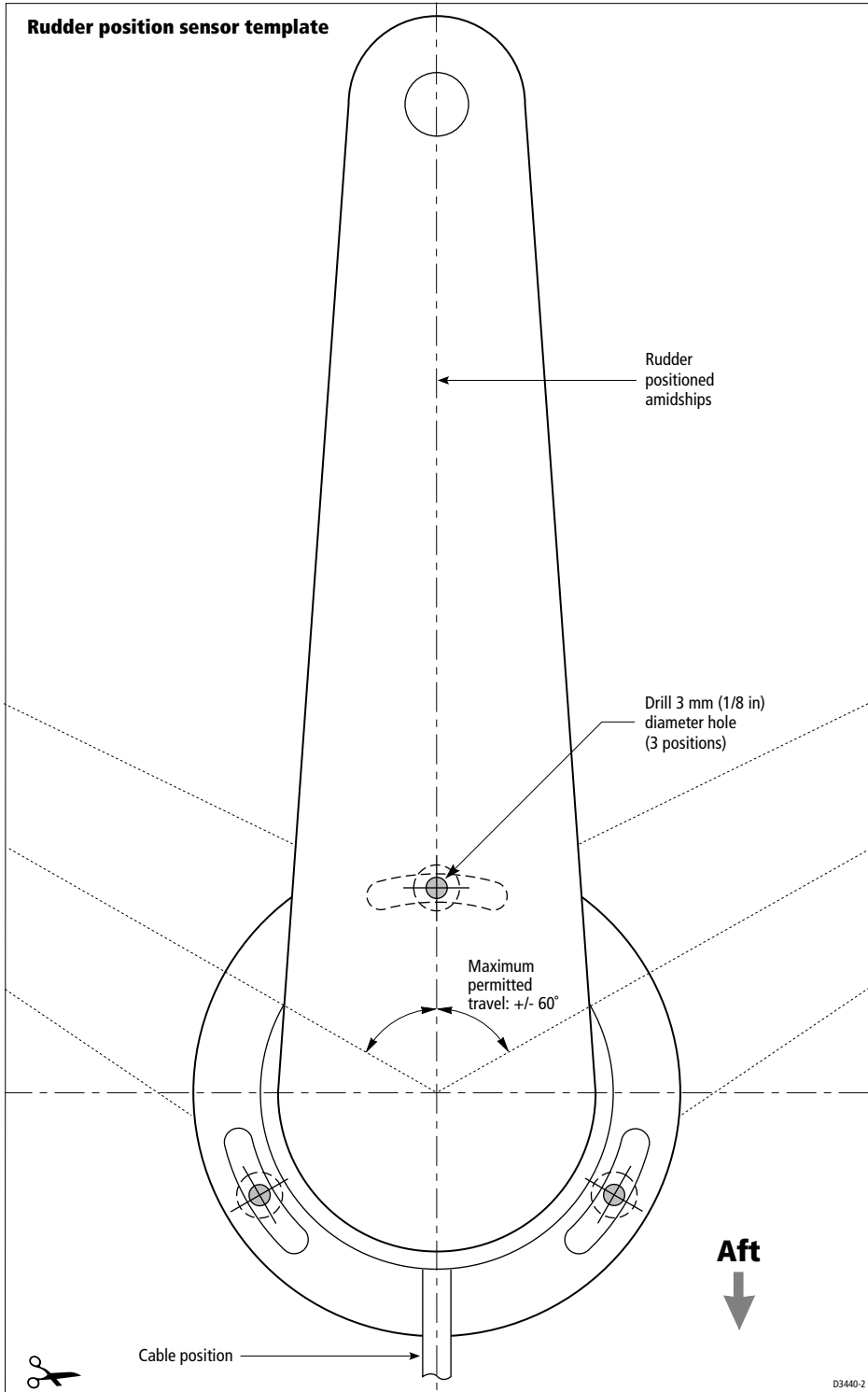

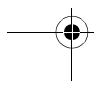
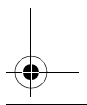
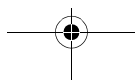
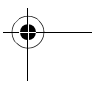
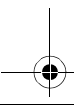
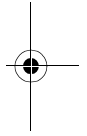
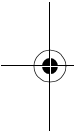
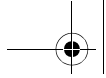



Worldwide Warranty

The Raymarine warranty terms and conditions as described below do not affect the customer's statutory rights.

In order to ensure that the equipment continues to operate efficiently and reliably, we recommend that the Owner's handbook be carefully read and particular attention is paid to advice on safe and correct operation and use of the product. We recommend that Raymarine equipment, be installed by an approved Raymarine installer.

Product warranty

Raymarine warrants each new product to be of good materials and workmanship. Raymarine, or its approved agents, will repair or exchange under warranty any parts proven to be defective in material or workmanship under normal use, for a period of 2 years (24 months) from date of sale to end user, or 30 months from date of shipment from Raymarine - whichever expires first, except as provided below.

Raymarine warranty covers the parts and labour associated with any warranty repair as described above, provided that the unit is returned to Raymarine or one of its approved agents.

Installed warranty

In addition to the Product warranty cover as described above, Raymarine will, except as provided below, authorise onboard warranty service by the nearest Raymarine approved service agent, subject to maximum mileage and travel times applicable, on products, where proof of installation, or commission by Raymarine certified installers, can be shown

The installed warranty provides for onboard repair or exchange, by Raymarine or its approved service agents, for a period of 2 years (24 months): either from date of sale of the boat to the end user - where the equipment has been installed by a Raymarine certified installer, or from commissioning of the installation by a Raymarine certified installer, or 30 months from date of shipment of the equipment from Raymarine - whichever expires first, except as provided below.

Obtaining warranty service

In the event of warranty service being required, contact Raymarine Technical Support or the nearest Raymarine approved service agent - a full list of local service agents are available on the Internet www.raymarine.com.

A suitable proof of purchase, showing date, place of purchase and serial number must be made available to Raymarine or approved service agent at the time of request for warranty service.

In cases where a Raymarine certified installer has not installed the product; i.e. Product warranty, the affected unit must be returned to the local Raymarine approved service agent, with a copy of proof of purchase and/or completed warranty card. Subject to the limitations below, the unit will be repaired/replaced at no further cost and promptly returned to the user.

In cases where the equipment has been installed by a Raymarine certified installer, (boat builder, installer dealer etc.) i.e. installed warranty, the nearest Raymarine approved service agent should be contacted (subject to mileage & travel time restrictions) and onboard service requested. The warranty card, correctly completed and stamped by the installing agent, must be available as authorisation for onboard service.

Continued . . .

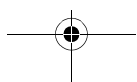

Warranty limitations

Raymarine warranty policy does not apply to equipment that has been subjected to accident, abuse or misuse, shipping damage, alterations, corrosion, incorrect and/or non-authorized service, or equipment on which the serial number has been altered, mutilated or removed.

Raymarine assumes no responsibility for damage incurred during installation or as a result of improper installation.

This warranty does not cover routine system checkouts, alignment/calibration, sea-trials or commissioning, unless required by replacement of part(s) in the area being aligned.

Raymarine does not warrant damage caused by or to other equipment, systems or components occasioned by improper or unauthorized connection, or use, of the product.

A suitable proof of purchase, showing date, place of purchase, and serial number must be made available to Raymarine or approved service agent at the time of request for warranty service.

Consumable items, including, but not limited to fuses, batteries, drive belts, radar mixer diodes, snap-in impeller carriers, impellers, impeller bearings, and impeller shaft are specifically excluded from this warranty.

All costs associated with transducer replacement, other than the cost of the transducer itself, are specifically excluded from this warranty.

Overtime/premium labour portion of services outside of normal working hours is not covered by this warranty.

When or if repairs are necessary, these products must be forwarded to a Raymarine facility or an approved Raymarine service agent, at owner's expense.

Raymarine warranty does not cover any differences in material, colouring or size between those alluded to in corporate advertising, literature or published on the Web, which are not specifically objected to at the time of delivery.

Travel costs other than auto mileage, tolls and two (2) hours travel time, are specifically excluded on all products. Travel costs, which are excluded from the coverage of this warranty, include but are not limited to: taxi, launch fees, aircraft rental, subsistence, customs, shipping and communication charges etc. Travel costs, mileage and time, in excess to that allowed must have prior approval in writing.

TO THE EXTENT CONSISTENT WITH STATE AND FEDERAL LAW:

(1) RAYMARINE SHALL NOT BE LIABLE FOR ANY INCIDENTAL, CONSEQUENTIAL OR SPECIAL (INCLUDING PUNITIVE OR MULTIPLE) DAMAGES.

(2) THIS WARRANTY IS STRICTLY LIMITED TO THE TERMS INDICATED HEREIN, AND NO OTHER WARRANTIES OR REMEDIES SHALL BE BINDING ON RAYMARINE INCLUDING WITHOUT LIMITATION ANY WARRANTIES OF MERCHANTABILITY OR FITNESS FOR A PARTICULAR PURPOSE.

All Raymarine products sold or provided hereunder are merely aids to navigation. It is the responsibility of the user to exercise discretion and proper navigational skill independent of any Raymarine equipment.



Raymarine

Factory Service Centers

United States of America

Raymarine Inc
22 Cotton Road, Unit D
Nashua, NH 03063-4219, USA

Telephone: +1 603 881 5200
Fax: +1 603 864 4756
www.raymarine.com

Sales & Order Services

Telephone: +1 800 539 5539 Ext. 2333 or
+1 603 881 5200 Ext. 2333

Technical Support

Telephone: +1 800 539 5539 Ext. 2444 or
+1 603 881 5200 Ext. 2444
www.raymarine.com

Product Repair Center

Telephone: +1 800 539 5539 Ext. 2118

UK, Europe, Middle East, Far East

Raymarine Ltd
Anchorage Park, Portsmouth
PO3 5TD, England

Telephone: +44 (0)23 9269 3611
Fax: +44 (0)23 9269 4642
www.raymarine.com

Customer Support

Telephone: +44 (0)23 9271 4713
Fax: +44 (0)23 9266 1228
www.raymarine.com

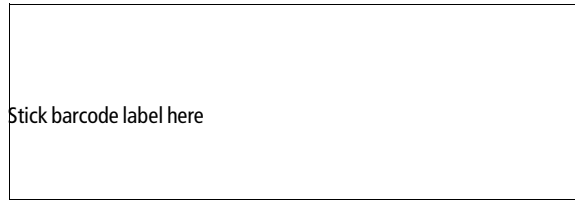

Purchased from	Purchase date
Dealer address	
Installed by	Installation date
Commissioned by	
Commissioning date	
Owner's name	
Mailing address	

This portion should be completed and retained by the owner.

